



www.grupomaya.com.es



COMPROMETIDOS
CON LA LIMPIEZA
PROFESIONAL

COMMITTED WITH THE
PROFESSIONAL CLEANING

CATÁLOGO PROFESIONAL



A REFERENT IN THE PROFESSIONAL CLEANING INDUSTRY



**Durante años,
un constante desarrollo**

**Over the years,
a continuous development**

Desde 1991, MAYA PROFESSIONAL TOOLS trabaja para ofrecer los mejores productos en el mercado de la limpieza profesional.

Como fabricante y distribuidor, MAYA PROFESSIONAL TOOLS cuenta con los mejores productos basados en la eficacia, ergonomía y sostenibilidad.

Since 1991 MAYA PROFESSIONAL TOOLS has been working to offer the best market products in the household and professional cleaning industry.

As a manufacturer and distributor MAYA products are based in the efficiency, ergonomics and sustainability.

Cada sector tiene una solución a sus necesidades. Gracias a las alianzas con los mejores partners, MAYA PROFESSIONAL TOOLS ofrece un amplio rango de productos de primera calidad.

Each industry has a cleaning solution. Thanks to the partnership with the best companies in the cleaning sector, MAYA PROFESSIONAL TOOLS offers a first quality product range.



Escobas y cepillos
Brooms and brushware

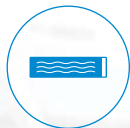

Sistema Greenspeed
Greenspeed System



Palos
Handles



Limpieza de cristales
Window cleaning



Cubos y recogedores
Buckets and dustpans



Higiene alimentaria
Food industry cleaning



Fregonas y bayetas
Mops and cloths



Abrasivos
Pads



Mopos
Mops



Gama de productos antiestáticos
Anti-static product range



Carros de limpieza
Cleaning trolleys



Cúters cerámicos
Ceramic blade cutters



Contenedores y papeleras
Containers and waste bins



Índice

Index

06 Escobas y cepillos

Brooms and brushware

Escobas y cepillos · Brooms and brushes
Moqueta y exteriores · Carpets and exteriors
Cepillos especiales · Special brushes



18 Palos

Handles

Palos plastificados · Plastic coated handles
Palos pintados y cromados · Painted and chromed handles
Palos de aluminio · Aluminum handles
Palos extensibles · Telescopic handles



28 Cubos y recogedores

Buckets and dustpans

Cubos · Buckets
Recogedores · Dustpans



36 Fregonas y bayetas

Mops and cloths

Fregonas de algodón · Cotton mops
Fregonas de microfibra · Microfiber mops
Bayetas · Cloths
Esponja EVO · EVO sponge
Bobinas de bayeta · Cloth rolls



48 Mopas

Mops

Mopas y bases metálicas · Flat mops and metal frames
Base + mopa microfibra · Mop frame + microfiber refill
Bases plásticas SPL y mopa microfibra · Plastic mop frames and microfiber mops



54 Carros de limpieza Cleaning trolleys

Carros · Cleaning trolleys
Accesorios carros · Spare Parts



72 Contenedores y papeleras Containers and waste bins

Contenedores de 2 ruedas · 2 wheels containers
Accesorios contenedores 2 ruedas · 2 wheeled container accesories
Contenedores de 4 ruedas · 4 wheels containers
Accesorios contenedores 4 ruedas · 4 wheeled container accesories
Contenedores gran volúmen · High volume containers
Papeleras y contenedores especiales · Waste bins and special containers



92 Sistema Greenspeed Greenspeed System



102 Limpieza de cristales Window cleaning

Limpieza de cristales basic · Basic window cleaning
Limpieza de cristales profesional · Professional window cleaning
Gama Pro+ · Pro+ Line
Sistema inox clásico sin clips laterales · Clipless classic inox system
Sistema latón con clips laterales · Brass system with side clips
Barras "T" · "T" bars
Recambio gomas Ettore · Ettore replacement rubber
Backflip
Rascadores · Scrapers
Vellones · Gloves
Accesorios · Accessories
Cubos · Buckets
Palos extensibles R-E-A-C-H · Exrensible poles R-E-A-C-H
Adaptadores y plumeros · Adaptors and dusters
Haraganes · Squeegees



122 Higiene alimentaria

Food industry cleaning

- Cepillos buque** · Deck scrubs
- Cepillos Suaves PBT** · PBT sweepers
- Cepillos rectos** · Upright brooms
- Cepillo barrenderos PBT** · Medium PBT brooms
- Cepillos barrenderos duros PBT** · PBT Stiff broom
- Cepillos Limpiatuberías** · Tube cleaning brushes
- Haraganes** · Squeegees
- Palos** · Handles
- Cepillos de mano** · Hand brushes
- Espátulas** · Spatulas
- Cucharas de mano** · Hand scoops
- Recogedor** · Dustpan
- Cubos** · Buckets
- Palas** · Shovels
- Productos detectables** · Detectable products
- Colgadores y Railes** · Wall hanging system



162 Abrasivos

Pads

- Discos abrasivos** · Floor pads
- Fibras abrasivas** · Abrasive pads



166 Gama de productos antiestáticos

Anti-static product range

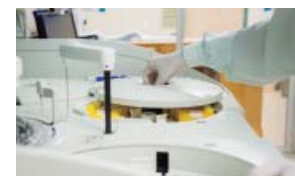

176 Cúters cerámicos

Ceramic blade cutters



ESCOBAS Y CEPILLOS

BROOMS AND BRUSHWARE

PROFESSIONAL SWEEPING

Maya Professional Tools pone a su disposición un amplio rango de escobas y cepillos que se **adaptan a cualquier superficie y a cualquier necesidad de los profesionales de la limpieza.**

Desde la amplia gama de colores que ayuda a diferenciar el barrido en diferentes áreas, hasta la dureza de las fibras que ayuda al barrido en superficies delicadas o más difíciles, **Maya Professional Tools ofrece el mayor abanico de cepillos de la industria para que el profesional pueda elegir.**

Maya Professional Tools provides a big range of brooms and brushes **tailored for each surface and designed to assist the cleaning professionals.**

From a big range of colors which helps to distinguish the sweeping of different areas to the hardness that helps with the task of sweeping different surfaces, Maya Professional Tools offers the **biggest industry range of brooms and brushes to choose the one that best suits the professional cleaners needs.**



Gran variedad de colores

La mejor solución para integrar la limpieza por código de colores.

Big colour range

The best solution to integrate the cleaning colour coding.

Algunas de nuestras escobas se basan en código de colores con el fin de ayudar a identificarlas, definir unas tareas o áreas específicas donde utilizarlas y **conseguir así la mayor higiene y desinfección para su industria.**

La integración de nuestros productos con código de color en su programa de limpieza tiene múltiples ventajas, incluyendo el control de infecciones, la prevención de contaminación cruzada, la diferenciación e identificación entre departamentos o la simplificación del trabajo.

Some of our brooms are colour coded in order to identify different areas or duties to achieve the best cleaning results.

The integration of our colour coding for sweepers in your cleaning duties will give you some advantages: infections prevention and control, cross contamination and the differentiation between areas.



Barrido de exteriores

Ayuda al barrido en las superficies más difíciles.

Exterior Sweeping

Helps to sweep the hardest areas.

La dureza de las fibras de nuestras escobas de exteriores permite una limpieza profunda, especial para el barrido industrial o para barrido exterior tales como suelos rugosos de cemento, piedra, asfalto, etc.

The hardness of the fillaments in our exteriors broom provides a thorough cleaning. This broom is special for external sweeping as rough floors, concrete, stone floors,etc.



Escobas y cepillos

Brooms and brushes



002095



02062



002064



002065



002067

REF	DESCRIP			
002095	ESCOBA ECO ECO BROOM	12/CAJA	UNICO	
02062	ESCOBA AZUCENA AZUCENA BROOM	12/CAJA	UNICO	
002064	ESCOBA CAMELIA CAMELIA BROOM	12/CAJA	UNICO	
002065	ESCOBA CELINDA CELINDA BROOM	12/CAJA	UNICO	
002067	ESCOBA LIS LIS BROOM	12/CAJA	UNICO	



002061

ESCOBA AMAPOLA

AMAPOLA BROOM



12/CAJA



N/A



UNICO



● ●

Escoba Amapola

Funcionalidad, resistencia y buena presencia en un mismo producto.

Amapola Broom

Functionality, resistance and good looking in the same product.

Con la combinación perfecta de materiales hemos conseguido una escoba todo terreno y eficaz a su vez en todo tipo de tareas y superficies, ya sean interiores o exteriores. La escoba multiusos es ideal para tareas profesionales gracias a su tamaño y resistencia.

With a perfect combination of materials Maya has achieved a multipurpose and efficient broom. No matter the surface, interior or exterior. The Amapola broom is the ideal choice for professionals due to its size and resistance.



002066



002068



002070



002008



02044



02010

REF	DESCRIP			
002066	ESCOBA CARLINA CARLINA BROOM	12/CAJA	UNICO	
002068	ESCOBA M-10 M-10 BROOM	12/CAJA	UNICO	
002070	ESCOBA JAZMIN JAZMIN BROOM	12/CAJA	UNICO	
002008	ESCOBA COLORS COLORS BROOM	12/CAJA	UNICO	
02044	ESCOBA TOSCANA TOSCANA BROOM	12/CAJA	UNICO	
02010	ESCOBA CACHÉ CACHÉ BROOM	12/CAJA	UNICO	



02119

ESCOBA JAZMÍN CON PALO 1,30 M

JAZMÍN BROOM WITH HANDLE 1,30 M

12/CAJA
+BOLSA

N/A



UNICO



● ●



002012

ESCOBA PIVOT LUX

PIVOT LUX BROOM



12/CAJA



N/A



UNICO



● ●

Protección anti golpes

Esquinas redondeadas y cubiertas de goma para proteger los rincones más delicados.

Protection against bumps

Rounded corners with rubber to protect the most delicate spaces.

Moquetas y exteriores

Carpets and exteriors



02071



02014



02106



02017



02078



02029

REF	DESCRIP		
02071	ESCOBA JAZMIN MOQUETA JAZMIN CARPET BROOM	12/CAJA	UNICO
02014	ESCOBA TOSCANA MOQUETA TOSCANA CARPET BROOM	12/CAJA	UNICO
002106	ESCOBA JAZMÍN EXTERIORES EXTERIOR JAZMIN BROOM	6/CAJA	UNICO
02017	ESCOBA CORNER MAXI MAXI CORNER BROOM	24/CAJA	UNICO
02078	ESCOBA MIMOSA MIMOSA BROOM	12/CAJA	UNICO
02029	ESCOBA DE GOMA RUBBER BROOM	12/CAJA	UNICO







02045



02047



02046



02048



06022

REF	DESCRIP			
02045	CEPILLO BARRENDERO SUAVE CON HARAGAN SOFT PUSH BROOM	12/CAJA	46 CM	UNICO
02047	CEPILLO BARRENDERO DURO CON HARAGAN HARD PUSH BROOM	9/CAJA	46 CM	UNICO
02046	CEPILLO BARRENDERO SUAVE CON HARAGÁN SOFT PUSH BROOM WITH SQUEEGEE	12/CAJA	60 CM	UNICO
02048	CEPILLO BARRENDERO DURO CON HARAGÁN HARD PUSH BROOM WITH SQUEEGEE	9/CAJA	60 CM	UNICO
06022	PALO CEPILLO BARRENDERO PUSH BROOM HANDLE	12/CAJA	1,40 M.	UNICO

Cepillos especiales

Special brushes



02090

CEPILLO BUQUE ECO

ECO DECK SCRUB



12/CAJA



N/A



UNICO



N/A



02117

CEPILLO ROPA

CLOTHS BRUSH



12/CAJA



N/A



UNICO



N/A



02116

CEPILLO CALZADO

SHOES BRUSH



12/CAJA



N/A



UNICO



N/A



02118

CEPILLO BETUNERO

SHOES POLISH BRUSH



12/CAJA



N/A



UNICO



N/A



02092

CEPILLO MULTIUSOS CON ASA

MULTIPURPOSE BRUSH



12/CAJA



N/A



UNICO



N/A



02089

CEPILLO TECHOS

DUSTER BRUSH



12/CAJA



N/A



UNICO



N/A



02018Z

CEPILLO TECHOS CON PALO EXTENSIBLE

DUSTER BRUSH WITH TELESCOPIC HANDLE



02100

CEPILLO PANADERO LUX

BANISTER BRUSH



02120

ESCOBILLA W.C.ECO

W.C. BRUSH



02086

ESCOBILLA W.C.

W.C. BRUSH



002093

ESCOBILLERO ECO

ECO TOILET BRUSH



Con goma antideslizante
Non-Slipping base



02027

ESCOBILLERO LUX

LUXURY TOILET BRUSH



PALOS HANDLES

NEW ERGO PRO HANDLE

El nuevo palo ergonómico ERGO PRO es el resultado de meses de inversión en I+D con el fin de obtener un producto de superiores prestaciones y que consigue superar a todos sus rivales en el mercado profesional y doméstico por su ergonomía, resistencia y versatilidad.

The new ERGO PRO handle is the result of many months of investment in R&D. The objective is to obtain a high performance product to overcome all its rivals in the professional and household market. Ergonomics, resistance and versatility are the hallmark of ERGO PRO handle.

Ergonomía

Nueva técnica patentada.

Ergonomics

New patented technique.

Mediante una nueva técnica patentada, nuestros ingenieros han sido capaces de inyectar una pieza de goma sobre el tubo y el capuchón del palo que no se mueve, no resbala y ayuda a reducir las tensiones en la muñeca a la hora de escurrir una fregona.

Gracias al diámetro superior que esta goma confiere, las muñecas sufren mucho menos estrés.

Su forma de ondas ergonómicas ayuda a colocar los dedos de la mano en una posición que ayuda a transmitir la fuerza cuando se escurre. Además, la goma en si misma evita que las manos resbalen a la hora de escurrir aunque la superficie del palo esté mojada.



MANETA ERGONÓMICA
ERGONOMIC HANDGRIP

SISTEMA ANTI-LESIONES
INJURIES PREVENTION SYSTEM

Through a new patented technique, our engineers have been able to inject a piece of rubber on the tube and the cap for handgrip to avoid its movement. A non-slip handle that reduces wrist injuries when wringing out the mop.

Thanks to a higher diameter that the rubber confers to the handle wrist suffer less stress.

Its ergonomic undulating shape helps to place the fingers in a position that transfer the power while wringing out the mop. Furthermore, the rubber avoids hand slipping when wringing out the mop even when the handle is wet.

Resistencia

Más resistente que la media de palos que encontrará en el mercado de la higiene.

Resistance

More resistant than the average handle thickness in the market.

El tubo empleado para la fabricación de este palo es de un espesor de 0,36mm, lo que significa que es un 20%-25% más resistente que la media de palos que encontrará en el mercado de la higiene. El tubo está realizado en forma octogonal, de manera que la resistencia a la rotura se aumenta considerablemente.

Nuestra pintura especial GRAFITO, inimitable por nuestros competidores le confiere una protección especial al palo haciéndolo más resistente a la corrosión.

The tube used for the production of the handle is 0,36mm in thickness. It means that the handle is 20 to 25% more resistant than the average handle thickness in the market. The tube is produced with an octagonal shape, making a higher strength resistance.

Our GRAFITO special painting powder, inimitable by our competitors, helps to protect the handle making it more corrosion resistant.

Codificación por color

Fabricado en diferentes colores.

Colour coding

Made with different rubber colors.

El palo ergonómico Ergo Pro se realiza en colores diferentes de goma para poder identificar las diferentes zonas conforme al APPCC. Mediante esta diferenciación, su empresa podrá identificar las diferentes zonas de uso de utensilios de limpieza.

The ergonomic handle Ergo Pro is made with different rubber colors to identify different areas according to HACCP process.



Universalidad

Gracias a una rosca completamente universal.

Universality

Thanks to a universal thread.

Todos nuestros palos van equipados con una rosca completamente universal que le permitirá usar el palo Ergo Pro tanto en Fregonas y escobas como en mopas y otros útiles de limpieza gracias a sus dos pasos de rosca y agujero integrado.

All our handles are made with a universal thread allowing to use Ergo Pro handle with mops, wet mops, brooms and other cleaning tools.

Palos plastificados

Plastic coated handles



006002



06031



006035



006010

REF	DESCRIP				
006002	PALO PLASTIFICADO 1,40 M. PLASTIC COATED METAL HANDLE 1,40M.	12/BOLSA	0,25mm.	UNICO	
06031	PALO PLASTIFICADO 1,20 M. PLASTIC COATED METAL HANDLE 1,20M.	12/BOLSA	0,20mm.	UNICO	
006035	PALO PLASTIFICADO 1,40 M. BRILLANTE PLASTIC COATED SHINY METAL HANDLE 1,40M.	12/BOLSA	0,28mm.	UNICO	
006010	PALO SLALOM DECORADO 1,40 M. SLALOM SHINY PLASTIC COATED HANDLE 1,40M.	12/BOLSA	0,28mm.	UNICO	

Palos pintados y cromados

Painted and chromed handles



06003



06004



06009



06005

REF	DESCRIP				
06003	PALO PINTADO 1,40 M. ESTÁNDAR 4 COLORES STANDARD PAINTED HANDLE 1,40M.	12/BOLSA	0,28mm.	UNICO	
06004	PALO PINTADO TITANIO 1,40 M TITANIUM PAINTED HANDLE 1,40 M	12/BOLSA	0,25mm.	UNICO	
06009	PALO PINTADO ALUFASS 1,40 M. ALUFASS PAINTED HANDLE 1,40M.	12/BOLSA	0,34mm.	UNICO	
06005	PALO ALU-PRO 1,40M. COLORES HACCP ALU-PRO PAINTED HANLDE 1,40M. HACCP	12/BOLSA	0,32mm.	UNICO	

Palos pintados y cromados

Painted and chromed handles



06043

PALO PINTADO ALU-PRO 1,40 M. DIÁMETRO PROFESIONAL

ALU-PRO PAINTED HANDLE 1,40M.





 12/BOLSA  0,32mm.
 UNICO  OCTAGONAL



06019

PALO PINTADO ALU-PRO 1,50 M. DIÁMETRO PROFESIONAL

ALU-PRO PAINTED HANDLE 1,50M.

 12/BOLSA  0,32mm.
 UNICO  OCTAGONAL

Palo Ergonómico ERGO PRO

El más resistente y ergonómico.

NEW

Ergonomic handle ERGO PRO

The most resistant and ergonomic.

En Maya Professional Tools hemos fabricado el palo más resistente y ergonómico que puede encontrar en el mercado gracias a meses de inversión e investigación en I+D por parte de nuestro equipo de ingenieros.

Si sumamos a ello que es un producto resistente y elegante, podríamos decir que está usted ante el mejor utensilio para evitar lesiones y gastos innecesarios ocasionados por roturas. Sus piezas no se mueven ni resbalan y gracias al diámetro y a la formas de sus ondas ergonómicas ayudan a evitar el estrés en muñecas y manos.

Maya Professional Tools has developed the most resistant and ergonomic handle in the market. Work by many people over many months and the investment in R&D has resulted in a special handle. If we add to this, that the product is resistant and elegant we could say that you are facing the best cleaning tool to avoid injuries and cost from breaks.

The pieces on the handle do not move and do not slide, thanks to the diameter and the rubber waves, avoiding overstraining or damage in wrists and hands.



MANETA ERGONÓMICA
ERGONOMIC HANDGRIP

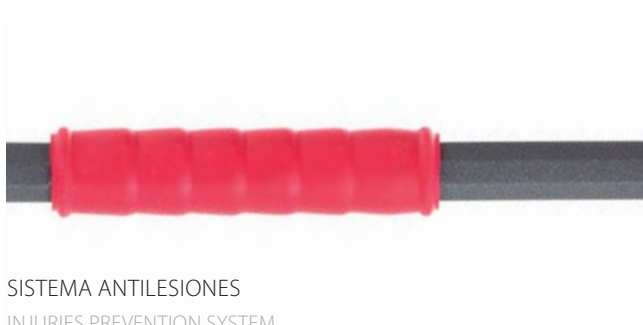

SISTEMA ANTI-LESIONES
INJURIES PREVENTION SYSTEM



06053

Palo Ergo Pro 1,40 M Diametro profesional

ERGO PRO HANDLE 1,40M.



12/CAJA



0,36mm.



UNICO



OCTAGONAL



Rosca doble “Universal”

Para vincular todos tus utensilios de limpieza.

Double “Universal” thread

For linking all your cleaning tools.

Un aspecto fundamental para un palo metálico es la rosca, que permite vincularlo a un utensilio. Si este elemento falla, la combinación del utensilio queda inservible. Nuestra rosca Universal, presente en la mayoría de nuestros palos, le permitirá vincular todos sus utensilios de limpieza de una manera fácil y sin problemas.

A key point for a metal handle is the thread. If this thread fails the use also fails. Our universal thread will allow you to link your cleaning tools easily .



La rosca se compone de 2 diámetros diferentes para permitir la fijación en Escobas y Fregonas de todos los modelos y marcas; además, posee una abertura para poder atravesarla con sistemas de sujeción para Mopas o artículos profesionales (p. ej. pinzas para fregonas profesionales).

The thread is composed by two different diameters, this allows you to link brooms, mops, etc. of all brands and models. Furthermore the thread has two holes for clamping mops or professional cleaning tools.

ANCLAJE MOPA

Agujero para sujeción de mopas y artículos profesionales como por ejemplo Pinzas para fregonas industriales.

MOP CLAMPING

Hole for mop clamping and professional cleaning tools.

ROSCA ESCOBA

Rosca inferior para sujeción a escobas y cepillos de todos los modelos y marcas del mercado.

BROOM THREAD

Lower thread for brooms and brushes.



PUNTOS DE FIJACIÓN

8 puntos de fijación para evitar el problema de muchos otros palos: el desprendimiento de la rosca debido a los movimientos y golpes durante las tareas de limpieza.

FIXING POINTS

8 fixing points for avoiding thread detachment due to impacts or strong movements while cleaning.

ROSCA FREGONA

Diámetro diferenciado para una sujeción mejor en las fregonas de todos los modelos y marcas del mercado.

MOP THREAD

Differentiated diameter for a better clamping.

RELACIÓN ESPESOR / FUERZA DEL TUBO

En este cuadro encontrará una orientación sobre que tipo de espesor elegir para cada tarea de limpieza así como de la resistencia que es necesaria para doblar el tubo de acero de 1m.

THICKNESS VS TUBE STRENGTH

In the table below you'll find an orientation about the correct thickness for each cleaning activity as well as the resistance needed for bending a 1 m steel tube.

TIPOS DE ESPESOR Thickness Type	RESISTENCIA* Resistance*	USO Use
0,23 MM	20,2 kg.	Cepillos de barrer y usos ligeros Brooms for sweeping. Light Use.
0,25 MM	21,9 kg.	Cepillos de barrer y usos con escasa fuerza Brooms for sweeping. Light strength
0,28 MM	24 kg.	Cepillos y fregonas Resistencia estándar Brooms and Mops. Standar resistance.
0,30 MM	25,5 kg.	Cepillos, mopas y fregonas Resistencia media Brooms, Mops and flat mops. Medium resistance.
0,32 MM	26,4 kg.	Cepillos, mopas y fregonas Resistencia media-alta Broom, mops and flat mops. Medium - High resistance.
0,34 MM	28 kg.	Cepillos, mopas y fregonas Resistencia alta Brooms, Mops and Flat Mopr. Very High resistance.

* Fuerza en Kg. necesaria para doblar 1 m. de tubo

* Strengh in Kg needed for bending 1 m tube.

Palos de aluminio

Aluminum handles



06016



06018



06017



006049



06006

REF	DESCRIP				
06016	PALO PLASTIFICADO ALUMINIO 1,40M. ALUMINUM PLASTIC COATED 1,40M.	12/BOLSA	0,55mm	UNICO	
06018	PALO ALUMINIO ANODIZADO 1,50M. ANODIZED ALUMINUM HANDLE 1,50M.	12/BOLSA	0,90mm.	UNICO	
006049	PALO ALUMINIO ESTRIADO 1,40M ANODIZED STRIPPED ALUMINUM HANDLE 1,40M.	12/BOLSA	0,75mm.	UNICO	
06006	PALO ALUMINIO PLASTIFICADO 1,40M. ALUMINUM PLASTIC COATED 1,40M.	UNICO	0,65mm.	UNICO	
06017	PALO ALUMINIO ANODIZADO HACCP 1,40M. ANODIZED ALUMINUM HANDLE 1,40M. HACCP	UNICO	0,90mm.	UNICO	

Palos extensibles

Telescopic handles



06027 06052



06025



06014



06015



15150D



15158

REF	DESCRIP			
06027	PALO EXTENSIBLE 1,5 M ALUMINIO CON ESPONJA ALUMINUM EXTENSIBLE HANDLE 1,5M. WITH SPONGE	10/BOLSA	N/A	UNICO
06052	PALO EXTENSIBLE 3 M ALUMINIO CON ESPONJA ALUMINUM EXTENSIBLE HANDLE 3 M. WITH SPONGE	10/BOLSA	N/A	UNICO
06025	PALO EXTENSIBLE PLASTIFICADO 1,50 M. PLASTIC COATED EXTENSIBLE HANDLE 1,5M.	12/BOLSA	N/A	UNICO
06014	PALO EXTENSIBLE PINTADO 1,5 M. PAINTED EXTENSIBLE HANDLE 1,5M.	12/BOLSA	N/A	UNICO
06015	PALO EXTENSIBLE PINTADO 3 M. PAINTED EXTENSIBLE HANDLE 3M.	12/BOLSA	N/A	UNICO
15150D	COLGADOR PARA PALOS INDIVIDUAL INDIVIDUAL HOLDER FOR HANDLES	12/BOLSA	22-28MM.	UNICO
15158	SET COLGADOR DUPLO HOLDER SET DUPLO	12/BOLSA	22-28MM.	UNICO

CUBOS Y RECOGEDORES
BUCKETS AND DUSTPANS

DESIGNED TO RESIST



Los cubos de Maya Professional Tools son sinónimo de calidad y garantía. Desarrollados con las mejores materias primas del mercado y pensados para resistir las tareas más arduas de la limpieza profesional.

Maya Professional Tools buckets are synonym of quality and guarantee. Developed with the best market raw materials and designed to withstand the biggest challenges.



Un amplio rango de cubos

Distintas opciones para distintas tareas.

A big range of buckets

Different options for different challenges.

Algunas de las características que definen a nuestros cubos son:

- » Asas de metal y doble inyección de goma que ayudan al transporte
- » Apoyo del escurridor sobre el interior del cuerpo del mismo para evitar roturas.
- » Amplio abanico de capacidad en litros para adaptarse a las necesidades de cada profesional.
- » Amplia gama de colores que permite al profesional diferenciar áreas de limpieza.

Some of the characteristics of our buckets are:

- » Metal handle with comfortable injected rubber.
- » Wringer holding system inside the bucket body to avoid wringer breaks.
- » Big range of liters capacity for adapting to each professional needs.
- » Big range of colors, allowing the color coding.



Asas y escurridores funcionales

Sistemas desarrollados para alargar la vida de nuestros productos.

Functional Bucket handles and wringers

Systems developed to extend the lifetime of our products.

Los componentes de los cubos de Maya Professional Tools están diseñados para dar el mejor resultado incluso en las tareas de limpieza más exigentes. Asas ergonómicas que facilitan un agarre fácil y cómodo y escurridores diseñados con apoyos que evitan roturas. Calidad, resistencia y funcionalidad para los profesionales de la limpieza.

Maya Professional Tools bucket components are designed to offer the best result in the most difficult cleaning duties. Ergonomic handles for an easy grip and the wringer holding system that avoids breaks. Quality, resistance, and functionality for the cleaning professionals.

Cubos

Buckets



09000





09001



09069



009034

REF	DESCRIP		
09000	CUBO CON ESCURRIDOR BASIC 10L. BASIC BUCKET WITH WRINGER 10L.	12/BOLSA	UNICO
09001	CUBO CON ESCURRIDOR OVALADO BASIC 12L. BASIC OVAL BUCKET WITH WRINGER 12L.	12/BOLSA	UNICO
09069	CUBO + ESCURRIDOR ECO CON PICO 13 L. ECO BUCKET WITH WRINGER 13 L.	12/BOLSA	UNICO
009034	CUBO MAYA CON ESCURRIDOR 13L. MAYA BUCKET WITH WRINGER 13L.	12/BOLSA	



09037

CUBO CON ESCURRIDOR COLORES 13L.

BUCKET WITH WRINGER COLORS 13L.

- 12/BOLSA
- NO
- UNICO
-



09085

CUBO CON ESCURRIDOR Y ASA METAL 16L.

BUCKET WITH WRINGER AND METAL HANDLE 16L.

- 10/BOLSA
- NO
- UNICO
- N/A



09050

Cubo con escurridor ovalado 15l.

BUCKET WITH WRINGER 15L.



12/BOLSA



NO



UNICO

Más estabilidad

Escurreidor sobre el interior del cuerpo del cubo que le confiere estabilidad (patentado).

More stability

Wringer holding system on the bucket body for more stability.



09082

CUBO CON ESCURRIDOR Y ASA PLÁSTICA 16L.

BUCKET WITH WRINGER AND PLASTIC HANDLE 16L.



12/BOLSA



NO



UNICO



N/A



09030



09047



09029



09002

REF	DESCRIP			
09030	CUBO CON ESCURRIDOR RECTANGULAR 14L. SQUARE BUCKET WITH WRINGER 14L.	12/BOLSA	UNICO	●
09047	Cubo con escurridor ovalado 15 l. basic BUCKET WITH WRINGER 15L. BASIC	12/BOLSA	UNICO	● ● ● ●
09029	CUBO CON ESCURRIDOR OVALADO 14L. OVAL BUCKET WITH WRINGER 14L.	12/BOLSA	UNICO	● ● ● ● ● ● ●
09002	CUBO BASURA BASIC 15 L. CON TAPA BASIC DUST BIN 15L. WITH LID	12/BOLSA	UNICO	

Recogedores

Dustpans



09021



09095



09024



09022



09057



009032



02099

REF	DESCRIP			
09021	RECOGEDOR BASIC CON PALO BASIC DUSTPAN WITH PLASTIC HANDL	24/CAJA	UNICO	
09095	RECOGEDOR CON PALO METÁLICO + GOMA LONG METAL HANDLE DUSTPAN WITH RUBBER	24/CAJA	UNICO	● ● ●
09024	RECOGEDOR CON GOMA + PALO METÁLICO LONG METAL HANDLE COLORS DUSTPAN WITH RUBBER	18/CAJA	UNICO	● ● ● ●
09022	RECOGEDOR PLEGABLE + PALO SWIVEL LONG HANDLE DUSTPAN WITH RUBBER	18/CAJA	UNICO	● ● ●
09057	RECOGEDOR BASCULANTE + PALO FOLDABLE LONG HANDLE DUSTPAN WITH HANDLE	8/CAJA	UNICO	
009032	PALA DE MANO CON GOMA DUSTPAN WITH RUBBER	12/CAJA	UNICO	● ●
02099	CEPILLO CON PALA DE MANO DUSTPAN WITH BRUSH	12/CAJA	UNICO	



09064



09025



33003



33002

Articulación
Fácil plegado

Joint
Easy folding



REF	DESCRIP			
09064	RECOGEDOR GALVANIZADO PINTADO + PALO GALVANIZED AND PAINTED DUSTPAN WITH HANDLE	24/CAJA	UNICO	
09025	RECOGEDOR GALVANIZADO + PALO GALVANIZED DUSTPAN WITH HANDLE	24/CAJA	UNICO	
33003	EXPOSITOR PALA PLEGABLE ALUMINUM SHOVEL DISPLAY	1/BOLSA	UNICO	
33002	PALA PLEGABLE ALUMINIO PINTADA ALUMINUM SHOVEL	1/BOLSA	UNICO	

FREGONAS Y BAYETAS

MOPS AND CLOTHS

YOUR ALLIES AGAINST DIRT

Una vez más Maya Professional Tools consigue que la innovación, la tecnología y la calidad vayan de la mano. La esponja Evo, es un claro ejemplo de que Maya Professional Tools tiene un gran afán por la superación.

Once again Maya Professional Tools brings innovation, technology and quality in one product. The Evo Sponge is a clear example that Maya Professional Tools is a dynamic company with a great desire to improve.



Micromop Pro

Funcionalidad, resistencia e innovación en un mismo producto.

Micromop Pro

Functionality, resistance and innovation in the same product.



Maya Professional Tools vuelve a innovar con la fregona de tiras Micro Mop Pro, una nueva tecnología de microfibras que permite arrastrar la suciedad y el secado en una sola pasada.

Maya Professional Tools has developed a new material on the strips of the Micro Mop Pro. A new microfiber technology that removes dirt and dries in a single pass.



Esponja EVO

Fibras altamente resistentes que no rayan las superficies.

EVO sponge

High resistance fibers that do not scratch surfaces.

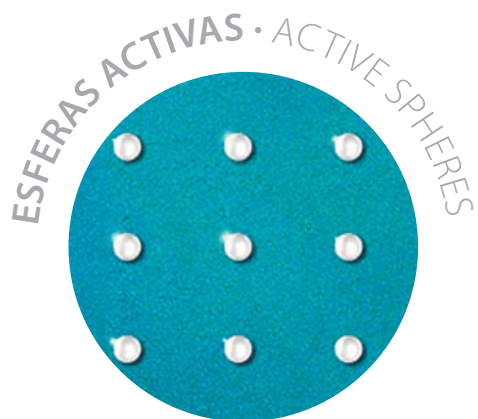

La esponja Evo es una esponja que por sus dimensiones y cualidades técnicas se adapta perfectamente a las necesidades de los profesionales más exigentes.

Due to its sizes and qualities, Evo sponge is a product adaptable to all cleaning professional needs.



Fregonas de algodón

Cotton mops



08006







08007



08009



08055

REF	DESCRIP				
08006	FREGONA ALGODÓN 180G. BLANCO COTTON MOP 180G. WHITE	24/CAJA EXP.	N/A	UNICO	N/A
08007	FREGONA ALGODÓN 190G. BLANCO COTTON MOP 190G. WHITE	24/CAJA EXP.	N/A	UNICO	N/A
08009	FREGONA ALGODÓN 230G. BLANCO COTTON MOP 230G. WHITE	24/CAJA EXP.	N/A	UNICO	N/A
08055	FREGONA ALGODÓN 250G. CRUDO COTTON MOP 250G. NATURAL	24/CAJA EXP.	N/A	UNICO	N/A



08012

FREGONA ALGODÓN INDUSTRIAL 350G. BLANCO

INDUSTRIAL COTTON MOP 350G. WHITE

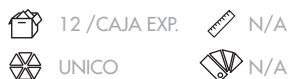

12 /CAJA EXP. N/A

UNICO N/A



08014

PINZA PARA FREGONA INDUSTRIAL HACCP

INDUSTRIAL MOP HOLDER



50/CAJA EXP. N/A

UNICO

Micromop Pro

Tecnología de microfibras.

Micro Mop Pro, una nueva tecnología de microfibras que permite arrastrar la suciedad y el secado en una sola pasada.

Una innovación que aúna en una misma tira poliéster al 100% y una composición compuesta por una mezcla de microfibra en un 80% de poliéster y un 20% de poliamida.

Además de todo lo anterior, durante el proceso de tintado, se generan distintas tonalidades en las diferentes tiras como consecuencia de la diferente composición de materiales de las tiras.

Micromop Pro

Microfiber technologies.

Micro Mop Pro, a new microfiber technology that removes dirt and dries in a single pass.

An innovation that combines in the same strip two different combinations (one side 100% polyester and the other side a combination of 80% polyester and 20% polyamide).

In addition to the above, during the dyeing process, different tones are obtained in each part of the strip due to the different composition of the fibers.



08081

FREGONA MICROMOP PRO

MICROMOP PRO

 25/CAJA EXP.
  N/A

 UNICO



Fregonas de microfibra

Microfiber mops



008049



08086



08110



008050



008051

REF	DESCRIP				
08086	FREGONA MICROFIBRA BLANCA 160 G. MICROFIBER YARN MOP WHITE 160G.	24/CAJA EXP.	N/A	UNICO	
008049	FREGONA MICROFIBRA COLORS 160 G. MICROFIBER YARN MOP COLORS 160G.	24/CAJA EXP.	N/A	UNICO	
08110	FREGONA MICROFIBRA BASIC NEGRA 160 G. MICROFIBER YARN MOP BASIC 160G.	24/CAJA EXP.	N/A	UNICO	
008050	FREGONA MICROFIBRA TIRAS 155 G MICROFIBER STRIPES MOP 155G.	24/CAJA EXP.	N/A	UNICO	
008051	FREGONA MICROFIBRA TIRAS 170 G. MICROFIBER STRIPES MOP 170G.	24/CAJA EXP.	N/A	UNICO	

Bayetas Cloths



07012









07116



07015



07016

REF	DESCRIP				
07012	PACK 5 UDS. BAYETA RAPID PROFESIONAL RAPID CLOTH PACK 5 PCS.	50 X CAJA	40 X 38 CM.	UNICO	
07116	PACK 4 BAYETAS MULTIUSOS IDEA 4 uds. IDEA CLOTH PACK 4 pcs.	12 X 4	40 X 37 CM.	SURTIDO	
07015	PACK 5 UDS. BAYETA MICROPLUS PROFESIONAL MICROPLUS PACK CLOTH 5 PCS.	50/CAJA EXP.	40 X 40 CM.	UNICO	
07016	PACK 5 UDS. BAYETA microblue XXL PROFESIONAL microblue XXL CLOTH PACK 5 PCS	50/CAJA EXP.	40 X 55 CM.	UNICO	



07013



07006



07098



07115



07020



07019

REF	DESCRIP				
07013	PACK 5 UDS. BAYETAS CRISTALES PROFESIONAL GLASS CLOTH PACK 5 PCS.	50 X CAJA	40 X 35 CM	UNICO	
07006	PACK 1 UD. BAYETA CRISTALES EXTRA PERFORADA EXTRA PERFORATED GLASS CLOTH 1 PC	48 CAJA EXP.	38 X 38 CM.	UNICO	
07098	MICROWORKS PACK 1KG. MICROFIBRA PACK 1KG. MICROWORKS MICROFIBER	6 X CAJA		SURTIDO	MULTICOLORES
07115	PACK 12 UDS. BAYETA MICROFIBRA 200G. FAST FAST MICROFIBER CLOTH 200G. PACK 12 PCS.	144 X CAJA	38 X 36 CM.	UNICO	
07020	PACK 5 UDS. BAYETA MICROFIBRA TERRY PROFESIONAL 200G. MICROFIBER TERRY CLOTH 200G. PACK 5 PCS.	50 X CAJA	40 X 40 CM.	UNICO	
07019	PACK 5 UDS. BAYETA MICROFIBRA TERRY PROFESIONAL 300G. MICROFIBER TERRY CLOTH 300G. PACK 5 PCS.	50 X CAJA	40 X 40 CM.	UNICO	



07111



07089



07117



07088



07003



07090

REF	DESCRIP				
07111	BAYETA SUPER MICROFIBRA 350gsm 1 Ud. SUPER MICROFIBER CLOTH 1 Pc.	32/CAJA EXP.	38 X 38CM.	UNICO	
07089	BAYETA MICROFIBRA ESPECIAL MUEBLES 1 Ud. MICROFIBER FURNITURE CLOTH 1 Pc.	20/CAJA EXP.	40 X 40CM.	UNICO	
07117	BAYETA ACTIVE 360 ULTRA 1 Ud. ACTIVE 360 ULTRA CLOTH 1 Pc.	24	37 X 35CM	UNICO	
07088	BAYETA MICROFIBRA ESPECIAL CRISTALES 1 Ud. MICROFIBER GLASS CLOTH 1 Pc.	36 X CAJA EXP	40 X 40 CM	UNICO	
07003	BAYETA MULTIUSOS POSAVAJILLAS 1 Ud. DRAINBOARD CLOTH 1 Pc.	24	45 X 50CM	UNICO	
07090	ESPONJA ACTIVA MULTIUSOS 1 Ud. MULTIPURPOSE ACTIVE SPONGE 1 Pc.	24	19 X 21CM	UNICO	

Esponja EVO

EVO sponge



07063

PACK 4 UDS ESPONJA EVO PROFESIONAL (HACCP)

PROFESSIONAL EVO PAD (HACCP)

8X4 / CAJA

UNICO

13,5 X 9 CM.



Estropajo estándar
Standard scourer



Esponja EVO
EVO sponge

La esponja Evo es una esponja que por sus dimensiones y cualidades técnicas se adapta perfectamente a las necesidades de los profesionales más exigentes. Una esponja que contiene esferas de poliuretano que multiplican la fuerza con el mismo esfuerzo. La esponja Evo sustituye a la esponja abrasiva y elimina 4 veces más la suciedad.

Además:

- » No raya las superficies.
- » No deja Residuos de fibras
- » No retiene la suciedad
- » Lavable en lavadora y autoclave
- » Conforme al APPCC

The Evo Sponge is a clear example that Maya Professional Tools is a dynamic company with a great desire to improve. Evo sponge is a product that for its dimensions and technical qualities can be adapted to the most demanding professionals. A sponge that contains polyurethane spheres inside multiplying power with same effort. Evo sponge replaces abrasive pads and remove dirt without abrasiveness.

Furthermore:

- » Doesn't scratch surfaces
- » No residues left
- » Doesn't retain dirt
- » Washable in washing machine and autoclave
- » According to HACCP code

Esponja VITRO-PAD

VITRO-PAD sponge



07136

ESPONJA VITROPAD ANTI RAYAS

VITROPAD ANTI SCRATCH SPONGE

12/
CAJA EXP.

UNICO

11,5 X 8 CM.

N/A

Bobinas de bayeta

Cloth rolls



07077 · 07109 · 07022 · 07082



07078 · 07099 · 07023 · 07083



07079 · 07059 · 07049

REF	DESCRIP				
07077	BOBINA BAYETA MULTIUSOS CON PRECORTE 2 M. MULTIPURPOSE ROLL WITH PRE-CUT 2 M.	12 / CAJA	2 X 0,38M.	UNICO	●
07109	BOBINA BAYETA MULTIUSOS CON PRECORTE 6 M. MULTIPURPOSE ROLL WITH PRE-CUT 6 M.	12 / CAJA	6 X 0,38M.	UNICO	●
07022	BOBINA BAYETA MULTIUSOS CON PRECORTE 8 M. MULTIPURPOSE ROLL WITH PRE-CUT 8 M.	12 / CAJA	8 X 0,38M.	UNICO	●
07082	BOBINA BAYETA MULTIUSOS CON PRECORTE 14 M. MULTIPURPOSE ROLL WITH PRE-CUT 14 M.	12 / CAJA	14 X 0,38M.	UNICO	●
07078	BOBINA BAYETA EXTRA ABSORBENTE CON PRECORTE 2M. EXTRA ABSORBENT ROLL WITH PRE-CUT 2 M.	12 / CAJA	2 X 0,40M.	UNICO	BLANCO CON CRUCES GRISES
07099	BOBINA BAYETA EXTRA ABSORBENTE CON PRECORTE 6M. EXTRA ABSORBENT ROLL WITH PRE-CUT 6 M.	12 / CAJA	6 X 0,40M.	UNICO	BLANCO CON CRUCES GRISES
07023	BOBINA BAYETA EXTRA ABSORBENTE CON PRECORTE 8M. EXTRA ABSORBENT ROLL WITH PRE-CUT 8 M.	12 / CAJA	8 X 0,40M.	UNICO	BLANCO CON CRUCES GRISES
07083	BOBINA BAYETA EXTRA ABSORBENTE CON PRECORTE 14M. EXTRA ABSORBENT ROLL WITH PRE-CUT 14 M.	6 / CAJA	14 X 0,40M.	UNICO	BLANCO CON CRUCES GRISES
07079	BOBINA BAYETA RAPID CON PRECORTE 2M. RAPID CLOTH ROLL WITH PRE-CUT 2M.	12 / CAJA	2 X 0,32M.	UNICO	●
07059	BOBINA BAYETA RAPID CON PRECORTE 8M. RAPID CLOTH ROLL WITH PRE-CUT 8M.	12 / CAJA	8 X 0,32M.	UNICO	●
07049	BOBINA BAYETA RAPID CON PRECORTE 14M. RAPID CLOTH ROLL WITH PRE-CUT 14M.	6 / CAJA	14 X 0,32M.	UNICO	●



REF	DESCRIP				
07080	BOBINA BAYETA POSAVAJILLAS CON PRECORTE 2M. DRAINBOARD CLOTH ROLL WITH PRE-CUT 2M.	12 / CAJA	2 X 0,40M.	UNICO	NARANJA CON CRUCES GRISES
07061	BOBINA BAYETA POSAVAJILLAS CON PRECORTE 8M. DRAINBOARD CLOTH ROLL WITH PRE-CUT 8M.	12 / CAJA	8 X 0,40M.	UNICO	NARANJA CON CRUCES GRISES
07085	BOBINA BAYETA POSAVAJILLAS CON PRECORTE 14M. DRAINBOARD CLOTH ROLL WITH PRE-CUT 14M.	6 / CAJA	14 X 0,40M.	UNICO	NARANJA CON CRUCES GRISES



REF	DESCRIP				
07084	ROLLO BAYETA MICROGLASS CON PRECORTE 6 UDS. MICROGLASS CLOTH ROLL WITH PRE-CUT 6PCS.	20 / CAJA	3,6 X 0,40M.	UNICO	●
07075	ROLLO BAYETA MICROGLASS CON PRECORTE 12 UDS. MICROGLASS CLOTH ROLL WITH PRE-CUT 12PCS.	12 / CAJA	3,6 X 0,40M.	UNICO	●



07076

ROLLO BAYETA MICROFOOD 500 SERVICIOS CON PRECORTE

MICROFOOD CLOTH ROLL WITH PRE-CUT 500 SERVICES

 1/BOLSA 33 X 33 CM UNICO N/A

Bayetas Desechables

Disposable Cloths



07135



07129



07131



07130

REF	DESCRIP				
07135	ROLLO BAYETA DESECHABLE 500 SERVICIOS 45 G/M2 DISPOSABLE CLOTH ROLL	2 X CAJA	33 X 33 CM.	UNICO	●
07129	ROLLO BAYETA DESECHABLE 500 SERVICIOS 70G/M2 DISPOSABLE CLOTH ROLL	12 X 4	33 X 33 CM.	UNICO	●
07131	PACK 50 BAYETAS DESECHABLES ANTIBACTERIAS 80G/M2 DISPOSABLE ANTIBACTERIAL CLOTH	20	35 X 38 CM.	UNICO	● ● ● ● ●
07130	PACK 100 RECAMBIOS MOPA CON ACEITE MINERAL 38 G/M2 MOP COVER WITH DUST CATCHER OIL	8	60 X 30 CM.	UNICO	●

MOPAS
MOPS

A MUST IN THE PROFESSIONAL CLEANING



Funcionalidad Combi

Doble uso, doble rendimiento.

El soporte con bastidor giratorio permite su utilización en la limpieza de todo tipo de superficies (suelos, paredes, zócalos, escaleras, etc.).

La mopa klick combi permite hacer una limpieza en seco y en húmedo adaptándose a las necesidades del profesional.

Combi functionality

Double use, double efficiency.

The klick combi swivel frame allows to use it in all surfaces (floors, walls, baseboards, stairs, etc.)

Klick Combi mop is a multifunctional mop that can be used for wet and dry cleaning adapting to the cleaning professionals needs.

Soporte con bastidor giratorio

Utilización en la limpieza de todo tipo de superficies.

La mopa Klick Combi cumple con todos los requisitos para ser un imprescindible en cualquier tarea de fregado profesional donde la fregona convencional no llega. Una de las ventajas que ofrece este producto es que puede ser utilizada para la limpieza en húmedo o en seco (posibilidad de utilizar en seco para la limpieza previa antes del proceso en mojado, atrayendo el polvo).

Recambios fácilmente intercambiables.

Swivel Frame

Allows to use it in all surfaces.

The Klick Combi mop satisfies all the criteria for being an essential at any cleaning activity where the traditional mop isn't efficient enough. One of the advantages of this mop is that can be used for wet and dry cleaning.



Refills can be changed easily and fast.





Mopas y bases metálicas

Flat mops and metal frames









REF	DESCRIP			
08015	BASTIDOR METÁLICO 45 CM METAL MOP FRAME 45 CM	20 / CAJA	45CM	UNICO
08054	BASTIDOR METÁLICO 60 CM METAL MOP FRAME 60 CM	20 / CAJA	60CM	UNICO
08016	BASTIDOR METÁLICO 75 CM METAL MOP FRAME 75 CM	20 / CAJA	75CM	UNICO
08017	BASTIDOR METÁLICO 100 CM METAL MOP FRAME 100 CM	20 / CAJA	100CM	UNICO
08059	BASTIDOR METÁLICO 140 CM METAL MOP FRAME 140 CM	20 / CAJA	140CM	UNICO



REF	DESCRIP			
08027	RECAMBIO ALGODÓN MOPA 45 CM COTTON FLAT MOP REFILL 45 CM	24 / CAJA	45CM	UNICO
08053	RECAMBIO ALGODÓN MOPA 60 CM COTTON FLAT MOP REFILL 60 CM	18 / CAJA	60CM	UNICO
08029	RECAMBIO ALGODÓN MOPA 75 CM COTTON FLAT MOP REFILL 75 CM	14 / CAJA	75CM	UNICO
08030	RECAMBIO ALGODÓN MOPA 100 CM COTTON FLAT MOP REFILL 100 CM	12 / CAJA	100CM	UNICO
08058	RECAMBIO ALGODÓN MOPA 140 CM COTTON FLAT MOP REFILL 140 CM	6 / CAJA	140CM	UNICO



REF	DESCRIP				
08075	RECAMBIO MICROFIBRA MOPA 45 CM MICROFIBER FLAT MOP REFILL 45 CM	12 / CAJA	45CM	UNICO	
08076	RECAMBIO MICROFIBRA MOPA 60 CM MICROFIBER FLAT MOP REFILL 60 CM	12 / CAJA	60CM	UNICO	
08077	RECAMBIO MICROFIBRA MOPA 75 CM MICROFIBER FLAT MOP REFILL 75 CM	12 / CAJA	75CM	UNICO	

Base + mopa microfibra

Mop frame + microfiber refill



08028

MOPA MICROFIBRA CON RECAMBIO 40CM

MICROFIBER MOP WITH PLASTIC BASE 40CM

 12 / CAJA 40 x 14,5CM. UNICO AZUL MAYA

08107

RECAMBIO MOPA MICROFIBRA 40CM

MICROFIBER MOP REFILL 40 CM

 24 / CAJA 40 x 14,5CM. UNICO BLANCO

Limpieza en seco

Deja tus suelos relucientes. Nuestras mopas permiten una perfecta limpieza en seco y sobre cualquier tipo de superficie.

Dry clean

Your floor clean and shiny. Our mops help you with a dry cleaning in any kind of floor.

Fácil montaje

La mopa se pliega en un click para hacer más fácil y sencilla la tarea de sustituir los recambios una vez utilizados.



Easy assembling

Easy mop folding to make your refills replacement easier.





Bases plásticas SPL y mopas microfibra

Plastic mop frames and microfiber mops





REF	DESCRIP		
08018	BASE MOPA PLÁSTICO SPL 40 CM PLASTIC MOP FRAME SPL 40 CM	10 / CAJA	UNICO
08019	BASE MOPA PLÁSTICO SPL 50 CM PLASTIC MOP FRAME SPL 50 CM	10 / CAJA	UNICO







REF	DESCRIP			
08035	MOPA CON BOLSILLOS MICROFIBRA 40 CM POCKET MICROFIBER FLAT MOP 40CM.	12 / CAJA	UNICO	
08036	MOPA CON BOLSILLOS MICROFIBRA 50 CM POCKET MICROFIBER FLAT MOP 50CM.	12 / CAJA	UNICO	



REF	DESCRIP		
08020	BASE MOPA HÚMEDA PLÁSTICO SPL 40 CM WET CLEANING PLASTIC MOP FRAME SPL 40 CM	10 / CAJA	UNICO
08021	BASE MOPA HÚMEDA PLÁSTICO SPL 50 CM PLASTIC WET MOP FRAME SPL 40 CM	10 / CAJA	UNICO



REF	DESCRIP			
08039	MOPA HÚMEDA CON SOLAPAS MICROFIBRA 40 CM RIBBON MICROFIBER FLAT MOP 40CM.	12 / CAJA	UNICO	
08040	MOPA HÚMEDA CON SOLAPAS MICROFIBRA 50 CM RIBBON MICROFIBER FLAT MOP 50CM.	12 / CAJA	UNICO	



08078
**BASE MOPA KLICK COMBI PARA CUBO PIKO
UNIVERSAL 40 CM**

PLASTIC WET MOP FRAME SPL 50 CM



08079
MOPA PARA BASE KLICK COMBI

RIBBON MICROFIBER FLAT MOP KOMBI 40CM.



CARROS DE LIMPIEZA CLEANING TROLLEYS

CLEANING AND STORAGE SYSTEMS

Nuestros carros han sido diseñados para resistir las condiciones más duras de trabajo. Para ello se han fabricado con los mejores materiales plásticos (con mezclas de polímeros y aditivos especiales) y con las partes metálicas en acero inoxidable AISI 316 barnizado para dar un toque estético.

Se realizan "drop test" lanzando los carros desde una altura equivalente a un 2º piso para observar la resistencia al impacto, con resultados sorprendentes.

Our cleaning trolleys are designed to withstand the hardest working conditions. They have been manufactured with the best plastics (mixtures of polymers and special additives) and metal parts in AISI 316 stainless steel varnished to give an aesthetic touch.

Drop test are made from a height equivalent to a 2nd floor to observe the impact resistance, with surprising results.



Carros multifuncionales

Productos pensados para durar toda una vida.

Multifunctional trolleys

Products designed to last for a lifetime.

Actuando como delegación de la empresa Splast para España y Portugal, ofrecemos la más alta tecnología aplicada a los carros multifuncionales de limpieza.

Ofrecemos a nuestros clientes un grupo de productos ergonómicos y de calidad muy avanzada diseñados para optimizar el proceso de limpieza y transporte de residuos.

As Splast partner for Spain and Portugal, Maya Professional Tools offers the highest technology in the cleaning trolleys.

We offer our clients a range of ergonomic and high quality products designed to optimize the cleaning and residues storage.



1 Acero inoxidable
Tubos de inox para un mejor rendimiento.

Stainless steel.
Stainless tubes for a better resistance.

2 Pictograma residuos
Disponibles diferentes pictogramas según residuos.

Pictogram for waste sorting
Different pictograms available depending on needs.

3 Tapa para bolsa
Cubre los residuos de la vista.

Bag lid
Hides residues form view.

4 Bolsa protectora
Bolsa de tela para una mejor protección.

Covering bag
Textile bag for a better protection.

5 Bolsillos adicionales
Para proporcionar un mejor acceso.

Additional pockets.
For an easy access.

6 Diseño moderno
Con un innovador aspecto más refinado.

Modern design.
With an innovative design.

7 Bandejas deslizantes
Sistema con deslizamiento suave.

Sliding trays or shelves
Near-noiseless sliding

8 Composición modular
Piezas acoplables entre sí y de fácil montaje.

Modular design
Easy assembling

9 Paragolpes
En las 4 esquinas y realizados con materiales elastómeros.

Bumpers
Four corners with elastomeric bumpers.

10 Alta calidad
Fabricados con los mejores materiales.

High quality
Firts quality raw materials.



91116



91125



91115

REF	DESCRIP			
91116	CUBO PIKO + BASE KLIKK COMBI 40cm + RECAMBIO MICROFIBRA PIKO BUCKET + MOP FRAME KLIKK COMBI 40CM + MICROFIBER REFILL	1 /CAJA	N/A	UNICO
91115	CUBO PIKO + BASE KLIKK COMBI 40cm + RECAMBIO MICROFIBRA + PALO EXTENSIBLE PIKO BUCKET + MOP FRAME KLIKK COMBI 40CM + MICROFIBER REFILL + EXTENSIBLE HANDLE	1 /CAJA	N/A	UNICO
91125	CUBO PIKO CON RUEDAS + BASE MOPA KLIKK COMBI 40 CM + RECAMBIO MICROFIBRA WHEELED PIKO BUCKET + MOP FRAME KLIKK COMBI 40CM + MICROFIBER REFILL	1 /CAJA	N/A	UNICO



91002



91126



91127





91128



91129



91130

REF	DESCRIP			
91002	CARRO TSK-0001 TSK-0001 TROLLEY	1 /CAJA	N/A	UNICO
91126	CARRO TSK-0001 TSK-0001 TROLLEY	1 /CAJA	N/A	UNICO
91127	CARRO TSK-0002 TSK-0002 TROLLEY	1 /CAJA	N/A	UNICO
91128	CARRO TSK-0003 TSK-0003 TROLLEY	1 /CAJA	N/A	UNICO
91129	CARRO TSK-0004 TSK-0004 TROLLEY	1 /CAJA	N/A	UNICO
91130	CARRO TSK-0009 TSK-0009 TROLLEY	1 /CAJA	N/A	UNICO



91003



91131



91132



91133



91134



91135

REF	DESCRIP			
91003	CARRO TS-0002 TS-0002 TROLLEY	1 /CAJA	N/A	UNICO
91131	CARRO TSK-0005 TSK-0005 TROLLEY	1 /CAJA	N/A	UNICO
91132	CARRO TSK-0006 TSK-0006 TROLLEY	1 /CAJA	N/A	UNICO
91133	CARRO TSK-0007 TSK-0007 TROLLEY	1 /CAJA	N/A	UNICO
91134	CARRO TSK-0008 TSK-0008 TROLLEY	1 /CAJA	N/A	UNICO
91135	CARRO TSK-0010 TSK-0010 TROLLEY	1 /CAJA	N/A	UNICO



91038



91039



91040



91041



91042



91043

REF	DESCRIP			
91038	CARRO TSS-0001 TSS-0001 TROLLEY	1 /CAJA	N/A	UNICO
91039	CARRO TSS-0002 TSS-0002 TROLLEY	1 /CAJA	N/A	UNICO
91040	CARRO TSS-0003 TSS-0003 TROLLEY	1 /CAJA	N/A	UNICO
91041	CARRO TSS-0004 TSS-0004 TROLLEY	1 /CAJA	N/A	UNICO
91042	CARRO TSS-0005 TSS-0005 TROLLEY	1 /CAJA	N/A	UNICO
91043	CARRO TSS-0006 TSS-0006 TROLLEY	1 /CAJA	N/A	UNICO



91044



91045



91046



91047



91048



91049

REF	DESCRIP			
91044	CARRO TSS-0007 TSS-0007 TROLLEY	1 /CAJA	N/A	UNICO
91045	CARRO TSS-0008 TSS-0008 TROLLEY	1 /CAJA	N/A	UNICO
91046	CARRO TSS-0009 TSS-0009 TROLLEY	1 /CAJA	N/A	UNICO
91047	CARRO TSS-0010 TSS-0010 TROLLEY	1 /CAJA	N/A	UNICO
91048	CARRO TS-0025 TSS-0005 TROLLEY	1 /CAJA	N/A	UNICO
91049	CARRO TSZ-0001 TSZ-0001 TROLLEY	1 /CAJA	N/A	UNICO



91050



91051



91052



91053



91054



91055

REF	DESCRIP			
91050	CARRO TSZ-0002 TSZ-0002 TROLLEY	1 /CAJA	N/A	UNICO
91051	CARRO TSZ-0003 TSZ-0003 TROLLEY	1 /CAJA	N/A	UNICO
91052	CARRO TSZ-0004 TSS-0004 TROLLEY	1 /CAJA	N/A	UNICO
91053	CARRO TSZ-0005 TSZ-0005 TROLLEY	1 /CAJA	N/A	UNICO
91054	CARRO TSZ-0006 TSZ-0006 TROLLEY	1 /CAJA	N/A	UNICO
91055	CARRO TSZ-0007 TSZ-0007 TROLLEY	1 /CAJA	N/A	UNICO



91056



91057



91058



91059



91060



91061

REF	DESCRIP				
91056	CARRO TSZ-0008 TSZ-0008 TROLLEY	1 /CAJA	N/A	UNICO	N/A
91057	CARRO TSZ-0009 TSZ-0009 TROLLEY	1 /CAJA	N/A	UNICO	N/A
91058	CARRO TSZ-0010 TSZ-0010 TROLLEY	1 /CAJA	N/A	UNICO	N/A
91059	CARRO TSZ-0011 TSZ-0011 TROLLEY	1 /CAJA	N/A	UNICO	N/A
91060	CARRO TSZ-0012 TSZ-0012 TROLLEY	1 /CAJA	N/A	UNICO	N/A
91061	CARRO TSZ-0013 TSZ-0013 TROLLEY	1 /CAJA	N/A	UNICO	N/A



91062







91063



91064



91065

REF	DESCRIP				
91062	CARRO TSZ-0014 TSZ-0014 TROLLEY	1 /CAJA	N/A	UNICO	N/A
91063	CARRO TSZ-0015 TSZ-0015 TROLLEY	1 /CAJA	N/A	UNICO	N/A
91064	CARRO TSZ-0016 TSZ-0016 TROLLEY	1 /CAJA	N/A	UNICO	N/A
91065	CARRO TSZ-0017 TSZ-0017 TROLLEY	1 /CAJA	N/A	UNICO	N/A



91066



91067



91068



91069

REF	DESCRIP			
91066	CARRO TSZ-0018 TSZ-0018 TROLLEY	1 /CAJA	N/A	UNICO
91067	CARRO TSZ-0019 TSZ-0019 TROLLEY	1 /CAJA	N/A	UNICO
91068	CARRO TSZ-0020 TSZ-0020 TROLLEY	1 /CAJA	N/A	UNICO
91069	CARRO TSZ-0021 TSZ-0021 TROLLEY	1 /CAJA	N/A	UNICO
91070	CARRO TSZ-0022 TSZ-0022 TROLLEY	1 /CAJA	N/A	UNICO

Sistema Modular

Se adapta a tus necesidades.

Modular system

Fitting your needs.

El diseño exclusivo de los productos cumple con los requisitos de las instalaciones con los más altos estándares de calidad estética y funcional.

Nuestro sistema de productos modulares se puede configurar libremente de acuerdo con las necesidades y especificaciones de cada cliente.

The unique design of the product meets the requirements of facilities with the highest standards of aesthetic and functional quality.

Our modular product system can be set freely according to the needs and specifications of each customer.





91071



91094



91095



91096



91097



91203

REF	DESCRIP			
91071	CARRO TSB-0001 TSB-0001 TROLLEY	1 /CAJA	N/A	UNICO
91094	CARRO TSH-0001 TSH-0001 TROLLEY	1 /CAJA	N/A	UNICO
91095	CARRO TSH-0002 TSH-0002 TROLLEY	1 /CAJA	N/A	UNICO
91096	CARRO TSH-0003 TSH-0003 TROLLEY	1 /CAJA	N/A	UNICO
91097	CARRO TSH-0004 TSH-0004 TROLLEY	1 /CAJA	N/A	UNICO
91203	CARRO TSH-0005 TSH-0005 TROLLEY	1 /CAJA	N/A	UNICO



91204



91205



91207



91208



91209



91210



91211



91212

REF	DESCRIP			
91204	CARRO TSH-0006 TSH-0006 TROLLEY	1 /CAJA	N/A	UNICO
91205	CARRO TSH-0007 TSH-0007 TROLLEY	1 /CAJA	N/A	UNICO
91207	CARRO TSH-0008 TSH-0008 TROLLEY	1 /CAJA	N/A	UNICO
91208	CARRO TSH-0009 TSH-0009 TROLLEY	1 /CAJA	N/A	UNICO
91209	CARRO TSH-0010 TSH-0010 TROLLEY	1 /CAJA	N/A	UNICO
91210	CARRO TSH-0011 TSH-0011 TROLLEY	1 /CAJA	N/A	UNICO
91211	CARRO TSH-0012 TSH-0012 TROLLEY	1 /CAJA	N/A	UNICO
91212	CARRO TSH-0013 TSH-0013 TROLLEY	1 /CAJA	N/A	UNICO





91213



91214



91215





91216

REF	DESCRIP			
91213	CARRO TSZZ-0001 TSZZ-0001 TROLLEY	1 /CAJA	N/A	UNICO
91214	CARRO TSZZ-0002 TSZZ-0002 TROLLEY	1 /CAJA	N/A	UNICO
91215	CARRO TSZZ-0003 TSZZ-0003 TROLLEY	1 /CAJA	N/A	UNICO
91216	CARRO TSZZ-0004 TSZZ-0004 TROLLEY	1 /CAJA	N/A	UNICO

Accesorios carros

Trolleys spare parts



REF	DESCRIP		
91027	CUBO 6L. PARA CARROS 6 L. BUCKET FOR TROLLEYS	12 / BOLSA	UNICO
91028	CUBO 25L. PARA CARROS 25 L. BUCKET FOR TROLLEYS	12 / BOLSA	UNICO
91029	CUBO 20L. PARA CARROS 20 L. BUCKET FOR TROLLEYS	12 / BOLSA	UNICO



91033 SEÑAL SUELO MOJADO NARANJA CON MANGO ALUMINIO

WET FLOOR SIGN WITH ALUMINUM HANDLE

	10 / CAJA		N/A
	UNICO		N/A



91032 PRENSA GRIS PARA CARROS





SILVER PRESS FOR TROLLEYS

	1 / CAJA		N/A
	UNICO		N/A



91031 CLICK PARA ENGANCHE PALOS

HOLDING CLICK FOR HANDLES

	1 / BOLSA		N/A
	UNICO		N/A



91119 CESTA PLÁSTICA PARA CARROS CON ASA

PLASTIC BASKET WITH HANDLE FOR TROLLEYS

	1 / BOLSA		N/A
	UNICO		N/A



91117



91118



91120

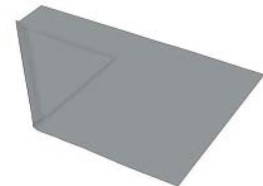

91122



91121

REF	DESCRIP			
91117	SOPORTE BASE PARA BARRA DE CARROS TS-0001 Y TS-0002 BASKET FRAME FOR TROLLEYS TS-0001 AND TS-0002	1 /CAJA	N/A	UNICO
91118	BANDEJA BASE PARA SOPORTE 91117 (FONDO) BASE TRAY FOR BASKET FRAME 91117 (BOTTOM)	1 /CAJA	N/A	UNICO
91120	SOPORTE SUJETA- BOLSAS DE RESIDUOS BASKET FRAME FOR WASTE BAGS TS-0001 AND TS-0002	1 /CAJA	N/A	UNICO
91121	TAPA PARA SOPORTE SUJETA BOLSAS RESÍDUOS LID FOR WASTE BAGS FRAME 91120	1 /CAJA	N/A	UNICO
91122	BOLSA RESÍDUOS 60 LITROS PARA CARROS TS-0001 Y TS-0002 WASTE PLASTIC BAG 60L. FOR TROLLEYS TS-0001 AND TS-0002	1 /CAJA	N/A	UNICO

Carros gama basic

Basic trolleys



91137



91138



91145



91139



91140



91141

REF	DESCRIP				
91137	CARRO MONOSENDO 25 L CON PRENSA SINGLE BUCKET TROLLEY WITH PRESS 25L ECO	1 /CAJA	N/A	UNICO	● ● ● ●
91138	CARRO 2 X 25 L CON PRENSA DOUBLE BUCKET TROLLEY WITH PRESS 25L ECO	1 /CAJA	N/A	UNICO	
91145	BANDEJA PARA CARRO 2 X 25 L CON PRENSA ECO TRAY FOR TROLLEY 2 X25 L	1	N/A	UNICO	●
91139	CARRO 2 X 15 L CON BANDEJAS Y PRENSA MULTI PURPOSE SERVICE TROLLEY WITH TRAYS AND PRESS 15L	1 /CAJA	N/A	UNICO	
91140	PRENSA PARA CARROS PRESS FOR TROLLEYS ECO	1	N/A	UNICO	●
91141	CARRO MULTIUSOS CON BANDEJA MULTIPURPOSE TROLLEY WITH TRAYS ECO	1 /CAJA	N/A	UNICO	●



91144



91142



91143



91146



91147



91148

REF	DESCRIP				
91144	SACO PARA CARRO 91141 FABRIC BAG FOR TROLLEY	1	N/A	UNICO	●
91142	CARRO DE HOTEL CON RUEDAS HOTEL TROLLEY WITH TRAYS	1 /CAJA	N/A	UNICO	
91143	CARRO FOOD CON BANDEJAS FOOD SERVICE TROLLEY WITH TRAYS	1 /CAJA	N/A	UNICO	
91146	CARRO PORTA ROPA 2 X 70 L SIN SACOS LINEN TROLLEY 2X70 L WITHOUT BAGS	1 /CAJA	N/A	UNICO	
91147	CARRO PORTA ROPA 3 X 70 L SIN SACOS LINEN TROLLEY 3X70 L WITHOUT BAGS	1 /CAJA	N/A	UNICO	
91148	SACO 70 L PARA CARROS PORTA ROPA FABRIC BAG 70 L FOR LINEN TROLLEY	1 /CAJA	N/A	UNICO	● ● ● ●

CONTENEDORES Y PAPELERAS

CONTAINERS AND WASTE BINS

QUALITY AND SERVICE AT A GLANCE

Amplia gama de contenedores

Para el reciclaje de todo tipo de residuos.

Desde contenedores de carga trasera de dos y cuatro ruedas, hasta contenedores semi soterrados de 5.000 L. o contenedores para el reciclaje de aceite usado. Sólo dos puntos son denominador común de todos nuestros contenedores: **la calidad y la rapidez en la entrega.**

An extensive range of products

For recycling all types of waste.

From two and four wheels rear loading containers to 5.000 L semi underground containers or recycling used oil containers. Two are the main features: Quality and service.



WEBER

Todos los productos Weber se fabrican según la normativa DIN 30740 / EN 840, haciendo uso de útiles propios, por el proceso de moldeo compacto por inyección en nuestra propia planta ubicada en Haan, cerca de Düsseldorf.

Los contenedores satisfacen los requisitos de la normativa alemana sobre ruido ambiental de acuerdo con la directiva comunitaria pertinente, y llevan la marca correspondiente a su nivel de potencia acústica garantizado (CE).



WEBER

All Weber products are produced on our company premises in Haan, near Düsseldorf off our own tools using the compact injection moulding technique and in compliance with DIN 30740 / EN 840.

The containers comply with the noise protection ordinance according to the EU Directive and bear the guaranteed acoustic power (CE) mark.



Todos los productos son fabricados exclusivamente de material nuevo (mercadería certificada tipo 1a), siendo resistentes a los rayos U.V., al frío, al calor y a los reactivos químicos.

El elevado nivel de calidad de nuestros productos, unas capacidades amplias de producción, nuestros cronogramas exactos de entrega y un servicio confiable: estos son los detalles que constituyen la base de la evolución extraordinariamente positiva de nuestra empresa, y de poder contar con clientes siempre satisfechos.

All products are manufactured exclusively from new basic materials (certified 1a type goods) and are resistant to UV, cold, heat and chemicals.

The high quality standard of our products, our extensive capacities, exact scheduling and reliable service are the basis for the successful development of our company - as well as ensuring satisfied customers.



1 Ruedas rápidas y suaves con bordes de goma sólida. Soft and fast wheels with solid rubber edges

2 Tapas compatibles con contenedores de otras marcas Compatible Lids with other waste bins brands

3 Resistentes a los rayos UV, frío, calor y químicos Resistant to UV, cold, heat and chemicals,

4 Fabricados en PE-HD usando el método de inyección compact Manufactured from high density polyethylene (PE-HD) using compact injection moulding.

Contenedores de 2 ruedas 2 wheels containers

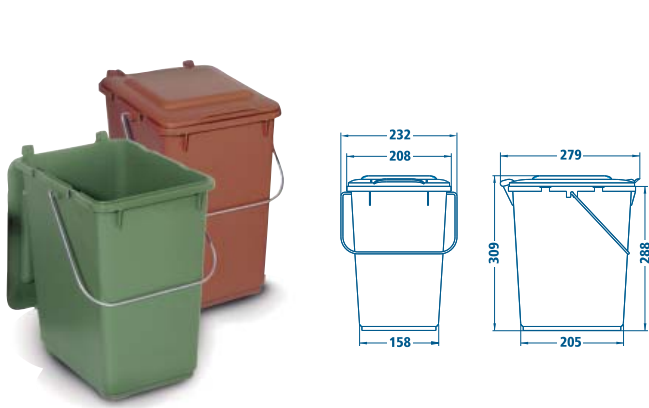

04001

PAPELERA COCINAS 10 L.

ORGANIC WASTE BIN 10 L

- 1 /GRANEL N/A
- ÚNICO ● ●

04002

PAPELERA 50 L. PARA POSTE

50L. WASTE BIN WITHOUT POLE

- 1 /GRANEL N/A
- ÚNICO ●



REF	DESCRIP			
04005	CONTENEDOR 120L. 120L WASTE WHEELED BIN	1 /GRANEL	UNICO	● ● ● ● ● ● ● ● ● ●
04008	CONTENEDOR 180L. 180L WASTE WHEELED BIN	1 /GRANEL	UNICO	●
04007	CONTENEDOR 240L. 240L WASTE WHEELED BIN	1 /GRANEL	UNICO	● ● ● ● ● ● ● ● ● ●
04011	CONTENEDOR 360L. 360L WASTE WHEELED BIN	1 /GRANEL	UNICO	● ● ● ● ● ● ● ● ● ●

Características generales y técnicas de los contenedores de 2 ruedas

Main Technical details of 2 wheels containers

- » Fabricados en **PE-HD** usando el método de inyección compacta.
 - » Producidos sólo con **material virgen**.
 - » Vaciado posible mediante un **sistema de peine elevador estándar**.
 - » Resistentes a los rayos **UV, frío, calor y químicos**.
 - » **Tapas compatibles** con contenedores de otras marcas.
 - » **Ruedas rápidas y suaves** con bordes de goma sólida.
 - » Eje para ruedas realizado en **acero galvanizado**.
 - » Ruedas estándar con bordes de **goma sólida de o 200x50 mm**, con capacidad para **100 Kg/Rueda**.
 - » Los contenedores de **140 L. y 240 L.** pueden ser montados con ruedas de o **250x50 mm**.
 - » **Los contenedores de 360 L.** pueden ser montados con ruedas de o **300x50 mm**.
 - » **Termo impresión, estampado e impresión por pantalla** disponibles.
 - » Diseñados para llevar receptores de datos.
 - » **Los contenedores cumplen con las Directivas relevantes** de protección acústica y van con marcados con el nivel acústico (marca C.E.)
- » Our large refuse containers are manufactured from high density polyethylene (**PE-HD**) using compact injection moulding.
 - » Manufactured from **new basic material**
 - » To be emptied by **tipping over a toothed rim**
 - » Resistant to **UV, cold, heat and chemicals**,
 - » **Compatible lids** with other waste bins brands.
 - » **Smooth-running casters** with solid rubber tyres
 - » Solid steel wheel axle, **galvanised**.
 - » Standard wheels with **solid rubber edges 200x50mm** capacity of **100kg/wheel**.
 - » **140L and 240L** waste bins can be mounted with 250x50 mm wheels.
 - » **360 L waste bins** can be mounted with **300x50 mm** wheels.
 - » **Embossing, hot stamping and screen printing possible**. Prepared to accommodate data carriers
 - » **The containers comply with the noise protection ordinance** according to the EU Directive and bear the guaranteed acoustic power (CE) mark.

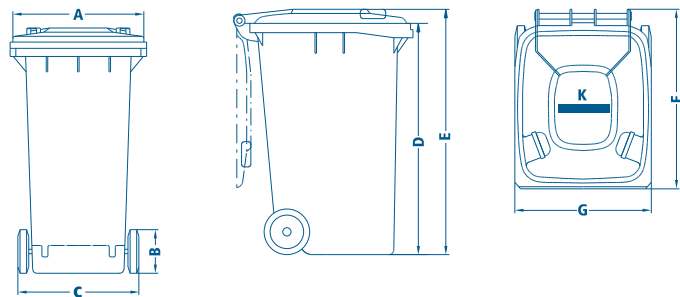



	60 L	80 L	120 L	140 L	240 L	360 L
Volumen nominal (L) Nominal Capacity (L)	60	80	120	140	240	360
Carga nominal (Kg) Nominal Load (kg)	40	40	48	56	96	160
Peso Neto (Kg) Net weight (Kg)	10,7	10	10,4	10,7	14,2	20
A Tapa, ancho (mm) Lid, width (mm)	410	410	442	442	556	583
B Rueda Ø (mm) Wheel Ø (mm)	200	200	200	200/250	200/250	200/250
C Ancho total entre ruedas (mm) Total width between wheels (mm)	449	449	480	480	573	580
D Altura del cuerpo (mm) Body height (mm)	884	880	875	1001	1000	1010
E Altura total (mm) Total Height (mm)	935	935	927	1055	1062	1098
F Profundidad frontal (mm) Depth at front (mm)	516	513	543	544	715	880
G Ancho total (mm) Overall width (mm)	446	445	480	480	577	601
K Campo del cliente 197x30 mm para todos los contenedores de 2 ruedas (nombre del cliente en blanco) Client brand 197x30mm for all two wheels bins (Client name in white).						

Accesorios contenedores 2 ruedas

2 wheels containers accessories



04009 04010 04102

REF	DESCRIP		
04009	PEDAL PARA CUBO 120 L. CON ARO SUJETABOLSAS PEDAL FOR 120L WASTE BIN WITH BAG HOLDER UNMOUNTED	1 /GRANEL	UNICO
04010	PEDAL PARA CUBO 240 L. SIN ARO PEDAL FOR 240 WASTE BIN WITH BAG HOLDER UNMOUNTED	1 /GRANEL	UNICO
04102	PEDAL INOX PARA CUBO 120 L. CON ARO SUJETABOLSAS STAINLESS STEEL PEDAL FOR 120L WASTE BIN WITH BAG HOLDER UNMOUNTED	1 /GRANEL	UNICO



04063

POSTE SUJETA PAPELERAS 50 L.

50L BIN HOLDING POLE

 1 /GRANEL

 ÚNICO



04081

BRIDA SUJETA PAPELERAS

METAL CABLE TIE FOR 50L WASTE BIN HOLDER

 1 /GRANEL

 ÚNICO



REF	DESCRIP	
04110	ANCLAJE SUJETA CONTENEDORES INOX 120/240 L. STAINLESS STEEL HOLDER FOR 120/240L WASTE BINS	1 /GRANEL
04120	ANCLAJE SUJETA CONTENEDORES ZINCADO 120 L./240 L. GLAVANIZED STEEL HOLDER FOR 120/240L WASTE BINS	1 /GRANEL

REF	DESCRIP	
04044	PANTALLA SERIGRAFÍA PRINTING SCREEN	1 /GRANEL
04016	SERIGRAFÍA (COSTE UNITARIO) PRINTING (PRICE PER UNIT)	1 /GRANEL



04017



04067 04085



04018



04019-18 04019-21

REF	DESCRIP			
04017	ABERTURA PARA PAPEL PAPER SLOT	1 /GRANEL	UNICO	
04067	ABERTURA PARA PAPEL CON BUZÓN METÁLICO 120 L. PAPER SLOT WITH METAL COVER FOR 120L BIN	1 /GRANEL	UNICO	●
04085	ABERTURA PARA PAPEL CON BUZÓN METÁLICO 240L. 360 L. PAPER SLOT WITH METAL COVER FOR 240L- 360L BIN	1 /GRANEL	UNICO	●
04018	ABERTURA REDONDA EN TAPA ROUND HOLE ON LID	1 /GRANEL	UNICO	
04019-18	ABERTURA REDONDA EN TAPA CON ROSETA DE GOMA 180MM ROUND HOLE ON LID WITH RUBBER COLLAR 180MM	1 /GRANEL	UNICO	
04019-21	ABERTURA REDONDA EN TAPA CON ROSETA DE GOMA 210MM ROUND HOLE ON LID WITH RUBBER COLLAR 210MM	1 /GRANEL	UNICO	



04020



04021



04066





REF	DESCRIP		
04020	CIERRE CON LLAVE TRIANGULAR (PARCIALMENTE MONTADO) TRIANGULAR LOCK (PARTIALLY MOUNTED)	1 /GRANEL	UNICO
04021	CIERRE GRAVITACIONAL CON LLAVE (PARCIALMENTE MONTADO) GRAVITY LOCK WITH KEY (PARTIALLY MOUNTED)	1 /GRANEL	UNICO
04066	CIERRE ESTÁNDAR CON LLAVE (PARCIALMENTE MONTADO) STANDARD LOCK WITH KEY (PARTIALLY MOUNTED)	1 /GRANEL	UNICO



04022

SISTEMA DE REDUCCIÓN SONORA

NOISE REDUCTION SYSTEM



-  1 /GRANEL
-  N/A
-  ÚNICO
-  N/A



04023

PEGATINAS DE VISIBILIDAD (COSTE UNITARIO)

VISIBILITY STICKERS (PRICE PER UNIT)





-  1 /GRANEL
-  N/A
-  ÚNICO
-  N/A



04086

TAPA SOBRE TAPA DE CAUCHO + AGUJERO REDONDO EN TAPA

RUBBER LID IN LID COVER WITH ROUND HOLE





-  1 /GRANEL
-  N/A
-  ÚNICO
-  N/A



04032

RUEDA CAUCHO 200 MM.

200MM RUBBER WHEEL

-  1 /GRANEL
-  N/A
-  ÚNICO
-  N/A







REF	DESCRIP	
04034	EJE 460 MM PARA CONTENEDORES 120 L. AXEL 460MM FOR 120L BINS	1 /GRANEL
04035	EJE 550 MM PARA CONTENEDORES 240/360 L. AXEL 550MM FOR 240L/360L BINS	1 /GRANEL



04090
PIN PLÁSTICO PARA BISAGRA 60/80/120/240L

PLASTIC PIN FOR HINGE 60/80/120/240L

	1 /GRANEL		N/A
	ÚNICO		N/A



REF	DESCRIP	
04050	CUERPO CONTENEDOR 120 L. 120L WASTE BIN BODY	1 /GRANEL
04052	CUERPO CONTENEDOR 240 L. 240L WASTE BIN BODY	1 /GRANEL
04054	CUERPO CONTENEDOR 360 L. 360L WASTE BIN BODY	1 /GRANEL



REF	DESCRIP	
04053	TAPA CONTENEDOR 240 L. SIN "PINS" 240L WASTE BIN LID WITHOUT PINS	1 /GRANEL
04051	TAPA CONTENEDOR 120 L. SIN "PINS" 120L WASTE BIN LID WITHOUT PINS	1 /GRANEL
04055	TAPA CONTENEDOR 360 L. SIN "PINS" 360L WASTE BIN LID WITHOUT PINS	1 /GRANEL

Contenedores de 4 ruedas

4 wheels containers



04012



04013



04000







04154



04014



04015

REF	DESCRIP			
04012	CONTENEDOR 600L. 600L WASTE BIN WITH WHEELS	1 /GRANEL	UNICO	
04013	CONTENEDOR 800 L. 800L WASTE BIN WITH WEELS	1 /CAJA	UNICO	
04154	CONTENEDOR 1.100 L. TAPA PLANA (MODELO 2015) 1.100L FLAT LID WASTE BIN WITH WHEELS (2015 VERSION)	1 /CAJA	UNICO	
04000	CONTENEDOR 1.100L. TAPA PLANA CON DOBLE TAPA (MODELO 2015) 1.100L FLAT LID IN LID WASTE BIN WITH WHEELS (2015 VERSION)	1 /CAJA	UNICO	
04014	CONTENEDOR 1.100 L. TAPA PLANA 1.100L FLAT LID WASTE BIN WITH WHEELS	1 /CAJA	UNICO	
04015	CONTENEDOR 1.100 L. TAPA CURVA CON DOBLE TAPA 1.100L ROUND LID IN LID WASTE BIN WITH WHEELS	1 /CAJA	UNICO	

Características generales y técnicas de los contenedores de 4 ruedas

Main Technical details of 4 wheels containers

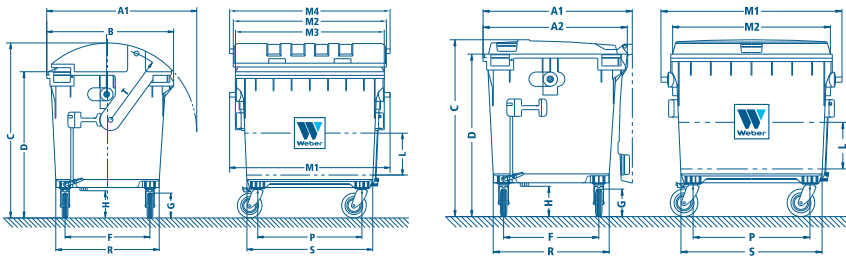



- » Fabricados en **PE-HD** usando el método de inyección compacta.
 - » Producidos sólo con **material virgen**.
 - » Vaciado posible mediante un **sistema de peine elevador estándar**.
 - » Resistentes a los rayos **UV, frío, calor y químicos**.
 - » **Tapas compatibles** con contenedores de otras marcas.
 - » **Ruedas rápidas y suaves** con bordes de goma sólida o 200 mm.
 - » Partes metálicas **galvanizadas**.
 - » **Tapa de fácil apertura** (contenedor 1.100 L tapa basculante) puede fijarse en tres posiciones.
 - » Los contenedores de 1.000 L con tapa basculante, van equipados con **sistema de seguridad para niños** como estándar de acuerdo con la norma EN 840 576 C.
 - » **Termo impresión, estampado e impresión** por pantalla disponibles.
 - » Diseñados para llevar **receptores de datos**.
 - » Los contenedores cumplen con las Directivas relevantes de **protección acústica** y van con marcados con el nivel acústico (marca C.E.)
- » Our large refuse containers are manufactured from high density polyethylene (**PE-HD**) using compact injection moulding.
 - » Manufactured from **new basic material**
 - » To be emptied by **tipping over a toothed rim**
 - » **Resistant to UV, cold, heat and chemicals**, Compatible lids with other waste bins brands.
 - » **Smooth-running** casters with solid rubber tyres
 - » **Solid steel wheel axle**, galvanised.
 - » Easy-to-open flat lid is equipped with three **well-placed opening handles**.
 - » **1.100 L bin** with swing lid have a security system for children (EN840576C)
 - » Embossing, hot stamping and screen printing possible.
 - » The containers comply with the noise **protection ordinance according to the EU** Directive and bear the guaranteed acoustic power (CE) mark.

	600 L	800 L	1100 L	1.100 L.T.C
Volumen nominal (L) Nominal Capacity (L)	660	770	1.100	1.100
Carga nominal (Kg) Nominal Load (kg)	270	310	450	450
Peso Neto (Kg) Net weight (Kg)	45	47	58	68
A1 Profundidad total, tapa abierta (mm) Total depth, open lid (mm)	784	784	1.118	1.210
A2 Cuerpo profundidad total con bisagras (mm) Body total depth with hinges.	770	770	1.082	
B Cuerpo profundidad total (mm) Body total Depth (mm)				1.070
C Altura total (mm) Total Height (mm)	1.215	1.355	1.295	1.465
D Cuerpo, Altura (mm) Body, Height (mm)	1.130	1.275	1.215	1.215
F Ancho total entre ruedas (mm) Total width between wheels. (mm)	481	481	750	750
G Rueda Ø (mm) Wheel Ø (mm)	200	200	200	200
H Distancia al suelo (mm) Ground clearance (mm)	191	191	197	197
M1 Anchura con cañones laterales (mm) Width with trunnions (mm)	1.370	1.370	1.370	1.370
M2 Tapa, ancho (mm) Lid Width (mm)	1.128	1.128	1.167	1.273
M3 Cuerpo, Ancho (mm) Body Width (mm)				1.206
M4 Anchura con cañones en tapa (mm) Width with lid trunnions (mm)				1.370
L Espacio libre hasta asa transporte Free space to the handles	350	350	350	350
P Distancia entre ejes (mm) Distance between centres (mm)	880	880	850	850
R Profundidad, parte inferior (mm) Lower part Depth (mm)	604	608	880	850
S Anchura, parte inferior (mm) Lower part width (mm)	1.062	1.057	1.090	1.090



Accesorios contenedores 4 ruedas

4 wheels containers accessories



REF	DESCRIP		
04030	PEDAL DE APERTURA DESMONTADO 800L DESMONTADO PEDAL FOR 800L WASTE BIN UNMOUNTED	1 /GRANEL	ÚNICO
04191	Pedal de apertura desmontado 600L/Desmontado PEDAL FOR 600L WASTE BIN UNMOUNTED	1 /GRANEL	ÚNICO
04045	PEDAL DE APERTURA DESMONTADO 1.100 L. DESMONTADO GLAVANIZED STEEL HOLDER FOR 120/240L WASTE BINS	1 /GRANEL	ÚNICO



REF	DESCRIP		
04044	PANTALLA SERIGRAFÍA PRINTING SCREEN	1 /GRANEL	ÚNICO
004016	SERIGRAFÍA (COSTE UNITARIO) PRINTING (PRICE PER UNIT)	1 /GRANEL	ÚNICO



04024



04025



04019-24

REF	DESCRIP			
04024	ABERTURA PARA PAPEL PAPER SLOT	1 /GRANEL	ÚNICO	
04025	ABERTURA PARA PAPEL CON BUZÓN DE PLÁSTICO PAPER SLOT WITH PLASTIC COVER	1 /GRANEL	ÚNICO	●
04019-24	2 ABERTURAS REDONDAS EN TAPA CON ROSETA DE GOMA 240MM 2 ROUND HOLES ON LID WITH RUBBER COLLAR 210MM	1 /GRANEL	ÚNICO	



04027



04042





REF	DESCRIP		
04027	CIERRE CON LLAVE TRIANGULAR (PARCIALMENTE MONTADO) TRIANGULAR LOCK (PARTIALLY MOUNTED)	1 /GRANEL	UNICO
04042	CIERRE GRAVITACIONAL CON LLAVE (PARCIALMENTE MONTADO) GRAVITY LOCK WITH KEY (PARTIALLY MOUNTED)	1 /GRANEL	UNICO



04043

SISTEMA DE REDUCCIÓN SONORA 4 RUEDAS

NOISE REDUCTION SYSTEM





 1 /GRANEL  N/A
 ÚNICO  N/A



04086-2

2 TAPAS SOBRE TAPA DE CAUCHO + 2 AGUJEROS REDONDOS EN TAPA

2 RUBBER LID IN LID COVERS WITH ROUND HOLE





 1 /GRANEL  N/A
 ÚNICO  N/A



04023

PEGATINAS DE VISIBILIDAD (COSTE UNITARIO)

VISIBILITY STICKERS (PRICE PER UNIT)

 1 /GRANEL  N/A
 ÚNICO  N/A





04068

SOPORTE METÁLICO CARRETILLA ELEVADORA INOXIDABLE

FORK LIFTER GALVANIZED ADAPTOR FOR 4 WHEELED BINS

 1 /GRANEL  N/A
 ÚNICO  N/A



REF	DESCRIP		
04040	RUEDA CAUCHO 160 MM 160MM RUBBER WHEEL	1 /GRANEL	ÚNICO
04041	RUEDA CAUCHO 160 MM CON FRENO 160MM RUBBER WHEEL WITH BREAK	1 /GRANEL	ÚNICO
04038	RUEDA CAUCHO 200 MM 200MM RUBBER WHEEL	1 /GRANEL	ÚNICO
04039	RUEDA CAUCHO 200 MM CON FRENO 200MM RUBBER WHEEL WITH BREAK	1 /GRANEL	ÚNICO



REF	DESCRIP			
04056	CUERPO CONTENEDOR 660 L 600L BIN BODY	1 /GRANEL	ÚNICO	
04058	CUERPO CONTENEDOR 800 L 800L BIN BODY	1 /GRANEL	ÚNICO	   
04059	CUERPO CONTENEDOR 1.100 L TAPA PLANA 1.100L FLAT LID BIN BODY	1 /GRANEL	ÚNICO	   
04051	CUERPO CONTENEDOR 1.100 L TAPA PLANA (MODELO 2015) 1.100L FLAT LID BIN BODY	1 /GRANEL	ÚNICO	   
04061	CUERPO CONTENEDOR 1.100 L TAPA CURVA 1.100L ROUND LID BIN BODY	1 /GRANEL	ÚNICO	



04057 04060 04152



04062

REF	DESCRIP			
04057	TAPA CONTENEDOR 660 / 800 L. SIN "PINS" 600/800L BIN LID WITHOUT PINS	1 /GRANEL	ÚNICO	
04060	TAPA CONTENEDOR 1.100 L. PLANA SIN "PINS" NI BISAGRAS 1.100L FLAT BIN LID WITHOUT PINS OR HINGES	1 /GRANEL	ÚNICO	
04152	TAPA CONTENEDOR 1.100 L. PLANA SIN "PINS" NI BISAGRAS (MODELO 2015) 1.100L FLAT BIN LID WITHOUT PINS OR HINGES	1 /GRANEL	ÚNICO	
04062	TAPA CONTENEDOR 1.100 L. CURVA COMPLETA 1.100L ROUND BIN LID (COMPLETE)	1 /GRANEL	ÚNICO	



04090



04088



04089

REF	DESCRIP			
04090	PIN PLÁSTICO PARA BISAGRA 660 L./800 L. (1 UNIDAD) PLASTIC PIN FOR 660L./800L LID (1 PC.)	1 /GRANEL	ÚNICO	
04088	BISAGRA CONTENEDOR 1.100 L. TAPA PLANA (1 UNIDAD) PLASTIC HINGE FOR 1.100L FLAT LID (1 PC.)	1 /GRANEL	ÚNICO	
04089	PIN PLÁSTICO PARA BISAGRA 1.100L. (1 UNIDAD) PLASTIC PIN FOR 1.100L LID (1 PC.)	1 /GRANEL	ÚNICO	









04037



04036



04153

REF	DESCRIP			
04037	CAÑÓN LATERAL CONTENEDOR 660/800 L. SIDE TRUNNION FOR 660L/800L	1 /GRANEL	ÚNICO	
04036	CAÑÓN LATERAL CONTENEDOR 1.100 L. SIDE TRUNNION FOR 1.100L	1 /GRANEL	ÚNICO	
04153	CAÑÓN LATERAL CONTENEDOR 1.100 L. (MODELO 2015) SIDE TRUNNION FOR 1.100L (2015 VERSION)	1 /GRANEL	ÚNICO	

Contenedores gran volúmen

High volume containers



04221



04200



04210



04220

REF	DESCRIP			
04221	CAMPANA MINI 1.100 l. POLIETILENO MINI IGLOO 1.100L.	1 /GRANEL	ÚNICO	
04200	CAMPANA 2,5M³ POLIETILENO REDONDA MONTADA FONDO CÓNICO ROUND IGLOO 2,5M³ ROUND AND CONIC BASE	1 /GRANEL	ÚNICO	
04210	CAMPANA 2,5M³ POLIETILENO REDONDA MONTADA 4 ASAS EN FONDO ROUND IGLOO 2,5M³ ROUND BASE	1 /GRANEL	ÚNICO	
04220	CAMPANA 3,2M³ POLIETILENO CUADRADA MONTADA 4 ASAS EN FONDO SQUARE IGLOO 3,2M³ SQUARE BASE	1 /GRANEL	ÚNICO	



04108

CONTENEDOR SEMI SOTERRADO 5M³ POLIÉSTER

SEMI UNDERGROUND CONTAINER 5M³

- 1 /GRANEL N/A
- UNICO MULTICOLOR

Contenedores semi soterrados

Solución para la separación de residuos.

Semi underground containers

Solution for waste separation.

El contenedor soterrado es un método innovador para la recogida de residuos domésticos que se integra perfectamente al paisaje en el cual está introducido. Se puede instalar en cualquier espacio urbano: plazas, calle, patios, hospitales, hoteles, etc. **favoreciendo la recogida selectiva de residuos, eliminando olores y aprovechando al máximo el espacio.**

The underground container is an innovative method for the collection of household waste that is perfectly integrated into the landscape in the qual is introduced . It can be installed in any urban space : squares, streets , playgrounds, hospitals, hotels, etc. **favoring the selective collection of waste, eliminating odors and maximizing space.**

Papeleras y contenedores especiales

Waste bins and special containers



09089



04145



04144



04146



04309

Ruedas traseras que facilitan el transporte.



Rear Wheels for easy transportation.



09003



09004

REF	DESCRIP			
09089	PAPELERA CON PEDAL 30 L. PEDAL BIN 30 L.	1 /BOLSA	ÚNICO	●
04145	PAPELERA CON PEDAL 22L. CON CUBO INTERIOR PEDAL BIN 22L. WITH INTERNAL BUCKET	4 /CAJA	ÚNICO	●
04144	PAPELERA CON PEDAL 50L. CON CUBO INTERIOR PEDAL BIN 50L. WITH INTERNAL BUCKET	2 /CAJA	ÚNICO	○
04146	PAPELERA CON TAPA BASCULANTE 50L. BIN WITH SWIVEL LID 50L.	10 /BOLSA	ÚNICO	○
04309	PAPELERA CON PEDAL Y RUEDAS 70 L. PEDAL BIN WITH WHEELS 70L.	6 /BOLSA	ÚNICO	●●●●●●
09004	CUBO BASURA Y TAPA 50L. RUBBISH BUKET WITH LID 50L.	6 /BOLSA	ÚNICO	●
09003	CUBO BASURA Y TAPA 90L. RUBBISH BUKET WITH LID 90L.	6 /BOLSA	ÚNICO	●

ECOSORT Sistemas de reciclaje

Diseñado para ofrecer una solución flexible y simple para la separación de residuos.

Ecosort Recycling system

Designed to offer a simple and flexible solution for waste separation.



04098

04097

Diseñado para ofrecer una solución flexible y simple para la separación de residuos. Su diseño estrecho y alargado permite aprovechar mejor los espacios limitados. La gama EcoSort® consiste en dos tipos de cuerpo; EcoSort® Mini y EcoSort® Maxi.

Disponibles en ocho tipos de tapas diferentes: Tapa Normal, con abertura para papel, con abertura para envases y botellas, con puertas batientes, vidrio, latas, aluminio, general abierta y con cierre de seguridad para documentos confidenciales.



Las tapas EcoSort® están disponibles en varios colores, permitiendo así una gran variedad de posibilidades de reciclaje.

Designed to offer a unique and flexible solution for waste separation. Designed with a narrow and long body to fit in small spaces. Ecosort bins are produced in two capacities: Ecosort Mini and Ecosort Maxi.

Available in 8 different lids: normal lid, paper opening, packaging and bottles opening, swing lid doors, glass, cans, aluminum, open lid and safety lock lid for confidential documents. Ecosort® lids are available in different colours, making a big range of recycling possibilities possible.



04298

REF	DESCRIP			
04097	CUERPO PAPELERA ECOSORT 60 L. ECOSORT BIN BODY 60L.	6 /BOLSA	ÚNICO	●
04098	CUERPO PAPELERA ECOSORT 87 L. ECOSORT BIN BODY 87L.	6 /BOLSA	ÚNICO	●
04298	BASE CON RUEDAS PAPELERA ECOSORT ECOSORT WHEELED BASE	1 /CAJA	ÚNICO	●



04099

04100

04101

REF	DESCRIP			
04099	TAPAS PAPELERA ECOSORT ESTÁNDAR STANDARD LIDS FOR ECOSORT BINS	4 /CAJA	ÚNICO	● ● ● ● ●
04100	TAPA BATIENTE PAPELERA ECOSORT SWING LID FOR ECOSORT BINS	2 /CAJA	ÚNICO	●
04101	TAPA DE SEGURIDAD DE DOCUMENTOS ECOSORT SAFETY LID WITH KEY FOR ECOSORT BINS	2 /CAJA	ÚNICO	●



04104

04103

Contenedor de pilas



Ideal para lugares de reducido espacio.

Battery Tubes

Ideal for restricted spaces.

Ideal para la recogida de pilas en tiendas y lugares de reducido espacio. Atractivo diseño válido para un amplio rango de posibilidades. Su forma ergonómica facilita el vaciado del contenido. El tubo transparente ayuda a identificar el volumen del llenado del contenedor.

Ideal for pile collecting in shops or other places where there isn't enough space. The ergonomic design its ergonomic design enables the tube to be easily carried and emptied.

REF	DESCRIP			
04104	CONTENEDOR PILAS 5 L. BATTERIES CONTAINER 5 L.	1 /CAJA	ÚNICO	●
04103	CONTENEDOR PILAS 20 L. BATTERIES CONTAINER 20 L.	1 /CAJA	ÚNICO	●



04119

RECOLECTOR DE AGUA 200 L. COMPLETO

WATER COLLECTION SYSTEM 200 L.

**Recolector de agua**

Líder del mercado

Water saving

Market leader

El recolector de agua es un contenedor líder del mercado para la recolección de agua de lluvia en el jardín.

Está compuesto por un captador de agua para canaletas, una base, una tapa con cerradura de seguridad y un grifo.

Our market-leading water butts are suitable for every garden. Supplied with a hose connector. Tap fitting is pre-drilled.



04117



04118

Compostador doméstico



Fabricado con material 100% reciclado

Compost converter

Moulded from 100% recycled material

Nuestro compostador doméstico es fuerte y rígido, es fácil de montar y de usar. La tapa frontal permite el acceso al compostaje final fácilmente. Fabricado a partir de material reciclado 100%. Disponible en dos tamaños: 220 l. y 330 l.

Tough construction. Strong and durable rigid design
Push-fit windproof lid Prevents the contents from blowing.
Moulded from 100% post consumer recycled material

REF	DESCRIP			
04117	COMPOSTADOR DOMÉSTICO 220 L. DOMESTIC COMPOSTER 220L.	1 /BOLSA	ÚNICO	●
04118	COMPOSTADOR DOMÉSTICO 320 L. DOMESTIC COMPOSTER 320L.	1 /BOLSA	ÚNICO	●

SISTEMA GREENSPEED

GREENSPEED

CLEANING THE SMART WAY

Greenspeed

Sistemas de limpieza profesional by MAYA.

Greenspeed es sinónimo de calidad en el sector de la limpieza profesional. Especialista en soluciones de limpieza con productos novedosos y ergonómicos basados en la **tecnología de la microfibra**.

El mayor esfuerzo está puesto en la **sostenibilidad**, conciencia mediambiental, seguridad y limpieza fácil y eficiente.

Greenspeed

Professional cleaning systems by MAYA.

Greenspeed is synonym of quality in the professional cleaning market. Specialists offering innovative cleaning solutions and ergonomic products based on microfiber **technology for the professional cleaning industry**.

Focused on **sustainability**, environmental conciousness, safety and easy and efficient cleaning results..



¿Cómo son Los productos Greenspeed?

Gracias a un proceso de tratamiento único, **la fibra se divide**, de manera que se crea un elaborado **sistema de tubos huecos**. Estos tubos huecos tienen dos ventajas principales:

- 1 Si el producto está húmedo, el agua atrae el polvo y la suciedad en los tubos huecos.
- 2 La capacidad absorbente del producto es muy alta. La etiqueta ecológica (ECOLABEL) significa que los productos cumplen los estrictos **requisitos de medio ambiente, calidad y salud**, esto garantiza, una producción ecológicamente responsable de inicio a fin y la más alta calidad y funcionalidad del producto.

En definitiva:

- » Un medio ambiente limpio,
- » Un resultado de limpieza perfecto y
- » Una durabilidad probada.



How Greenspeed products are?

Thanks to a unique treatment process, **the fibre is splitted**, so that an elaborate **system of hollow tubes** is created. These hollow tubes have two major advantages:

- 1 If the product is wet, the water attracts dust and dirt into the hollow tubes.
- 2 The absorbent capacity of the product is therefore very high. Microfibre products clean effectively, and in many situations, can be used with just clean water, or only a limited use of cleaning agents. **This is a victory won for both health and the environment.**

In Short:

- » Clean environment
- » Perfect cleaning results
- » Proven longevity



Los criterios para la obtención de la etiqueta Ecolabel consideran el ciclo completo de producción, desde la extracción de las materias primas, pasando por la producción, empaquetado, distribución y destrucción de los mismos. **La etiqueta Ecolabel ayuda a los consumidores a identificar fácilmente los productos respetuosos con el medio ambiente.**

Reduce al mínimo el uso de sustancias peligrosas y sustancias que pueden ser perjudiciales para el medio ambiente. El logo ECOLABEL garantiza a los consumidores que el producto tiene un impacto medio ambiental mucho menor en comparación con productos similares del mercado.

Comprando bayetas con el logo ECOLABEL los consumidores se están comprometiendo con el futuro del medio ambiente.

The Nordic Ecolabel means that the products meet the stringent environmental, quality and health requirements of the Nordic Ecolabelling Programme enables.

This guarantees, for example, an ecologically responsible production of cradle-to-grave, the highest product quality and functionality guaranteed in practice. Even the packaging is taken into account, with a low burden on the environment. In short, a clean environment, a perfect cleaning result and a proven longevity.

This protocol ensures that the products continue to be of a high quality.



GS3301011



GS3300611



GS3300705



GS3300456



GS3360405



GS3360600

REF	DESCRIP	
GS3301011	BAYETA MICROFIBRA ORIGINAL GREENSPEED 40 X 40 ORIGINAL GREENSPEED MICROFIBER CLOTH 40 X 40	10 /BOLSA
GS3300611	BAYETA MICROFIBRA BASIC GREENSPEED 40 X 40 BASIC GREENSPEED MICROFIBER CLOTH 40 X 40	10 /BOLSA
GS3300705	BAYETA CRISTALES GREENSPEED 40 X 40 GREENSPEED MICROFIBER GLASS CLOTH 40 X 40	10 /BOLSA
GS3300456	BAYETA DIAMOND GREENSPEED 40 X 40 GREENSPEED MICROFIBER DIAMOND CLOTH 40 X 40	1 /ND
GS3360405	BAYETA ORIGINAL HD MICROFIBRA 62X52 ORIGINAL MICROFIBER HD CLOTH 62 X 52	10 /BOLSA
GS3360600	BAYETA MICROFIBRA DOBLE USO 31 X 31 DOUBLE USE MICROFIBER CLOTH 31 X 31	10 /BOLSA



GS3300430

ESPONJA DIAMOND SPLINKY 9 X 15

GREENSPEED DIAMOND SPLINKY SPONGE 9 X 15



1 /ND



N/A



ÚNICO



N/A



GS3300137

GUANTE MICROFIBRA DOS CARAS GREENSPEED

GREENSPEED MICROFIBER GLOVE



1 /ND



N/A



ÚNICO



N/A

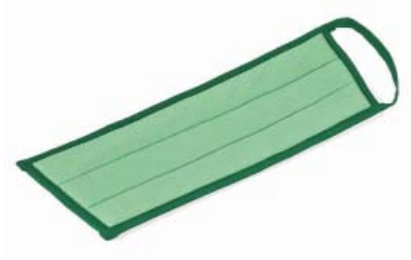

GS3301030

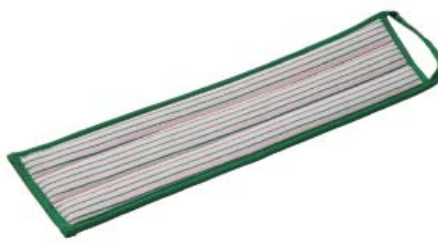

GS3301024



GS3301073 GS3301075



GS3301039 GS3301041



GS3300827 GS3300829



GS3300412

REF	DESCRIP	
GS3301030	GLASS MOP VELCRO 30 CM GREENSPEED GREENSPEED GLASS MOP VELCRO 30 CM	5 /ND
GS3301024	MULTIMOP VELCRO 30 CM GREENSPEED GREENSPEED MULTIMOP VELCRO 30 CM	5 /ND
GS3301073	TWISTMOP VELCRO 45 CM GREENSPEED GREENSPEED TWISTMOP VELCRO 45 CM	5 /ND
GS3301075	TWISTMOP VELCRO 60 CM GREENSPEED GREENSPEED TWISTMOP VELCRO 60 CM	5 /ND
GS3301039	SCRUBMOP VELCRO 45 CM GREENSPEED GREENSPEED SCRUBMOP VELCRO 45 CM	5 /ND
GS3301041	SCRUBMOP VELCRO 60 CM GREENSPEED GREENSPEED SCRUBMOP VELCRO 60 CM	5 /ND
GS3300827	DUSTMOP VELCRO 45 CM GREENSPEED GREENSPEED DUSTMOP VELCRO 45 CM	5 /ND
GS3300829	DUSTMOP VELCRO 60 CM GREENSPEED GREENSPEED DUSTMOP VELCRO 60 CM	5 /ND
GS3300412	DIAMOND MOP 45 CM GREENSPEED GREENSPEED DIAMOND MOP 45 CM	1 /ND

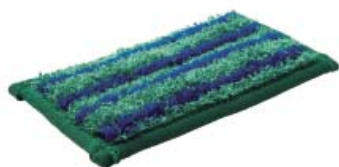

GS3301042



GS3300870

GS3300874

REF	DESCRIP	
GS3301042	MINIPAD 9 X 16 CM FROTAR GREENSPEED MINIPAD SCRUB 9 X 16 CM	1 /ND
GS3300870	RECAMBIO PLUMERO FOX PEQUEÑO MICROFIBRA GREENSPEED FOX DUSTER SMALL MICROFIBER SLEEVE	1 /ND
GS3300874	RECAMBIO PLUMERO FOX MEDIANO MICROFIBRA GREENSPEED FOX DUSTER MEDIUM MICROFIBER SLEEVE	1 /ND



GS3320270



GS3320274



GS3300860



GS3320250

REF	DESCRIP	
GS3320270	SOPORTE FLEXIBLE ATRAPOLVO PEQUEÑO FOX DUSTER SMALL FLEXIBLE HANDLE	1 /ND
GS3320274	SOPORTE FLEXIBLE ATRAPOLVO MEDIANO FOX DUSTER MEDIUM FLEXIBLE HANDLE	1 /ND
GS3300860	RECAMBIO DUSTBOW 8 X 55 CM GREENSPEED DUSTBOW MICROFIBER SLEEVE 8 X 55 CM	1 /ND
GS3320250	MANGO FLEXIBLE PARA DUSTBOW GREENSPEED DUSTBOW FLEXIBLE HANDLE	1 /ND



GS3301406

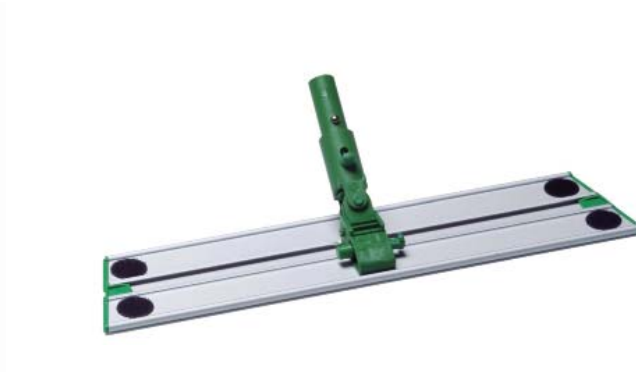

GS3301117



GS3301412 GS3301422



GS3301120 GS3301125

REF	DESCRIP	
GS3301406	BASE MOPA WINGLET MULTIFIX 30CM GREENSPEED FLAT MOP WINGLET MULTIFIX 30 CM	1 /ND
GS3301117	BASE MOPA ALUMINIO MULTILINK 23CM GREENSPEED FLAT ALUMINUM MOP PLATE MILILINK SWIVEL CONNECTOR 23 CM	1 /ND
GS3301412	BASE MOPA WINGLET 40CM ESTÁNDAR GREENSPEED FLAT MOP PLATE WINGLET STANDARD CONNECTION 40 CM	1 /ND
GS3301120	BASE MOPA ALUMINIO 40CM ESTÁNDAR GREENSPEED FLAT ALUMINUM MOP PLATE STANDARD CONNECTION 40 CM	1 /ND
GS3301422	BASE MOPA WINGLET 55CM ESTÁNDAR GREENSPEED FLAT MOP PLATE WINGLET STANDARD CONNECTION 55 CM	1 /ND
GS3301125	BASE MOPA ALUMINIO 55CM ESTÁNDAR GREENSPEED FLAT ALUMINUM MOP PLATE STANDARD CONNECTION 55 CM	1 /ND



GS3301192 GS3301196



GS3210104

GS3210106

REF	DESCRIP	
GS3301192	SOPORTE MANUAL ERGOGRIP PEQUEÑO CON VELCRO HOLDER ERGOGRIP FOR MINIPAD WITH VELCRO	1 /ND
GS3301196	SOPORTE MANUAL ERGOGRIP MEDIANO CON VELCRO HOLDER ERGOGRIP FOR 30 CM MOPS WITH VELCRO	1 /ND
GS3210104	BOTELLA PULVERIZADORA DOBLE ACCIÓN REDONDA GREENSPEED GREENSPEED ROUND SPRAYBOTTLE WITH DOUBLE ACTION	1 /ND
GS3210106	BOTELLA PULVERIZADORA DOBLE ACCIÓN PLANA GREENSPEED GREENSPEED FLAT SPRAYBOTTLE WITH DOUBLE ACTION	1 /ND



GS3311108



GS3330500

REF	DESCRIP	
GS3311108	PALO EXTENSIBLE 2 SECCIONES ERGONÓMICO 1,8M. GREENSPEED GREENSPEED TELESCOPIC HANDLE WITH ERGOBALL 1,8 M.	1 /ND
GS3330500	F.I.T. (FLOORMOP INJECTION TOOL) F.I.T. (FLOORMOP INJECTION TOOL)	1 /ND



F.I.T. Floor Injection Tool

Una metodología totalmente nueva para la limpieza diaria.

La herramienta de Greenspeed® Floormop Injection Tool o FIT, introduce un nuevo método con **mopas de microfibra para la limpieza diaria de los suelos más difíciles.**

La herramienta FIT impregna la mopa con unas boquillas que lanzan el spray. Este sistema tan simple asegura una **limpieza ergonómica y efectiva.** Un diseño contemporáneo y el uso de materiales sintéticos dan al sistema FIT una apariencia profesional.

Además, el sistema FIT evita errores en la limpieza diaria. Gracias a las cuatro posiciones de dosificación las mopas se impregnan de forma precisa. Utilizando FIT serás capaz de **limpiar más metros en menos tiempo.**

F.I.T. Floor Injection Tool

A completely new method for daily cleaning.

The Greenspeed® Floormop Injection Tool or FIT, introduces a completely new method for **daily cleaning of hard floors with a microfibre mop.**

The FIT moistens your flatmop through spray-nozzles. This simple system ensures **effective and ergonomic cleaning.**

A contemporary design and the use of synthetic materials provide the FIT with a professional appearance. Furthermore, the FIT prevents making 'method mistakes'.

Thanks to four dosing positions, the FIT moistens your microfibre mop precisely corresponding with each type of hard floor. This way, you will be able to **clean more square meters in less time.**





Tecnología de microfibras

La limpieza inteligente.

La gama de productos de Greenspeed está pensada para una limpieza rápida y fácil que permite **minimizar el esfuerzo a través de las tecnologías de microfibra más avanzadas.**

Greenspeed garantiza una solución para cada superficie, ofreciendo un concepto de microfibra único gracias al tratamiento de la materia prima que hace que las fibras se abran más que las microfibras tradicionales lo que permite una absorción única e inigualable.

Limpieza de interiores, sanitarios, paredes y suelos... hay una solución para cada necesidad.

Microfiber technology

Cleaning the smart way.

Greenspeed products has been designed for an easy and fast cleaning that allows to **minimize effort through the most innovative microfiber technology.**

Greenspeed has the right solution for each surface, offering a unique microfiber concept. Thanks to a unique treatment process the fiber is splitted up. This results in an elaborate system of hollow tubes, which have a very high absorbing capacity.

Interiors, Sanitary, walls and floors, one solution for each need.

GS3301152

PALO SPRENKLER 1,45 M. GREENSPEED

GREENSPEED SPRENKLER HANDLE 1,45 M.

1 / CAJA

N/A

ÚNICO

N/A



LIMPIEZA DE CRISTALES
WINDOW CLEANING

EFFORTLESS CLEANING

La limpieza de cristales resultará más eficaz y con un acabado profesional gracias a la gama de regletas de goma de Ettore.

Window cleaning will be easier and efficient with a professional finish thanks to Ettore's window cleaning tools.



Ettore, sistema de limpieza de cristales

La solución integral para la limpieza de cristales.

Ettore window cleaning system

The global solution for the window cleaning.

Alto rendimiento para los profesionales más exigentes.
Maya Professional Tools ofrece a través de Ettore, el mejor sistema de limpieza de cristales del mercado.

Maya Professional Tools offers the Ettore window cleaning system.
The best system for window cleaning in the market.

Amplia gama de regletas

Características que lo diferencia del resto:

Big range of channels

Differences with the others:

El secreto del sistema es un borde cuadrado muy afilado, flexible, suave y consistente que deja el vidrio perfectamente limpio y sin restos.

- » Sistema de suspensión patentado y tensión de resorte regulable para presión consistente
- » Alto rendimiento
- » Hoja de goma reemplazable que no deja rayas
- » Las grandes superficies de vidrio se limpian rápidamente con menor número de pasadas.
- » Diseño ergonómico.

The secret of the system is a razor sharp square edge, supple, smooth, consistent which leaves glass perfectly clean and streak free.

- » Patented suspension system and adjustable spring tension for consistent, even pressure
- » High performance
- » Replaceable, streak free rubber blade
- » Large glass surfaces quickly cleaned with fewer passes
- » Ergonomic design



Limpieza de cristales

Window cleaning



17012



55010



17050



60012



63010

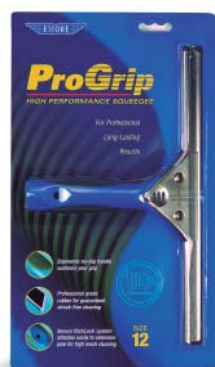

60014

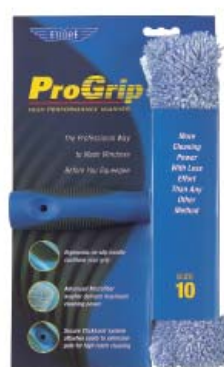

63014



65000

REF	DESCRIP				
17012	LIMPIACRISTALES BÁSICO BASIC SQUEEGEE	CAJA/12	30 CM.	UNICO	N/A
55010	VELLÓN LAVAVIDRIOS BÁSICO BASIC WASHER	CAJA/12	30 CM.	UNICO	N/A
17050	KIT LIMPIEZA LIMPIACRISTALES + VELLÓN + PALO EXTENSIBLE 1,5 m. WINDOW CLEANING KIT WITH EXTENSIBLE HANDLE 1,5M.	CAJA/12	30 CM.	UNICO	N/A
60012	LIMPIACRISTALES PRO PRO SQUEEGEE	CAJA/12	30 CM.	UNICO	N/A
63010	VELLÓN LAVAVIDRIOS PRO PRO WASHER	CAJA/12	30 CM.	UNICO	N/A
60014	LIMPIACRISTALES PRO PRO SQUEEGEE	CAJA/12	35 CM.	UNICO	N/A
63014	VELLÓN LAVAVIDRIOS PRO PRO WASHER	CAJA/12	40 CM.	UNICO	N/A
65000	KIT COMBO PRO GRIP CON LAVAVIDRIOS Y LIMPIACRISTALES KIT COMBO PRO GRIP SQUEEGEE + WASHER	CAJA/10	30 CM.	UNICO	N/A



62010 62014

30500

59017

REF	DESCRIP				
62010	VELLÓN RECAMBIO GLOVE REFILL	CAJA/12	30 CM.	UNICO	N/A
62014	VELLÓN RECAMBIO GLOVE REFILL	CAJA/12	40 CM.	UNICO	N/A
30500	JABÓN PARA LIMPIEZA CRISTALES ESPECÍFICO ETTORE GLASS SOAP	CAJA/6	N/A	UNICO	N/A
59017	LIMPIACRISTALES PARA VEHICULOS CAR WINDOW CLEANER WITH HANDLE	CAJA/12	30 CM.	UNICO	N/A

Limpieza profesional

Professional cleaning



65004



43009 43012

REF	DESCRIP				
65004	PALO FIJO 1,2 M. ALUMINIO CON ENGANCHE RÁPIDO FIXED ALUMINUM HANDLE 1,2 M. QUICK RELEASE	CAJA/6	N/A	UNICO	N/A
43009	PALO EXTENSIBLE 2,4 M. TOTAL EN 3 SECCIONES EXTENSIBLE ALUMINUM HANDLE 2,4M. 3 SECTIONS	CAJA/6	N/A	UNICO	N/A
43012	PALO EXTENSIBLE 3,6 M. TOTAL EN 3 SECCIONES EXTENSIBLE ALUMINUM HANDLE 3,6M. 3 SECTIONS	CAJA/6	N/A	UNICO	N/A



15010E

15060



86666

REF	DESCRIP				
15010E	LIMPIACRISTALES REVERSIBLE REVERSIBLE WINDOW CLEANER	CAJA/10	30 CM.	UNICO	N/A
15060	LIMPIACRISTALES REVERSIBLE + PALO EXTENSIBLE + CAJA EXPOSITORA DESMONTADA REVERSIBLE WINDOW CLEANER WITH HANDLE	CAJA/12	30 CM.	UNICO	N/A
86666	CUBO 15 L. RECTANGULAR RECTANGULAR 15L. BUCKET	CAJA/1	N/A	UNICO	N/A

Gama Pro+

Pro+ Line







2021



1360

REF	DESCRIP				
2021	EMPUÑADURA PRO + ENGANCHE RÁPIDO PRO + QUICK RELEASE HANDLE	6 /CAJA		UNICO	N/A
1360	MANETA PRO + ENGANCHE RÁPIDO GIRATORIA PRO+ SWIVEL HANDLE	12 /CAJA		UNICO	N/A



REF	DESCRIP				
1225	VARILLA CON GOMA INOX SIN CLIPS LATERALES 25 CM MASTER STAINLESS STEEL CLIPLESS CHANNEL 25 CM	12 /CAJA	25 CM	UNICO	N/A
1229	VARILLA CON GOMA INOX SIN CLIPS LATERALES 30 CM MASTER STAINLESS STEEL CLIPLESS CHANNEL 30 CM	12 /CAJA	30 CM	UNICO	N/A
1233	VARILLA CON GOMA INOX SIN CLIPS LATERALES 35 CM MASTER STAINLESS STEEL CLIPLESS CHANNEL 35 CM	12 /CAJA	35 CM	UNICO	N/A
1237	VARILLA CON GOMA INOX SIN CLIPS LATERALES 40 CM MASTER STAINLESS STEEL CLIPLESS CHANNEL 40 CM	12 /CAJA	40 CM	UNICO	N/A
1241	VARILLA CON GOMA INOX SIN CLIPS LATERALES 45 CM MASTER STAINLESS STEEL CLIPLESS CHANNEL 45 CM	12 /CAJA	45 CM	UNICO	N/A
1248	VARILLA CON GOMA INOX SIN CLIPS LATERALES 55 CM MASTER STAINLESS STEEL CLIPLESS CHANNEL 55 CM	12 /CAJA	55 CM	UNICO	N/A

Sistema inox clásico sin clips laterales

Clipless classic inox system



1329



1352



1360

REF	DESCRIP				
1329	EMPUÑADURA ACERO INOXIDABLE STAINLESS HANDLE	12 /CAJA	N/A	UNICO	N/A
1352	EMPUÑADURA ACERO INOXIDABLE CON ENGANCHE RÁPIDO STAINLESS TOP CLIP HANDLE	12 /CAJA	N/A	UNICO	N/A
1360	EMPUÑADURA GIRATORIA SISTEMA SUPER SUPER SYSTEM HANDLE	12 /CAJA	N/A	UNICO	N/A



REF	DESCRIP				
1225	VARILLA CON GOMA INOX SIN CLIPS LATERALES 25 CM MASTER STAINLESS STEEL CLIPLESS CHANNEL 25 CM	12 /CAJA	25 CM	UNICO	N/A
1229	VARILLA CON GOMA INOX SIN CLIPS LATERALES 30 CM MASTER STAINLESS STEEL CLIPLESS CHANNEL 30 CM	12 /CAJA	30 CM	UNICO	N/A
1233	VARILLA CON GOMA INOX SIN CLIPS LATERALES 35 CM MASTER STAINLESS STEEL CLIPLESS CHANNEL 35 CM	12 /CAJA	35 CM	UNICO	N/A
1237	VARILLA CON GOMA INOX SIN CLIPS LATERALES 40 CM MASTER STAINLESS STEEL CLIPLESS CHANNEL 40 CM	12 /CAJA	40 CM	UNICO	N/A
1241	VARILLA CON GOMA INOX SIN CLIPS LATERALES 45 CM MASTER STAINLESS STEEL CLIPLESS CHANNEL 45 CM	12 /CAJA	45 CM	UNICO	N/A
1248	VARILLA CON GOMA INOX SIN CLIPS LATERALES 55 CM MASTER STAINLESS STEEL CLIPLESS CHANNEL 55 CM	12 /CAJA	55 CM	UNICO	N/A

Sistema latón con clips laterales

Brass system with side clips



1324





1339



1640



1253

REF	DESCRIP				
1324	EMPUÑADURA CLÁSICA LATÓN CLASSIC BRASS HANDLE	12 /CAJA	N/A	UNICO	N/A
1339	EMPUÑADURA LATÓN CON GOMA + ENGANCHE RÁPIDO BRASS HANDLE WITH RUBBER & QUICK LOCK	12 /CAJA	N/A	UNICO	N/A
1640	MANETA PRO + ENGANCHE RÁPIDO GIRATORIA PRO + SWIVEL HANDLE & QUICK LOCK	12 /CAJA	N/A	UNICO	N/A
1253	CLIPS LATERALES PARA VARILLAS LATÓN SIDE CLIPS FOR BRASS CHANNELS	12 /CAJA	N/A	UNICO	N/A



REF	DESCRIP				
1127	VARILLA CON GOMA LATÓN + CLIPS LATERALES 25 CM MASTER BRASS CHANNEL WITH CLIPS 25 CM	12 /CAJA	25 CM	UNICO	N/A
1131	VARILLA CON GOMA LATÓN + CLIPS LATERALES 30 CM MASTER BRASS CHANNEL WITH CLIPS 30 CM	12 /CAJA	30 CM	UNICO	N/A
1135	VARILLA CON GOMA LATÓN + CLIPS LATERALES 35 CM MASTER BRASS CHANNEL WITH CLIPS 30 CM	12 /CAJA	35 CM	UNICO	N/A
1140	VARILLA CON GOMA LATÓN + CLIPS LATERALES 40 CM MASTER BRASS CHANNEL WITH CLIPS 30 CM	12 /CAJA	40 CM	UNICO	N/A
1144	VARILLA CON GOMA LATÓN + CLIPS LATERALES 45 CM MASTER BRASS CHANNEL WITH CLIPS 30 CM	12 /CAJA	45 CM	UNICO	N/A
1152	VARILLA CON GOMA LATÓN + CLIPS LATERALES 55 CM MASTER BRASS CHANNEL WITH CLIPS 30 CM	12 /CAJA	55 CM	UNICO	N/A

Barras "T"

"T" bars



1957 1959 1961

4010 4014 4018



4310 4314 4318 1614 1618

REF	DESCRIP				
1957	SOPORTE "T" PLÁSTICO ESTÁNDAR 25 CM STANDARD GRIP "T" BAR 25 CM	6 /CAJA	25 CM	UNICO	N/A
1959	SOPORTE "T" PLÁSTICO ESTÁNDAR 35 CM STANDARD GRIP "T" BAR 35 CM	6 /CAJA	35 CM	UNICO	N/A
1961	SOPORTE "T" PLÁSTICO ESTÁNDAR 45 CM STANDARD GRIP "T" BAR 45 CM	6 /CAJA	45 CM	UNICO	N/A
4010	SOPORTE "T" PLÁSTICO PRO GRIP 25 CM PRO GRIP "T" BAR 25 CM	6 /CAJA	25 CM	UNICO	N/A
4014	SOPORTE "T" PLÁSTICO PRO GRIP 35 CM PRO GRIP "T" BAR 45 CM	6 /CAJA	35 CM	UNICO	N/A
4018	SOPORTE "T" PLÁSTICO PRO GRIP 45 CM PRO GRIP "T" BAR 45 CM	6 /CAJA	45 CM	UNICO	N/A
4310	SOPORTE "T" CON BARRA ALUMINIO PRO + 25 CM PRO+ ALUMINUM "T" BAR 25 CM	6 /CAJA	25 CM	UNICO	N/A
4314	SOPORTE "T" CON BARRA ALUMINIO PRO + 35 CM PRO+ ALUMINUM "T" BAR 35 CM	6 /CAJA	35 CM	UNICO	N/A
4318	SOPORTE "T" CON BARRA ALUMINIO PRO + 45 CM PRO+ ALUMINUM "T" BAR 45 CM	6 /CAJA	45 CM	UNICO	N/A
1614	SOPORTE "T" CON BARRA ALUMINIO PRO + 35 CM GIRATORIO PRO+ ALUMINUM "T" BAR 35 CM	6 /CAJA	35 CM	UNICO	N/A
1618	SOPORTE "T" CON BARRA ALUMINIO PRO + 45 CM GIRATORIP PRO+ ALUMINUM "T" BAR 45 CM	6 /CAJA	45 CM	UNICO	N/A

Recambio gomas Ettore



Ettore replacement rubber



REF	DESCRIP				
1407	GOMA MASTER ETTORE 25 CM ETTORE MASTER RUBBER 25 CM	12 /CAJA	25 CM	UNICO	N/A
1412	GOMA MASTER ETTORE 30 CM ETTORE MASTER RUBBER 30 CM	12 /CAJA	30 CM	UNICO	N/A
1417	GOMA MASTER ETTORE 35 CM ETTORE MASTER RUBBER 35 CM	12 /CAJA	35 CM	UNICO	N/A
1422	GOMA MASTER ETTORE 40 CM ETTORE MASTER RUBBER 40 CM	12 /CAJA	40CM	UNICO	N/A
1427	GOMA MASTER ETTORE 45 CM ETTORE MASTER RUBBER 45 CM	12 /CAJA	45 CM	UNICO	N/A
1432	GOMA MASTER ETTORE 50 CM ETTORE MASTER RUBBER 50 CM	12 /CAJA	50 CM	UNICO	N/A
1438	GOMA MASTER ETTORE 55 CM ETTORE MASTER RUBBER 55 CM	12 /CAJA	55 CM	UNICO	N/A
4988	GOMA MASTER ETTORE 60 CM ETTORE MASTER RUBBER 60 CM	12 /CAJA	60 CM	UNICO	N/A
4989	GOMA MASTER ETTORE 75 CM ETTORE MASTER RUBBER 75 CM	12 /CAJA	75 CM	UNICO	N/A
1443	GOMA MASTER ETTORE 90 CM ETTORE MASTER RUBBER 90 CM	12 /CAJA	90 CM	UNICO	N/A
1408	GOMA MASTER PACK 144 UDS. 25 CM MASTER RUBBER PACK 144 PCS. 25 CM	144 /CAJA	25 CM	UNICO	N/A
1413	GOMA MASTER PACK 144 UDS. 30 CM MASTER RUBBER PACK 144 PCS. 30 CM	144 /CAJA	30 CM	UNICO	N/A
1418	GOMA MASTER PACK 144 UDS. 35 CM MASTER RUBBER PACK 144 PCS. 35 CM	144 /CAJA	35 CM	UNICO	N/A
1428	GOMA MASTER PACK 144 UDS. 45 CM MASTER RUBBER PACK 144 PCS. 45 CM	144 /CAJA	45 CM	UNICO	N/A
1444	GOMA MASTER PACK 144 UDS. 90 CM MASTER RUBBER PACK 144 PCS. 90 CM	144 /CAJA	90 CM	UNICO	N/A
21014	GOMA ESP 35 CM ESP RUBBER 35 CM	25 /CAJA	35 CM	UNICO	N/A
21018	GOMA ESP 45 CM ESP RUBBER 45 CM	25 /CAJA	45 CM	UNICO	N/A

Backflip



REF	DESCRIP				
71101	BACKFLIP REVERSIBLE 25 CM INOX BACKFLIP STAINLESS STEEL 25 CM.	6 /CAJA	25 CM	UNICO	N/A
71141	BACKFLIP REVERSIBLE 35 CM INOX BACKFLIP STAINLESS STEEL 35 CM.	6 /CAJA	35 CM	UNICO	N/A
71181	BACKFLIP REVERSIBLE 45 CM INOX BACKFLIP STAINLESS STEEL 45 CM.	6 /CAJA	45 CM	UNICO	N/A

Rascadores



Scrapers



1044

1043

1045

REF	DESCRIP		
1044	RASCADOR PRO + 15 CM COMPLETO ETTORE PRO + SCRAPER 15 CM	6 /CAJA	UNICO
1043	PACK 25 CUCHILLAS CARBÓN PARA RASCADOR PRO + CON DISPENSADOR CARBON BLADE DISPENSER PACK 25 PCS	6 /CAJA	UNICO
1045	PACK 10 CUCHILLAS INOX PARA RASCADOR PRO + 15 CM CON DISPENSADOR BLADE DISPENSER STAINLES STEEL PACK 10 PCS	6 /CAJA	UNICO



46312



46322



4286



4515



57110



2007



20291

REF	DESCRIP		
46312	RASCADOR "CHAMPION" 13 CM COMPLETO ETTORE CHAMPION SCRAPER 13 CM	6 /CAJA	UNICO
46322	PACK 10 CUCHILLAS PARA RASCADOR CHAMPION PACK 10 REPLACEMENT BLADES CHAMPION SCRAPER 13 CM	6 /CAJA	UNICO
4286	RASCADOR DE SEGURIDAD DE BOLSILLO POCKET SCRAPER	12 /CAJA	UNICO
4515	PACK 100 CUCHILLAS PARA RASCADOR SEGURIDAD BOLSILLO BLADE DISPENSER FOR POCKET SCRAPER PACK 100 PCS.	100 /CAJA	UNICO
57110	RASCADOR DE SUELOS 10 CM ANCHO SUPER FLOOR SCRAPER 10 CM WIDTH	6 /CAJA	UNICO
2007	RASCADOR DE SUELOS 10 CM ANCHO CON MANGO DE 135 CM SUPER FLOOR SCRAPER WITH HANDLE 135 CM 10 CM WIDTH	6 /CAJA	UNICO
20291	PACK 10 CUCHILLAS PARA RASCADOR DE SUELO 10 CM. ANCHO PACK 10 CM REPLACEMENT BLADES FLOOR SCRAPER 10 CM	6 /CAJA	UNICO

Vellones

Gloves



51010 51014 51018

40010 40014 40018

58014 58018

REF	DESCRIP				
51010	VELLON LAVAVIDRIOS AMARILLO 25 CM YELLOW GLOBE 25 CM.	6 /CAJA	25 CM	UNICO	N/A
51014	VELLON LAVAVIDRIOS AMARILLO 35 CM YELLOW GLOBE 35 CM.	6 /CAJA	35 CM	UNICO	N/A
51018	VELLON LAVAVIDRIOS AMARILLO 45 CM YELLOW GLOBE 45 CM.	6 /CAJA	45 CM	UNICO	N/A
40010	VELLON LAVAVIDRIOS MICROFIBRA 25 CM MICROFIBER GLOBE 25 CM.	6 /CAJA	25 CM	UNICO	N/A
40014	VELLON LAVAVIDRIOS MICROFIBRA 35 CM MICROFIBER GLOBE 35 CM.	6 /CAJA	35 CM	UNICO	N/A
40018	VELLON LAVAVIDRIOS MICROFIBRA 45 CM MICROFIBER GLOBE 45 CM.	6 /CAJA	45 CM	UNICO	N/A
58014	VELLON LAVAVIDRIOS ABRASIVO 35 CM ABRASIVE GLOBE 35 CM.	6 /CAJA	35 CM	UNICO	N/A
58018	VELLON LAVAVIDRIOS ABRASIVO 45 CM ABRASIVE GLOBE 45 CM.	6 /CAJA	45 CM	UNICO	N/A

Accesorios

Accessories



02041

PORTA UTENSILIOS SIDEKICK MÓVIL

SIDEKICK SWIVEL HOLSTER

6 /CAJA



UNICO

N/A



2044

CINTURÓN PARA PORTA UTENSILIOS

ETTORE TOOL BELT (ONLY WITH LOOP)

6 /CAJA



UNICO

N/A



50135

BOLSA PORTA-UTENSILIOS

HOLSTER SCRAPER DOUBLE POUCH

6 /CAJA



UNICO

N/A

REF	DESCRIP				
49016	AGARRADOR DE OBJETOS 41 CM GRIP 'N GRAB ERGONOMIC HANDLE 41 CM.	6 /CAJA		UNICO	N/A
49036	AGARRADOR DE OBJETOS 81 CM GRIP 'N GRAB ERGONOMIC HANDLE 81 CM.	6 /CAJA		UNICO	N/A

Cubos

Buckets



85000



85100



85300



85200



86666



86000



86100

REF	DESCRIP				
85000	SUPER CUBO 25 L. SUPER BUCKET 25 L.	6 /CAJA		UNICO	N/A
85100	TAPA PARA CUBO 25 L. SUPER BUCKET 25L. LID	1 /CAJA		UNICO	N/A
85300	ESCURRIDOR PARA CUBO 25 L. SIEVE FOR SUPER BUCKET	1 /CAJA		UNICO	N/A
85200	SET 4 RUEDAS PARA CUBO 25 L. CASTERS (4 PCS)	1 /CAJA		UNICO	N/A
86666	CUBO 15 L. RECTANGULAR RECTANGLE BUCKET 15 L.	10 /CAJA		UNICO	N/A
86000	SUPER CUBO COMPACTO 12 L. SUPER COMPACT BUCKET 12 L.	3 /CAJA		UNICO	N/A
86100	TAPA PARA CUBO COMPACTO 12 L. LID FOR SUPER COMPACT BUCKET 12 L.	1 /CAJA		UNICO	N/A

Palos extensibles R-E-A-C-H

Extensible poles R-E-A-C-H







42104 42108 42112



1680 1684 1688 1692



42003

REF	DESCRIP				
42104	PALO EXTENSIBLE 2 SECCIONES 1,2 M. (2 X 60 CM) REACH EXTENSIBLE POLE 2 SECTIONS 1,2 M (2 X 60 CM) REACH	6 /CAJA		UNICO	N/A
42108	PALO EXTENSIBLE 2 SECCIONES 2,4 M. (2 X 120 CM) REACH EXTENSIBLE POLE 2 SECTIONS 2,4 M (2 X 120 CM) REACH	6 /CAJA		UNICO	N/A
42112	PALO EXTENSIBLE 2 SECCIONES 3,6 M. (2 X 180 CM) REACH EXTENSIBLE POLE 2 SECTIONS 3,6 M (2 X 180 CM) REACH	6 /CAJA		UNICO	N/A
1680	PALO EXTENSIBLE 3 SECCIONES 2,7 M. (3 X 90 CM) REACH EXTENSIBLE POLE 3 SECTIONS 2,7M (2 X 90 CM) REACH	6 /CAJA		UNICO	N/A
1684	PALO EXTENSIBLE 3 SECCIONES 3,6 M. (3 X 120 CM) REACH EXTENSIBLE POLE 3 SECTIONS 3,6 M (3 X 120 CM) REACH	6 /CAJA		UNICO	N/A
1688	PALO EXTENSIBLE 3 SECCIONES 4,5 M. (3 X 150 CM) REACH EXTENSIBLE POLE 3 SECTIONS 4,5 M (3 X 150 CM) REACH	6 /CAJA		UNICO	N/A
1692	PALO EXTENSIBLE 3 SECCIONES 5,4 M. (3 X 180 CM) REACH EXTENSIBLE POLE 3 SECTIONS 5,4 M (3 X 180 CM) REACH	6 /CAJA		UNICO	N/A
42003	PALO EXTENSIBLE 2 SECCIONES 60 CM. INTERLOCK EXTENSIBLE POLE 2 SECTIONS 60CM INTERLOCK	6 /CAJA		UNICO	N/A



44112 44124 44132



1700



65004



43009 43012

REF	DESCRIP				
44112	PALO EXTENSIBLE 4 SECCIONES 3,6 M. INTERLOCK EXTENSIBLE POLE 4 SECTIONS 3,6 M INTERLOCK	6 /CAJA		UNICO	N/A
44118	PALO EXTENSIBLE 4 SECCIONES 5,4 M. INTERLOCK EXTENSIBLE POLE 4 SECTIONS 5,4 M INTERLOCK	6 /CAJA		UNICO	N/A
44124	PALO EXTENSIBLE 4 SECCIONES 7,3 M. INTERLOCK EXTENSIBLE POLE 4 SECTIONS 7,3 M INTERLOCK	2 /CAJA		UNICO	N/A
44132	PALO EXTENSIBLE 4 SECCIONES 9,7 M. INTERLOCK EXTENSIBLE POLE 4 SECTIONS 9,7 M INTERLOCK	2 /CAJA		UNICO	N/A
1700	ENGANCHE RÁPIDO PARA PALO EXTENSIBLE GAMA PRO + POLE TIP WITH QUICK LOCK (PRO + LINE)	6 /CAJA		UNICO	N/A
65004	PALO FIJO 1,2 M. ALUMINIO CON ENGANCHE RÁPIDO FIXED ALUMINUM HANDLE 1,2 M. QUICK RELEASE	6 /CAJA		UNICO	N/A
43009	PALO EXTENSIBLE 3 SECCIONES 2,4 M. 3 SECCIONES EXTENSIBLE ALUMINUM HANDLE 2,4M. 3 SECTIONS	6 /CAJA		UNICO	N/A
43012	PALO EXTENSIBLE 3 SECCIONES 3,6 M. 3 SECCIONES EXTENSIBLE ALUMINUM HANDLE 3,6M. 3 SECTIONS	6 /CAJA		UNICO	N/A

Adaptadores y plumeros





Adaptors and dusters



48626



48121





REF	DESCRIP				
48626	PLUMERO DE PLUMAS FEATHER	6 /CAJA		UNICO	N/A
48121	PLUMERO ESTÁTICO STATIC DUSTER	6 /CAJA		UNICO	N/A







Haraganes

Squeegees







REF	DESCRIP				
1633	HARAGÁN METÁLICO 45 CM METAL SQUEEGEE 45 CM.	10 /CAJA	45 CM	UNICO	N/A
1636	HARAGÁN METÁLICO 55 CM METAL SQUEEGEE 55 CM.	10 /CAJA	55 CM	UNICO	N/A



REF	DESCRIP				
05004	HARAGÁN REFORZADO 45 CM REINFORCED SQUEEGEE 45 CM.	10 /CAJA	45 CM	UNICO	N/A
05005	HARAGÁN REFORZADO 55 CM REINFORCED SQUEEGEE 55 CM.	10 /CAJA	55 CM	UNICO	N/A
05006	HARAGÁN REFORZADO 75 CM REINFORCED SQUEEGEE 75 CM.	10 /CAJA	75 CM	UNICO	N/A

NUEVO/NEW



REF	DESCRIP				
55018	HARAGÁN ALUMINIO CON GOMA RECAMBIO 45 CM ALUMINUM SQUEEGEE WITH REPALECEMENT RUBBER 45 CM.	6 /CAJA	45 CM	UNICO	N/A
55024	HARAGÁN ALUMINIO CON GOMA RECAMBIO 60 CM ALUMINUM SQUEEGEE WITH REPALECEMENT RUBBER 60	6 /CAJA	60 CM	UNICO	N/A
55030	HARAGÁN ALUMINIO CON GOMA RECAMBIO 75 CM ALUMINUM SQUEEGEE WITH REPALECEMENT RUBBER 75 CM.	6 /CAJA	75 CM	UNICO	N/A
55036	HARAGÁN ALUMINIO CON GOMA RECAMBIO 90 CM ALUMINUM SQUEEGEE WITH REPALECEMENT RUBBER 90 CM.	6 /CAJA	90 CM	UNICO	N/A



REF	DESCRIP				
56018	GOMA RECAMBIO HARAGÁN ALUMINIO 45 CM REPLACEMENT RUBBER FOR 45CM ALUMINUM SQUEEGEE	6 /CAJA	45 CM	UNICO	N/A
56024	GOMA RECAMBIO HARAGÁN ALUMINIO 60 CM REPLACEMENT RUBBER FOR 60CM ALUMINUM SQUEEGEE	6 /CAJA	60 CM	UNICO	N/A
56030	GOMA RECAMBIO HARAGÁN ALUMINIO 75 CM REPLACEMENT RUBBER FOR 75CM ALUMINUM SQUEEGEE	6 /CAJA	75 CM	UNICO	N/A
56036	GOMA RECAMBIO HARAGÁN ALUMINIO 90 CM REPLACEMENT RUBBER FOR 90CM ALUMINUM SQUEEGEE	6 /CAJA	90 CM	UNICO	N/A

HIGIENE ALIMENTARIA
FOOD INDUSTRY CLEANING

FOOD INDUSTRY RANGE

Actuando como distribuidor para España y Portugal de la empresa FBK, Maya Professional Tools ofrece una gran selección de **artículos para la limpieza en industrias alimentarias, químicas y farmacéuticas**. FBK se ha centrado en la producción de productos para higiene alimentaria desde sus inicios como empresa.

Maya Professional Tools as a distributor of FBK products in Spain and Portugal offers a strong and proven **selection of hygiene cleaning articles**. FBK has developed a range of products for an specific industry and has focused production on the professional sector ever since those early days.



**COLORES
DISPONIBLES**

¿Dónde se usan nuestros productos?

En cualquier lugar dónde se requiera un alto nivel de higiene. Las industrias que normalmente usan y aprecian nuestros productos son: procesamiento de alimentos y bebidas, puntos de venta, industria de restauración, el sector de servicios, los fabricantes de productos farmacéuticos y médicos, los hospitales, limpieza municipal, empresas dedicadas a limpieza en general, etc.

Where our products perform?

Anywhere and everywhere that uncompromising cleanliness is the overarching requirement. Typical market types that appreciate our products include: food and beverage processing, food handlers, service sector and retail outlets, pharmaceutical and medical manufacturers, hospitals, municipal cleaning, contract cleaners etc.

Codificación por color

Siempre atendiendo a los requerimientos de nuestros valiosos clientes, actualmente ofrecemos 10 colores: blanco, azul, rojo, amarillo, verde, naranja, morado, negro, gris y marrón.

Colour coding

Always attentive to the requirements of valued customers, we now offer up to 10 colours: white, blue, red, yellow, green, orange, purple, black, grey and brown.

Nivel de Tolerancia

Considerando los requerimientos de la industria, nuestros artículos cuentan con tolerancia al calor que va desde los -30°C/- 22°F hasta los +134°C/+273 °F (algunos hasta +250°C/+480° F). FBK fabrica sus productos con **polipropileno virgen coloreado inyectado a muy alta presión para producir piezas sólidas y muy resistentes**. Esta técnica de producción coloca a los productos de FBK muy lejos de los métodos de inyección estándar con burbujas en el interior que facilitan la rotura de los cepillos.

Tolerance data

In consideration for the requirements of the industry, articles are available with heat tolerances from -30°C/-22°F to +134°C/+273°F (even some up till +250°C/+480°F). FBK manufactures from colour coded virgin polypropylene injected under very high pressure to produce solid, strong mouldings. This production technique sets FBK products apart from foamed injection methods.



Ergonomía

FBK aspira a desarrollar artículos que no sólo encajan por el propósito mismo de limpiar, sino también que sean **ergonómicos y de fácil uso**. Nuestro equipo de diseño siempre considerará aquellos artículos que obtengan los mejores resultados con la menor fatiga posible.

Ergonomics

FBK aims to develop articles that are not only fit for purpose but are also **ergonomic and user-friendly**. Our design team will always consider what achieves the best results with the least fatigue.



Fibras de los cepillos

La mayoría de los cepillos se fabrica con **cerdas de poliéster PBT de diferentes longitudes y grosores** para adaptarse a diversas aplicaciones. Este material es extremadamente conveniente para soportar **altas temperaturas de desinfección** (+120°C/+248°F), no absorbe agua, por lo tanto es ideal en la conservación de la rigidez y la recuperación del doblado de las cerdas. Dura más tiempo y resiste la acción corrosiva de químicos de limpieza tanto ácidos como alcalinos.

Brush filaments

The majority of brushware is filled using **polyester PBT filaments of various lengths and thicknesses** to suit the application. This material is extremely **suitable for autoclaving** to +120°C/+248°F, does not absorb water, and is therefore ideal in retaining bristle stiffness and bend recovery. It wears longer and withstands destruction from a wide range of caustic cleaning chemicals.

Normativas

Los artículos de FBK son fabricados conforme a los mejores principios del HACCP, se fabrican con materiales compatibles con la FDA y las reglamentos Europeos como: Reglamento 10/2011/EC; 1935/2004/EC; 2023/2006; 579/2011/EC; EU directiva 93/43/EEC; 2002/72/EC; Código de alimentos de la FDA del 2009. Además, como miembro en activo de la Federación Europea de Cepillos, la empresa trabaja de acuerdo a el cuadro de la PHB emitido por la FEIBP.

Compliance

FBK articles conform to the best principles of HACCP, are manufactured from FDA compliant materials and are made in accordance with EU regulations 10/2011/EC; 1935/2004/EC; 2023/2006; 579/2011/EC; EU directive 93/43/EEC; 2002/72/EC; FDA food code 2009. As an active member of the European Brushware Federation, the company works in accordance with the PHB charter issued by FEIBP.

Cepillos buque

Deck scrubs







43153



15001



40154

REF	DESCRIP			
43153	CEPILLO BUQUE (300 X 60 MM) DECK SCRUB BRUSH (300 X 60 MM)	6 /CAJA	25 - PBT 0.50 DURO	
15001	CEPILLO BUQUE (280 X 50 MM) DECK SCRUB BRUSH (280 X 50 MM)	6 /CAJA	30 - PBT 0.50 DURO	
40154	CEP. DE BUQUE CON FIBRAS LATERALES (285 X 120 MM) DECK SCRUB (285 X 120 MM)	6 /CAJA	25/40 - PBT 0.50 DURO	

Cepillos buque 2 alturas

Deck scrub brushes 2 heights





NEW



40155



49154

REF	DESCRIP			
40155	CEP. PARA FROTAR "ANGULAR" (285 X 130 MM) MULTI DECK SCRUB "HIGH/LOW" BRUSH (285 X 130 MM)	6 /CAJA	45 - PBT 0.50 INTERMEDIO	
49154	CEP. BUQUE CON PASO DE AGUA (285 X 120 MM) DECK SCRUBS WITH WATERFED BRUSH (285 X 120 MM)	6 /CAJA	25/40 - PBT 0.50 DURO	



Filamentos de los cepillos

Evitar la caída de los filamentos.

Evitar la pérdida de filamentos es una tarea primordial para FBK. La combinación del perforado de precisión de cada uno de los bloques junto con la inserción de grapas de acero inoxidable logra este objetivo y al mismo tiempo permite la penetración de agentes anti-bacterianos para alcanzar hasta lo más profundo de los cúmulos de cedras.

Brush filaments

Filaments retention.

Filament retention is important to FBK and the combination of precision drilled high density brush blocks and insertion of stainless steel retaining clips achieves this objective whilst allowing for the penetration of anti-bacterial agents to reach deep into the bristle clumps.



15002

15002

CEPILLO BUQUE (400 X 500 MM)

DECK SCRUB BRUSH (400 X 500 MM)

6 / CAJA

30 - PBT 0.50 | DURO 4/3/15

UNICO

○ ● ● ● ● ● ● ●

Cepillos Suaves PBT

PBT Sweepers



15003



15004



47106



15203



15004



47136



95204

· SISTEMA RESINA ·



74166-2

· FILAMENTOS DETECTABLES ·



REF	DESCRIP			
15003	CEPILLO CON FIBRAS DESPUNTADAS (280 X 50 MM) SWEEPER WITH FLAGGED FILAMENTS (280 X 50 MM)	6 /CAJA	55 - PBT 0.30 SUAVE	
15004	CEPILLO CON FIBRAS DESPUNTADAS (400 X 50 MM) SWEEPER WITH FLAGGED FILAMENTS (400 X 50 MM)	6 /CAJA	55 - PBT 0.30 SUAVE	
47106	CEPILLO CON FIBRAS DESPUNTADAS (600 X 60 MM) SWEEPER WITH FLAGGED FILAMENTS (600 X 60 MM)	6 /CAJA	55 - PBT 0.30 SUAVE	
15203	CEPILLO FIBRA NO DESPUNTADA (280 X 50 MM) SWEEPER (280 X 50 MM)	6 /CAJA	55 - PBT 0.30 INTERMEDIO	
15204	CEPILLO FIBRA NO DESPUNTADA (400 X 50 MM) SWEEPER WITH FLAGGED FILAMENTS (400 X 50 MM)	6 /CAJA	55 - PBT 0.30 INTERMEDIO	
47136	CEPILLO FIBRA NO DESPUNTADA (600 X 60 MM) SWEEPER (600 X 60 MM)	6 /CAJA	55 - PBT 0.30 INTERMEDIO	
95204	CEPILLO SISTEMA RESINA (400 X 50 MM) SWEEPER RESIN SET (400 X 50 MM)	6 /CAJA	55 - PBT 0.30 INTERMEDIO	
74166-2	CEP. POLIÉSTER FILAMENTOS DETECTABLES (400 X 50 MM) METAL DETECTABLE SWEEPER (400 X 50 MM)	 6 /CAJA	55 - PBT 0.60 INTERMEDIO	

Cepillos rectos

Upright Brooms



44147



44157



40157



40190



94147



94157



78157-2

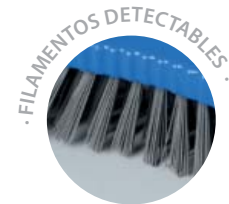

REF	DESCRIP			
44147	CEPILLO DE BARRER SUAVE (280 X 48 MM) SOFT UPRIGHT SWEEPER (280 X 48 MM)	6 /CAJA	70 - PBT 0.30 SUAVE	
44157	CEPILLO CON FIBRAS DESPUNTADAS (400 X 50 MM) SWEEPER WITH FLAGGED FILAMENTS (400 X 50 MM)	6 /CAJA	70 - PBT 0.50 INTERMEDIO	
40157	CEPILLO ESTRECHO FIBRA SEMIDURA (260 X 35 MM) NARROW UP-RIGHT SWEEPER / BROOM (260 X 35 MM)	6 /CAJA	80 - PBT 0.50 INTERMEDIO	
40190	CEPILLO ESTRECHO FIBRA DURA (260 X 35 MM) NARROW UP-RIGHT SWEEPER / BROOM (260 X 35 MM)	6 /CAJA	105 - PBT 1.00 DURO	
94147	CEPILLO BARRER SUAVE SISTEMA RESINA (280 X 48 MM) MEDIUM UPRIGHT SWEEPER - RESIN SET - (280 X 48 MM)	6 /CAJA	70 - PBT 0.30 SUAVE	
94157	CEPILLO DE BARRER SEMIDURO SISTEMA RESINA (280 X 48 MM) MEDIUM UPRIGHT SWEEPER - RESIN SET - (280 X 48 MM)	6 /CAJA	70 - PBT 0.50 INTERMEDIO	
78157-2	CEPILLO BARRER SEMIDURO AZUL FIBRAS DETECTABLES (280 X 48 MM) MEDIUM DETECTALBE BROOM (280 X 48 MM)	 6 /CAJA	70 - PBT 0.60 INTERMEDIO	

Cepillos barrenderos PBT

Medium PBT Brooms



15023



15009



15002

REF	DESCRIP			
15023	ESCOBA FIBRA MEDIA SUAVE (300 X 60 MM) MEDIUM BROOM (300 X 60 MM)	6 /CAJA	55 - PBT 0.50 INTERMEDIO	
15009	CEPILLO BARRENDERO FIBRA SEMIDURA (400 X 60 MM) MEDIUM BROOM (400 X 60 MM)	6 /CAJA	55 - PBT 0.50 INTERMEDIO	
47156	CEPILLO BARRENDERO FIBRA SEMIDURA (600 X 600 MM) MEDIUM BROOM (600 X 600 MM)	6 /CAJA	55 - PBT 0.50 INTERMEDIO	

Cepillos barrenderos duros PBT

PBT Stiff Brooms



15007



15008



15010

REF	DESCRIP			
15007	CEP. BARRENDERO FIBRA DURA (300 X 60 MM) STIFF BROOM (300 X 60 MM)	6 /CAJA	110 - PBT 1.00 DURO	
15008	CEP. BARRENDERO FIBRA DURA (400 X 60 MM) STIFF BROOM (400 X 60 MM)	6 /CAJA	110 - PBT 1.00 DURO	
15010	CEP. BARRENDERO FIBRA DURA (500 X 60 MM) STIFF BROOM (500 X 60 MM)	6 /CAJA	110 - PBT 1.00 DURO	

Cepillos para lavar

Washing brushes



REF	DESCRIP			
44104	CEPILLO FREGAR FIBRA SUAVE DESPUNTADA CON PASO DE AGUA (265 X 90 MM) WASHING BRUSH WITH WATERFED AND FLAGGED FILAMENTS (265 X 90 MM)	6 /CAJA	55 - PBT 0.30 SUAVE	
44144	CEPILLO FREGAR FIBRA MEDIA CON PASO AGUA (265 X 90 MM) WASHING BRUSH WITH WATERFED (265 X 90 MM)	6 /CAJA	55 - PBT 0.30 INTERMEDIO	
49105	CEP. FREGAR OVALADO CON PASO DE AGUA FIBRA SUAVE DESPUNTADAS WASHING BRUSH WITH WATERFERD AND FLAGGED FILAMENTS (290 X 60 MM)	6 /CAJA	45 - PBT 0.30 SUAVE	
15011	CEPILLO PARA FREGAR FIBRA SUAVE DESPUNTADA (225 X 60 MM) SOFT WASHING BRUSH WITH FLAGGED FILAMENTS (225 X 60 MM)	6 /CAJA	45 - PBT 0.30 SUAVE	
15012	CEPILLO PARA FREGAR FIBRA MEDIA (225 X 60 MM) MEDIUM WASHING BRUSH (225 X 60 MM)	6 /CAJA	50 - PBT 0.50 INTERMEDIO	
40105	CEPILLO CON FIBRAS SUAVES LATERALES DESPUNTADAS (290 X 130 MM) WASHING BRUSH W/SIDE FLAGGED FILAMENTS (290 X 130 MM)	6 /CAJA	45 - PBT 0.30 SUAVE	

Cepillos limpiatuberías para mango

Tube cleaning for handle



47121



47131



47132



47133



47152



47153

REF	DESCRIP			
47121	CEPILLO LIMPIATUBERÍAS C/ACOPLE MANGO (Ø 63 X 95 X 120 MM) TUBE CLEANING BRUSH FOR HANDLE (Ø 63 X 95 X 120 MM)	6 /CAJA	9 - PBT 0.20 INTERMEDIO	
47131	CEPILLO LIMPIATUBERÍAS C/ACOPLE MANGO (Ø 70 X 95 X 120 MM) TUBE CLEANING BRUSH FOR HANDLE (Ø 70 X 95 X 120 MM)	6 /CAJA	12 - PBT 0.30 INTERMEDIO	
47132	CEPILLO LIMPIATUBERÍAS C/ACOPLE MANGO (Ø 80 X 100 X 125 MM) TUBE CLEANING BRUSH FOR HANDLE (Ø 80 X 100 X 125 MM)	6 /CAJA	18 - PBT 0.30 INTERMEDIO	
47133	CEPILLO LIMPIATUBERÍAS C/ACOPLE MANGO (Ø 90 X 105 X 130 MM) TUBE CLEANING BRUSH FOR HANDLE (Ø 90 X 105 X 130 MM)	6 /CAJA	23 - PBT 0.30 INTERMEDIO	
47152	CEPILLO LIMPIATUBERÍAS C/ACOPLE MANGO (Ø 105 X 115 X 140 MM) TUBE CLEANING BRUSH FOR HANDLE (Ø 105 X 115 X 140 MM)	6 /CAJA	30 - PBT 0.50 INTERMEDIO	
47153	CEPILLO LIMPIATUBERÍAS C/ACOPLE MANGO (Ø 120 X 120 X 145 MM) TUBE CLEANING BRUSH FOR HANDLE (Ø 120 X 120 X 145 MM)	6 /CAJA	38 - PBT 0.50 INTERMEDIO	

Cepillos limpia tanques





Tank Brushes



15026



15025

REF	DESCRIP			
15026	CEPILLO LIMPIA TANQUE FIBRA DURA (200 X 120 MM) STIFF TANK BRUSH (200 X 120 MM)	6 /CAJA	35 - PBT 0.50 DURO	
15025	CEPILLO LIMPIA TANQUES FIBRA MEDIA (200 X 120 MM) MEDIUM TANK BRUSH (200 X 120 MM)	6 /CAJA	35 - PBT 0.30 INTERMEDIO	



47260

CEPILLO LIMPIATUBERÍAS EXTERIOR (Ø 100 X 340 X 600 MM)

TUBE CLEANING BRUSH FOR OUTSIDE CLEANING OF TUBE, FOR HANDLE

2 /CAJA
UNICO

PBT 0.30 | INTERMEDIO
● ● ● ●



48281

RASQUETA ACERO INOXIDABLE PARA MANGO

STAINLESS STEEL SCRAPER, FOR HANDLE

6 /CAJA
UNICO

110 - 1,5 mm inox | DURO
○ ● ● ● ● ● ● ●



48290



48291

REF	DESCRIP			
48290	RASQUETA DE POLIPROPILENO PARA MANGO PADDLE SCRAPER BLADE POLYPROPYLENE	12 /CAJA	DURO	○ ● ● ● ● ● ● ● ● ● ●
48291	RASQUETA DE POLIPROPILENO PARA MANGO PADDLE SCRAPER BLADE POLYETHYLENE	12 /CAJA	FLEXIBLE	○

Soporte portafibras - rascador de suelos
Pad holder - Floor pads



47101



15122

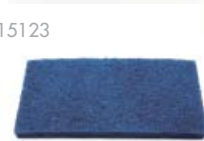

15124

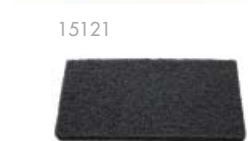

15125

REF	DESCRIP			
47101	PORTAFIBRAS PARA MANGO (230 X 100 MM) PAD GRIPPER FOR HANDLE (230 X 100 MM)	6/CAJA	N/A	○ ● ● ● ● ●
15123	FIBRA ABRASIVA MUY SUAVE (250 X 120 X 25 MM) VERY SOFT ABRASIVE PAD (250 X 120 X 25 MM)	12 /CAJA	MUY SUAVE	○
15121	FIBRA ABRASIVA SUAVE (250 X 120 X 25 MM) SOFT ABRASIVE PAD (250 X 120 X 25 MM)	12 /CAJA	SUAVE	●
15122	FIBRA ABRASIVA INTERMEDIA (250 X 120 X 25 MM) MEDIUM ABRASIVE PAD (250 X 120 X 25 MM)	12 /CAJA	MEDIO	●
15124	FIBRA ABRASIVA DURA (250 X 120 X 25 MM) STIFF ABRASIVE PAD (250 X 120 X 25 MM)	12 /CAJA	DURO	●
15125	FIBRA ABRASIVA MUY DURA (250 X 120 X 25 MM) VERY STIFF ABRASIVE PAD (250 X 120 X 25 MM)	12 /CAJA	MUY DURO	●



Haraganes de una pieza super higiénicos

One piece squeegee



48300

48400

48500

48600

48700

REF

DESCRIP



48300

HARAGÁN UNA PIEZA SUPER HIGIÉNICO (300 MM)
ONE PIECE SQUEEGEE SUPER HYGIENIC (300 MM)

6 /CAJA

N/A



48400

HARAGÁN UNA PIEZA SUPER HIGIÉNICO (400 MM)
ONE PIECE SQUEEGEE SUPER HYGIENIC (400 MM)

6 /CAJA

N/A



48500

HARAGÁN UNA PIEZA SUPER HIGIÉNICO (500 MM)
ONE PIECE SQUEEGEE SUPER HYGIENIC (500 MM)

6 /CAJA

N/A



48600

HARAGÁN UNA PIEZA SUPER HIGIÉNICO (600 MM)
ONE PIECE SQUEEGEE SUPER HYGIENIC (600 MM)

6 /CAJA

N/A



48700

HARAGÁN UNA PIEZA SUPER HIGIÉNICO (700 MM)
ONE PIECE SQUEEGEE SUPER HYGIENIC (700 MM)

6 /CAJA

N/A



Mangos ergonómicos de una pieza

One piece ergonomic handle









REF	DESCRIP			
49903	MANGO DE UNA PIEZA ERGONÓMICO SUPER HIGIÉNICO (1300 X 32 MM) ONE PIECE ERGONOMIC HANDLE, UPER HYGIENIC (1300 X 32 MM)	6 /CAJA	N/A	
49904	MANGO DE UNA PIEZA ERGONÓMICO SUPER HIGIÉNICO (1500 X 32 MM) ONE PIECE ERGONOMIC HANDLE, SUPER HYGIENIC (1500 X 32 MM)	6 /CAJA	N/A	
49905	MANGO DE UNA PIEZA ERGONÓMICO SUPER HIGIÉNICO (1700 X 32 MM) ONE PIECE ERGONOMIC HANDLE, SUPER HYGIENIC (1700 X 32 MM)	6 /CAJA	N/A	

Mangos ergonómicos de aluminio

Aluminum telescopic handles



REF	DESCRIP			
49812	MANGO ERGONÓMICO ALUMINIO (650 X 32 MM) ERGONOMIC HANDLE, ALUMINIUM (650 X 32 MM)	6 /CAJA	N/A	
49813	MANGO ERGONÓMICO ALUMINIO (1300 X 32 MM) ERGONOMIC HANDLE, ALUMINIUM (1300 X 32 MM)	6 /CAJA	N/A	
50321	MANGO ERGONÓMICO ALUMINIO (1500 X 32 MM) ERGONOMIC HANDLE, ALUMINIUM (1500 X 32 MM)	6 /CAJA	N/A	
50331	MANGO ERGONÓMICO ALUMINIO (1750 X 32 MM) ERGONOMIC HANDLE, ALUMINIUM (1750 X 32 MM)	6 /CAJA	N/A	

Mangos de aluminio

Aluminum handles



REF	DESCRIP			
49801	MANGO ALUMINIO CON MANETA (300 X 25 MM) ALUMINIUM HANDLE WITH STANDARD GRIP (300 X 25 MM)	6 /CAJA	N/A	
15033	MANGO ALUMINIO CON MANETA (1750 X 25 MM) ALUMINIUM HANDLE WITH STANDARD GRIP (1750 X 25 MM)	6 /CAJA	N/A	
49803	MANGO ALUMINIO CON MANETA (1300 X 25 MM) ALUMINIUM HANDLE WITH STANDARD GRIP (1300 X 25 MM)	6 /CAJA	N/A	
15032	MANGO ALUMINIO CON MANETA (1500 X 25 MM) ALUMINIUM HANDLE WITH STANDARD GRIP (1500 X 25 MM)	6 /CAJA	N/A	

Mangos telescópicos

Telescopic handles



49856



15045 15037

REF	DESCRIP			
49856	MANGO TELESCÓPICO ERGONÓMICO DE ALUMINIO (1750->3000 X 32 MM) ERGONOMIC TELESCOPIC HANDLE, ALUMINIUM (1750->3000 X 32 MM)	6 /CAJA	N/A	
15045	MANGO TELESCÓPICO FIBRA VIDRIO CON MANETA (2500 ->4800 X 26 MM) TELESCOPIC HANDLE, FIBREGLASS (2500->4800 X 26 MM)	6 /CAJA	N/A	
15037	MANGO TELESCÓPICO FIBRA VIDRIO CON MANETA (1500 -> 2800 X 26 MM) TELESCOPIC HANDLE, FIBREGLASS (1500 -> 2800 X 26 MM)	6 /CAJA	N/A	



Mangos ergonómicos con paso de agua

Aluminum ergonomic waterfed handles



49824



49826

REF	DESCRIP			
49824	MANGO ALUMINIO ERGONÓMICO CON PASO AGUA (1500 X 32 MM) ERGONOMIC HANDLE ALUMINIUM WITH WATERFED (1500 X 32 MM)	6 /CAJA	N/A	<input type="radio"/> <input checked="" type="radio"/> <input type="radio"/> <input type="radio"/> <input type="radio"/>
49826	MANGO TELESCÓPICO ERGONÓMICO CON PASO DE AGUA (1750->3000 X 32 MM) ERGONOMIC TELESCOPIC HANDLE, ALUMINIUM WITH WATERFED 1750->3000 X 32 MM	6 /CAJA	N/A	<input type="radio"/> <input checked="" type="radio"/> <input type="radio"/> <input type="radio"/> <input type="radio"/>

Cepillos panaderos

Banister brushes



10254

10252

10255

10256

REF	DESCRIP			
10254	CEPILLO PANADERO FIBRA MUY SUAVE (340 X 35 MM) VERY SOFT BANISTER BRUSH (340 X 35 MM)	10 / CAJA	50 - PBT 0.20 MUY SUAVE	
10252	CEPILLO PANADERO FIBRA SEMIDURA (340 X 35 MM) MEDIUM BANISTER BRUSH (340 X 35 MM)	10 / CAJA	50 - PBT 0.30 INTERMEDIO	
10255	CEPILLO PANADERO FIBRA DURA (340 X 35 MM) STIFF BANISTER BRUSH (340 X 35 MM)	10 / CAJA	50 - PBT 0.50 DURO	
10256	CEPILLO PANADERO FIBRA SEMIDURA (2 TIPOS FIBRA 340 X 35 MM) MEDIUM BANISTER BRUSH (2 TYPES OF FILAMENTS)	10 / CAJA	50 - PBT 0.20/0.50 SUAVE/DURO	

Cepillos multiusos mango corto

Short utility brushes



10201

10203





REF	DESCRIP			
10201	CEPILLO MULTIUSOS MANGO CORTO FIBRA SEMIDURA (270 X 47 MM) MEDIUM SMALL UTILITY BRUSH (270 X 47 MM)	12 /CAJA	30 - PBT 0.30 INTERMEDIO	
10203	CEPILLO MULTIUSOS MANGO CORTO FIBRA DURA (270 X 47 MM) STIFF SMALL UTILITY BRUSH (270 X 47 MM)	12 /CAJA	30 - PBT 0.50 DURO	

Cepillos panaderos sistema resina

Bansiter brushes resin set



90252 90255

REF	DESCRIP			
90252	CEPILLO PANADERO RESINA FIBRA SEMIDURA (340 X 35 MM) MEDIUM RESIN BANISTER BRUSH (340 X 35 MM)	10 /CAJA	50 - PBT 0.30 INTERMEDIO	
90255	CEPILLO PANADERO RESINA FIBRA DURA (340 X 35 MM) STIFF SMALL UTILITY BRUSH (270 X 47 MM)	10 /CAJA	50 - PBT 0.50 DURO	





Cepillos de mano con mango

Churn brushes



10546

10548

REF	DESCRIP			
10546	CEPILLO LIMPIA LECHERA FIBRA SEMIDURA (275 X 70 MM) MEDIUM CHURN BRUSH (275 X 70 MM)	10 /CAJA	35 - PBT 0.30 INTERMEDIO	
10548	CEPILLO LIMPIA LECHERA FIBRA DURA (275 X 70 MM) STIFF CHURN BRUSH (275 X 70 MM)	10 /CAJA	35 - PBT 0.50 DURO	

Cepillo multiusos sistema resina

Churn brushes resin Set



REF	DESCRIP			
90546	CEPILLO DE MANO CON MANGO SISTEMA RESINA (275 X 70 MM) MEDIUM RESIN SET CHURN BRUSH (275 X 70 MM)	6 /CAJA	40 - PBT 0.30 INTERMEDIO	
90548	CEPILLO DE MANO CON MANGO SISTEMA RESINA (275 X 70 MM) STIFF RESIN SET CHURN BRUSH (275 X 70 MM)	6 /CAJA	35 - PBT 0.50 DURO	

Cepillos multiusos con mango largo

Long utility brushes



10215

10232

10233

REF	DESCRIP			
10215	CEPILLO MULTIUSOS MANGO LARGO FIBRA DURA (410 X 45 MM) STIFF LONG UTILITY BRUSH (410 X 45 MM)	6 /CAJA	40 - PBT 0.50 DURO	
10232	CEPILLO MULTIUSOS CABEZAL ANCHO FIBRA SEMIDURA (410 X 55 MM) MEDIUM LONG WIDE UTILITY BRUSH (410 X 55 MM)	10 /CAJA	50 - PBT 0.30 INTERMEDIO	
10233	CEPILLO MULTIUSOS CABEZAL ANCHO FIBRA SEMIDURA (410 X 55 MM) MEDIUM LONG WIDE UTILITY BRUSH (410 X 55 MM)	10 /CAJA	50 - PBT 0.50 DURO	

Cepillos multiusos ancho con mango largo sistema de resina

Wide utility brush resin set



REF	DESCRIP			
90232	CEPILLO MULTIUSOS CABEZAL ANCHO F.SEMIDURA SIST RESINA (410 X 55 MM) MEDIUM LONG WIDE UTILITY BRUSH RESIN SET (410 X 55 MM)	10 / CAJA	50 - PBT 0.30 INTERMEDIO	
90233	CEPILLO MULTIUSOS CABEZAL ANCHO F.DURA SIST RESINA (410 X 55 MM) STIFF LONG WIDE UTILITY BRUSH RESIN SET (410 X 55 MM)	10 / CAJA	50 - PBT 0.50 DURO	



52154

CEPILLO MANO BORDE GOMA PASO AGUA/ACOPLE FIBRA DURA (300 X 75 MM)

STIFF CHURN BRUSH WITH WATERFED AND RUBBER
HANDGRIP (300 X 75 MM)

 6 /CAJA

 35 - PBT 0.50 | DURO

 UNICO





Cepillos de mano

Hand scrub brushes



15064



15063



54153

REF	DESCRIP			
15064	CEPILLO MANO MULTIUSOS FIBRA SEMIDURA (210 X 70 MM) MEDIUM HAND SCRUB BRUSH (210 X 70 MM)	12 /CAJA	35 - PBT 0.30 INTERMEDIO	
15063	CEPILLO MANO MULTIUSOS FIBRA DURA (210 X 70 MM) STIFF HAND SCRUB BRUSH (210 X 70 MM)	12 /CAJA	35 - PBT 0.50 DURO	
54153	CEPILLO MANO FIBRA DURA (210 X 65 MM) TIFF HAND SCRUB BRUSH (210 X 65 MM)	12 /CAJA	30 - PBT 0.50 DURO	

Cepillos de mano redondos





Round hand scrub brushes



54134



54154

REF	DESCRIP			
54134	CEPILLO MANO REDONDO FIBRA SEMIDURA (Ø 125 MM) MEDIUM ROUND HAND SCRUB BRUSH (Ø 125 MM)	6 /CAJA	40 - PBT 0.30 INTERMEDIO	
54154	CEPILLO MANO REDONDO FIBRA DURA (Ø 125 MM) STIFF ROUND HAND SCRUB BRUSH (Ø 125 MM)	6 /CAJA	40 - PBT 0.50 DURO	

Cepillos limpiaplatos

Dish washing brushes



10463



10466

REF	DESCRIP			
10463	CEPILLO LIMPIA PLATOS FIBRA SEMIDURA CON RASPADOR (255 X 28 MM) MEDIUM DISH WASHING BRUSH WITH SCRAPER (255 X 28 MM)	12 /CAJA	25 - PBT 0.30 INTERMEDIO	
10466	CEPILLO LIMPIA PLATOS FIBRA SEMIDURA (225 X 35 MM) MEDIUM DISH WASHING BRUSH (225 X 35 MM)	6 /CAJA	25 - PBT 0.30 INTERMEDIO	

Cepillos de uñas





Nail brushes



15060



15061

REF	DESCRIP			
15060	CEPILLO UÑAS FIBRA INTERMEDIA (110 X 45 MM) MEDIUM DISH WASHING BRUSH WITH SCRAPER (255 X 28 MM)	12 /CAJA	25 - PBT 0.30 INTERMEDIO	
15061	CEPILLO UÑAS FIBRA DURA (110 X 45 MM) STIFF NAIL BRUSH (110 X 45 MM)	12 /CAJA	16 - PBT 0.50 DURO	



95063

CEPILLO MANO MULTIUSOS FIBRA DURA SISTEMA RESINA (210 X 70 MM)

Stiff Hand Scrub Brush Resin Set (210 x 70 mm)

 12 /CAJA

 35 - PBT 0.50 | DURO

 UNICO



50153

CEPILLO ESTRECHO PARA MAQUINARIA O PESCADO (275 X 20 MM)

Stiff Small Machine Brush (275 x 20 mm)

 12 /CAJA

 30 - PBT 0.50 | DURO

 UNICO





52126

CEPILLO PARA HARINA FIBRA MUY SUAVE (300 X 20 MM)

Very Soft Flour Brush (300 x 20 mm)

12 /CAJA

60 - PBT 0.20 | MUY SUAVE

UNICO

○ ● ● ● ● ●



51126

CEPILLO PANADERO FIBRA MUY SUAVE (410 X 55 MM)

Very Soft Bread Brush (410 x 55 mm)

10 /CAJA

60 - PBT 0.20 | MUY SUAVE

UNICO

○ ● ● ● ● ●

Cepillos pastelería
Pastry brushes



80125



81125



82125

REF	DESCRIP			
80125	CEPILLO PARA PASTELERIA FIBRA SUAVE (30 MM) SOFT PASTRY BRUSH (30 MM)	12 /CAJA	50 - PBT 0.15 SUAVE	○ ● ●
81125	CEPILLO PARA PASTELERÍA FIBRA SUAVE (50 MM) SOFT PASTRY BRUSH (50 MM)	12 /CAJA	50 - PBT 0.15 SUAVE	○ ● ●
82125	CEPILLO PARA PASTELERÍA FIBRA SUAVE (70 MM) SOFT PASTRY BRUSH (70 MM)	12 /CAJA	50 - PBT 0.15 SUAVE	○ ● ●

Cepillo limpiatubos punta recta

Tube brushes



10750



10752



10754



10756



10758



10759

REF	DESCRIP			
10750	CEPILLO LIMPIA TUBOS FIBRA INTERMEDIA (Ø 10 X 150 X 500 MM) MEDIUM TUBE BRUSH (Ø 10 X 150 X 500 MM)	12 /CAJA	PBT 0.20 INTERMEDIO	
10752	CEPILLO LIMPIA TUBOS FIBRA INTERMEDIA (Ø 20 X 150 X 500 MM) MEDIUM TUBE BRUSH (Ø 20 X 150 X 500 MM)	12 /CAJA	PBT 0.30 INTERMEDIO	
10754	CEPILLO LIMPIA TUBOS FIBRA INTERMEDIA (Ø 30 X 150 X 500 MM) MEDIUM TUBE BRUSH (Ø 30 X 150 X 500 MM)	12 /CAJA	PBT 0.30 INTERMEDIO	
10756	CEPILLO LIMPIA TUBOS FIBRA INTERMEDIA (Ø 40 X 150 X 500 MM) MEDIUM TUBE BRUSH (Ø 40 X 150 X 500 MM)	12 /CAJA	PBT 0.30 INTERMEDIO	
10758	CEPILLO LIMPIA TUBOS FIBRA INTERMEDIA (Ø 50 X 150 X 500 MM) MEDIUM TUBE BRUSH (Ø 50 X 150 X 500 MM)	12 /CAJA	PBT 0.50 INTERMEDIO	
10759	CEPILLO LIMPIA TUBOS FIBRA INTERMEDIA (Ø 60 X 150 X 500 MM) MEDIUM TUBE BRUSH (Ø 60 X 150 X 500 MM)	12 /CAJA	PBT 0.50 INTERMEDIO	

Cepillos limpiatuberías con rosca

Tube brushes with thread



10771



10772



10774



10775



10776



10778



10780



10781



10784



10785

REF	DESCRIP			
10771	CEPILLO LIMPIA TUBERÍA PARA ENROSCAR A CABLE (Ø 12 X 100 X 160 MM) MEDIUM TUBE BRUSH WITH THREAD (Ø 12 X 100 X 160 MM)	12 /CAJA	PBT 0.20 INTERMEDIO	
10772	CEPILLO LIMPIA TUBERÍA PARA ENROSCAR A CABLE (Ø 20 X 100 X 160 MM) MEDIUM TUBE BRUSH WITH THREAD (Ø 20 X 100 X 160 MM)	12 /CAJA	PBT 0.30 INTERMEDIO	
10774	CEPILLO LIMPIA TUBERÍA PARA ENROSCAR A CABLE (Ø 40 X 100 X 160 MM) MEDIUM TUBE BRUSH WITH THREAD (Ø 40 X 100 X 160 MM)	12 /CAJA	PBT 0.30 INTERMEDIO	
10775	CEPILLO LIMPIA TUBERÍA PARA ENROSCAR A CABLE (Ø 50 X 100 X 160 MM) MEDIUM TUBE BRUSH WITH THREAD (Ø 50 X 100 X 160 MM)	12 /CAJA	PBT 0.50 INTERMEDIO	
10776	CEPILLO LIMPIA TUBERÍA PARA ENROSCAR A CABLE (Ø 60 X 100 X 160 MM) MEDIUM TUBE BRUSH WITH THREAD (Ø 60 X 100 X 160 MM)	12 /CAJA	PBT 0.50 INTERMEDIO	
10778	CEPILLO LIMPIA TUBERÍA PARA ENROSCAR A CABLE (Ø 80 X 100 X 160 MM) MEDIUM TUBE BRUSH WITH THREAD (Ø 80 X 100 X 160 MM)	12 /CAJA	PBT 0.50 INTERMEDIO	
10781	MANGO FLEXIBLE ACERO INOXIDABLE (300 CM) TWISTED STAINLESS STEEL WIRE (300 CM)	12 /CAJA	INOX	
10780	MANGO FLEXIBLE ACERO INOXIDABLE (150 CM) TWISTED STAINLESS STEEL WIRE (150 CM)	12 /CAJA	INOX	
10784	CABLE NYLON (150 CM) FLEXIBLE NYLON ROD (150 CM)	12 /CAJA	NYLON	
10785	CABLE EXTENSIÓN NYLON (150 CM) FLEXIBLE EXTENSION NYLON ROD (150 CM)	12 /CAJA	NYLON	



Cepillos limpiatuberías con mango





Tube cleaners



57156



57159

REF	DESCRIP			
57156	CEPILLO LIMPIA TUBERÍAS CON MANGO FIBRA DURA (Ø 63 X 80 X 370 MM) STIFF TUBE CLEANER (Ø 63 X 80 X 370 MM)	12 /CAJA	20 - PBT 0,30 DURO	
57159	CEPILLO LIMPIA TUBERÍAS CON MANGO FIBRA DURA (Ø 90 X 80 X 370 MM) STIFF TUBE CLEANER (Ø 90 X 80 X 370 MM)	12 /CAJA	35 - PBT 0,50 DURO	



50155

CEPILLO LIMPIA CUCHILLAS FIBRA DURA (510 X Ø 100 MM)

STIFF CUTTER BRUSH (510 X Ø 100 MM)

12 /CAJA

45 - PBT 0.50 | DURO

UNICO

○ ● ● ● ● ●



Portafibras manual + fibras
Pad holders + abrasive pads



57101



15123

15121

15122

15124

15125

REF	DESCRIP			
57101	PORTA FIBRA USO MANUAL (230 X 100 MM) PAD HOLDER WITH HANDGRIP (230 X 100 MM)	12 /CAJA	N/A	○ ● ● ● ● ●
15123	FIBRA ABRASIVA MUY SUAVE (250 X 120 X 25 MM) VERY SOFT ABRASIVE PAD (250 X 120 X 25 MM)	12 /CAJA	MUY SUAVE	○
15121	FIBRA ABRASIVA SUAVE (250 X 120 X 25 MM) SOFT ABRASIVE PAD (250 X 120 X 25 MM)	12 /CAJA	SUAVE	●
15122	FIBRA ABRASIVA INTERMEDIA (250 X 120 X 25 MM) MEDIUM ABRASIVE PAD (250 X 120 X 25 MM)	12 /CAJA	MEDIO	●
15124	FIBRA ABRASIVA DURA (250 X 120 X 25 MM) STIFF ABRASIVE PAD (250 X 120 X 25 MM)	12 /CAJA	DURO	●
15125	FIBRA ABRASIVA MUY DURA (250 X 120 X 25 MM) VERY STIFF ABRASIVE PAD (250 X 120 X 25 MM)	12 /CAJA	MUY DURO	●



Espátulas de plástico

Plastic spatulas



82904



15109



82910-6



15109-6

REF	DESCRIP			
82904	ESPÁTULA PLÁSTICO (75 X 250 MM) SPATULA (75 X 250 MM)	12 /CAJA	POLIPROPILENO	
15109	ESPÁTULA PLÁSTICO (110 X 250 MM) SPATULA (110 X 250 MM)	12 /CAJA	POLIPROPILENO	
82910-6	ESPÁTULA NYLON (75 X 250 MM) NEGRO PARA 240°C NYLON SPATULA (75 X 250 MM) BLACK UP TO 240°C	12 /CAJA	NYLON	
15109-6	ESPÁTULA NYLON (110 X 250 MM) NEGRO PARA 240° C NYLON SPATULA (110 X 250 MM) BLACK UP TO 240° C	12 /CAJA	NYLON	



Rasqueta flexible

Flexible dough scrapers

NEW



81910





81911



81915



81916

REF	DESCRIP			
81910	RASQUETA FLEXIBLE PARA MASA CON AGUJERO (146 X 98 X 1,65 MM) FLEXIBLE DOUGH SCRAPER WITH HOLE (146 X 98 X 1,65 MM)	20 / CAJA	POLIPROPILENO FLEXIBLE	
81911	RASQUETA FLEXIBLE PARA MASA SIN AGUJERO (146 X 98 X 1,65 MM) FLEXIBLE DOUGH SCRAPER WITHOUT HOLE (146 X 98 X 1,65 MM)	20 / CAJA	POLIPROPILENO FLEXIBLE	
81915	RASQUETA FLEXIBLE PARA MASA REDONDA CON AGUJERO (160 X 125 X 1,65 MM) ROUND FLEXIBLE DOUGH SCRAPER WITH HOLE (160 X 125 X 1,65 MM)	20 / CAJA	POLIPROPILENO FLEXIBLE	
81916	RASQUETA FLEXIBLE PARA MASA REDONDA SIN AGUJERO (160 X 125 X 1,65 MM) ROUND FLEXIBLE DOUGH SCRAPER WITHOUT HOLE (160 X 125 X 1,65 MM)	12 / CAJA	POLIPROPILENO FLEXIBLE	

Cucharas de mano

Hand scoops



15105



15106



15107

REF	DESCRIP			
15105	PALA DE MANO (110 X 150 X 265 MM) 500 GRAM HAND SCOOP (110 X 150 X 265 MM) 500 GRAM	10 /CAJA	POLIPROPILENO	
15106	PALA DE MANO (135 X 185 X 310 MM) 750 GRAM HAND SCOOP (135 X 185 X 310 MM) 750 GRAM	10 /CAJA	POLIPROPILENO	
15107	PALA DE MANO (160 X 230 X 360 MM) 1000 GRAM HAND SCOOP (160 X 230 X 360 MM) 1000 GRAM	10 /CAJA	POLIPROPILENO	

Recogedor

Dustpan



80201



80200



80203

REF	DESCRIP			
80201	RECOGEDOR ABATIBLE SIN MANGO (330 X 310 X 125 MM) DUSTPAN WITHOUT HANDLE (330 X 310 X 125 MM)	2 / CAJA	POLIPROPILENO	
80200	RECOGEDOR ABATIBLE CON MANGO ALUMINIO (330 X 310 X 125 MM) LONG HANDLE DUSTPAN (300 X 310 X 125 MM)	2 / CAJA	POLIPROPILENO + ALUMINIO	
80203	MANGO ALUMINIO PARA RECOGEDOR ABATIBLE (800 X 25 MM) ALUMINIUM HANDLE FOR DUSTPAN (800 X 25 MM)	10 / CAJA	ALUMINIO	



80205

RECOGEDOR DE MANO

DUSTPAN WITH LID AND HANDGRIP (330 X 310 X 125 MM)

6 /CAJA

POLIPROPILENO

UNICO

Color selection icons: white, blue, red, yellow, green, black, purple, grey.



Cubo 15l. y tapa
15 l. bucket and lid



80101



80111

REF	DESCRIP	6 /CAJA	POLIPROPILENO	Color selection icons
80101	CUBO ALIMENTARIA 15 LITROS BUCKET 15 LITRE	4 /CAJA	POLIPROPILENO	Color selection icons
80111	TAPA CUBO ALIMENTARIA LID FOR BUCKET	4 /CAJA	POLIPROPILENO	Color selection icons

Palas de mano

Hand shovels



80305



80301

REF	DESCRIP			
80305	PALA DE MANO (270 X 320 X 540 MM) HAND SCOOP (270 X 320 X 540 MM)	10 /CAJA	POLIPROPILENO	
80301	PALA DE MANO EXTRA FUERTE (300 X 310 MM) STRONG DUSTPAN (300 X 310 MM)	6 /CAJA	DURO	

Palas ergonómicas

Ergonomic shovels



14103



14104



15103



15104

REF	DESCRIP			
14103	PALA MONOBLOQUE, MANGO CORTO (270 X 340 X 1120 MM) ERGONOMIC ONE PIECE SHOVEL, SHORT HANDLE (270 X 340 X 1120 MM)	6 /CAJA	POLIPROPILENO	
14104	PALA MONOBLOQUE, MANGO CORTO (330 X 380 X 1120 MM) ERGONOMIC ONE PIECE SHOVEL, SHORT HANDLE (330 X 380 X 1120 MM)	6 /CAJA	POLIPROPILENO	
15103	PALA MONOBLOQUE, MANGO LARGO (270 X 340 X 1330 MM) ERGONOMIC ONE PIECE SHOVEL, LONG HANDLE (270 X 340 X 1330 MM)	6 /CAJA	POLIPROPILENO	
15104	PALA MONOBLOQUE, MANGO LARGO (300 X 380 X 1330 MM) ERGONOMIC ONE PIECE SHOVEL, LONG HANDLE (300 X 380 X 1330 MM)	6 /CAJA	POLIPROPILENO	

Cepillos detectables

Detectable brushes



70255-2



70548-2



70233-2



75063-2



72166-2

REF	DESCRIP			
70255-2	CEPILLO PANADERO METAL DETECTABLE FIBRA DURA AZUL (340 X 35 MM) STIFF METAL DETECTABLE BANISTER BRUSH BLUE (340 X 35 MM)	4 / CAJA	50 - PBT 0.60 DURO	●
70548-2	CEPILLO LIMPIA LECHERAS METAL DETECTABLE FIBRA.DURA AZUL (275 X 70 MM) STIFF METAL DETECTABLE CHURN BRUSH BLUE (275 X 70 MM)	6 / CAJA	50 - PBT 0.60 DURO	●
70233-2	CEP.MULTIUSOS CABEZAL ANCHO F.DURA METAL DETECTABLE AZUL (410 X 55 MM) STIFF METAL DETECTABLE LONG WIDE UTILITY BRUSH (410 X 55 MM)	10 / CAJA	60 - PBT 0.60 DURO	●
75063-2	CEPILLO MANO MULTIUSOS FIBRA DURA METAL DETECTABLE AZUL (210 X 70 MM) STIFF METAL DETECTABLE HAND SCRUB BRUSH BLUE (210 X 70 MM)	12 / CAJA	40 - PBT 0.60 DURO	●
72166-2	CEPILLO PARA HARINA FIBRA DURA METAL DETECTABLE AZUL (300 X 20 MM) STIFF METAL DETECTABLE FLOUR BRUSH BLUE (300 X 20 MM)	12 / CAJA	60 - PBT 0.60 DURO	●

Espátulas de plástico detectables

Plastic detectable spatulas



72904



75109

REF	DESCRIP			
72904	ESPÁTULA POLIPROPILENO METAL DETECTABLE Y RAYOS X (75 X 250 MM) POLYPROPYLENE METAL DETECTABLE & X-RAY SPATULA (75 X 250 MM)	12 /CAJA	METAL DETECTABLE Y RAYOS X	● ● ● ●
75109	ESPÁTULA POLIPROPILENO METAL DETECTABLE Y RAYOS X (110 X 250 MM) POLYPROPYLENE METAL DETECTABLE & X-RAY SPATULA (110 X 250 MM)	4 /CAJA	METAL DETECTABLE Y RAYOS X	● ● ● ●



Gama metal detectable

Fabricados con nuestro propio ingenio y con la utilización de aditivos aceptados en las normas Europeas de plásticos en contacto con los alimentos, este nuevo material permite que algún trozo de material que accidentalmente pueda romperse y pasar desapercibido a simple vista pueda ser identificado y rechazado por un equipo de detección de metales en línea. **Esta gama es apropiada y recomendada para industrias como la alimentaria y farmacéutica.**

Metal detectable articles

Manufactured from our own formulation involving additives that conform to food contact regulations, this addition allows material that may become accidentally detached from an article in use to be detected by standard in-line metal detection equipment. Appropriate for articles used in both the food and pharmaceutical manufacturing sectors.

Espátulas inox. mango detectable

Stainless steel spatulas with detectable hand grip



78042



78082



78102

REF	DESCRIP			
78042	ESPÁTULA INOX. RÍGIDA MANGO METAL DETECTABLE Y RAYOS X (40 X 240 MM) STIFF STAINLESS STEEL SPATULA WITH DETECTABLE HAND GRIP (40 X 240 MM)	12 / CAJA	METAL DETECTABLE Y RAYOS X DURO	
78082	ESPÁTULA INOX. RÍGIDA MANGO METAL DETECTABLE Y RAYOS X (80 X 240 MM) STIFF STAINLESS STEEL SPATULA WITH DETECTABLE HAND GRIP (80 X 240 MM)	12 / CAJA	METAL DETECTABLE Y RAYOS X DURO	
78102	ESPÁTULA INOX. RÍGIDA MANGO METAL DETECTABLE Y RAYOS X (120 X 240 MM) STIFF STAINLESS STEEL SPATULA WITH DETECTABLE HAND GRIP (120 X 240 MM)	12 / CAJA	METAL DETECTABLE Y RAYOS X DURO	

Espátulas ergonómicas detectables

Detectable ergonomic spatulas



71910



71911

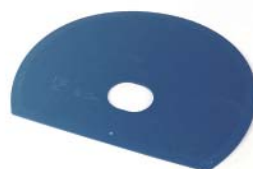

71915

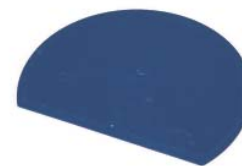

71916



71900



72900

REF	DESCRIP				
71910	ESPÁTULA FLEXIBLE DETECT.& RAYOS X CON AGUJERO (146 X 98 X 1,65 MM) FLEXIBLE METAL DETECT.& X-RAY SPATULA WITH HOLE (146 X 98 X 1,65 MM)	20 / CAJA	METAL DETECTABLE Y RAYOS X	UNICO	
71911	ESPÁTULA FLEXIBLE METAL DETECTABLE & RAYOS X (146 X 98 X 1,65 MM) FLEXIBLE METAL DETECTABLE & X- RAY SPATULA (146 X 98 X 1,65 MM)	20 / CAJA	METAL DETECTABLE Y RAYOS X	UNICO	
71915	ESPÁTULA FLEX. REDONDA M. DETECT. Y RAYOS X CON AGUJERO (160 X 125X 1,65 MM) ROUND FLEXIBLE MET.DETECT.& X-RAY SPATULA WITH HOLE (160 X 125X 1,65 MM)	20 / CAJA	METAL DETECTABLE Y RAYOS X	UNICO	
71916	ESPÁTULA FLEX.REDONDA METAL DETECT.Y RAYOS X (160 X 125 X 1,65 MM) ROUND FLEXIBLE METAL DETECT.& X-RAY SPATULA (160 X 125 X 1,65 MM)	20 / CAJA	METAL DETECTABLE Y RAYOS X	UNICO	
71900	RASQUETA ERGONÓMICA METAL DETECT. Y RAYOS X CON 3 LADOS OPERATIVOS (200 X 125 MM) METAL DETECT.& X-RAY SPATULA WITH 3 SCRAPE EDGES (200 X 125 MM)	12 / CAJA	METAL DETECTABLE Y RAYOS X	UNICO	
72900	RASQUETA ERGONÓMICA METAL DETECT.Y RAYOS X CON 2 LADOS OPERATIVOS (100 X 240 MM) METAL DETECT.& X-RAY SPATULA WITH 2 SCRAPE EDGES (100 X 240 MM)	12 / CAJA	METAL DETECTABLE Y RAYOS X	UNICO	

Cucharas de mano detectables

Detectable hand scoop



75105



75106



75107

REF	DESCRIP				
75105	PALA MANO 500 GRS METAL DETECTABLE Y RAYOS X (110 X 150 X 260 MM) METAL DETECTABLE & X-RAY HAND SCOOP 500 GRS (110 X 150 X 260 MM)	10 / CAJA	METAL DETECTABLE Y RAYOS X	UNICO	
75106	PALA MANO 750 GRS METAL DETECTABLE Y RAYOS X (135 X 185 X 310 MM) METAL DETECTABLE & X-RAY HAND SCOOP 750 GRS (135 X 185 X 310 MM)	10 / CAJA	METAL DETECTABLE Y RAYOS X	UNICO	
75107	PALA MANO 1000 GRS METAL DETETABLE Y RAYOS X (160 X 230 X 360 MM) METAL DETECTABLE & X-RAY HAND SCOOP 1000 GRS (160 X 230 X 360 MM)	10 / CAJA	METAL DETECTABLE Y RAYOS X	UNICO	

Palas de mano detectables

Detectable hand shovels



70305



70301

REF	DESCRIP				
70305	PALA MANO METAL DETECTABLE Y RAYOS X (270 X 320 X 540 MM) METAL DETECTABLE & X-RAY HAND SCOOP (270 X 320 X 540 MM)	6 / CAJA	METAL DETECTABLE Y RAYOS X	UNICO	
70301	PALA MANO EXTRA FUERTE METAL DETECTABLE Y RAYOS X (300 X 310 MM) VERY STRONG METAL DETECTABLE & X-RAY DUSTPAN (300 X 310 MM)	6 / CAJA	METAL DETECTABLE Y RAYOS X	UNICO	

Cubo 15l. y tapa detectable

15 l. detectable bucket and lid



70101









70111

REF	DESCRIP				
70101	CUBO ALIMENTARIO METAL DETECTABLE Y RAYOS X 15 LITROS METAL DETECTABLE & X-RAY BUCKET 15 LITRE	4 / CAJA	METAL DETECTABLE Y RAYOS X	UNICO	
70111	TAPA PARA CUBO ALIMENTARIO METAL DETECTABLE Y RAYOS X 15 LITROS LID FOR BUCKET METAL DETECTABLE & X-RAY 15 LITRE	4 / CAJA	METAL DETECTABLE Y RAYOS X	UNICO	

Palas de mano ergonómicas detectables

Detectable shovel



REF	DESCRIP				
74103	PALA MONOBLOQUE METAL DETECTABLE Y RAYOS X (270 X 340 X 1120 MM) METAL DETECTABLE & X-RAY ONE PIECE SHOVEL (270 X 340 X 1120 MM)	6 / CAJA	METAL DETECTABLE Y RAYOS X	UNICO	
74104	PALA MONOBLOQUE METAL DETECTABLE Y RAYOS X (330 X 380 X 1120 MM) METAL DETECTABLE & X-RAY ONE PIECE SHOVEL (330 X 380 X 1120 MM)	6 / CAJA	METAL DETECTABLE Y RAYOS X	UNICO	
75103	PALA MONOBLOQUE METAL DETECTABLE Y RAYOS X (270 X 340 X 1330 MM) METAL DETECTABLE & X-RAY ONE PIECE SHOVEL (270 X 340 X 1330 MM)	6 / CAJA	METAL DETECTABLE Y RAYOS X	UNICO	
75104	PALA MONOBLOQUE METAL DETECTABLE Y RAYOS X (330 X 380 X 1330 MM) METAL DETECTABLE & X-RAY ONE PIECE SHOVEL (330 X 380 X 1330 MM)	6 / CAJA	METAL DETECTABLE Y RAYOS X	UNICO	

Colgadores

Holders



15150



15151



80000

REF	DESCRIP			
15150	COLGADOR SUELTO PARA Ø 22 - 32 MM SINGLE CLIP FOR Ø 22 - 32 MM	12 /CAJA	UNICO	
15151	COLGADOR SUELTO PARA Ø 28 - 38 MM SINGLE CLIP FOR Ø 28 - 38 MM	12 /CAJA	UNICO	
80000	GANCHO COLGADOR REFORZADO CON FIBRA DE VIDRIO (60 MM) WALL HOOK STRENGTHEN WITH FIBREGLASS (60 MM)	12 /CAJA	UNICO	



80005

TOPE PLÁSTICO PARA RIEL ALUMINIO

REPLACEMENT END CAP FOR ALUMINIUM RAIL

12 /CAJA UNICO



15156



15154



80002

TABLA IDENTIFICATIVA PARA RAIL (110 X 75 MM)

SIGN BOARD FOR ALUMINIUM RAIL (110 X 75 MM)

12 /CAJA UNICO



15153

REF	DESCRIP			
15156	RIEL ALUMINIO DE 300 MM SINGLE ALUMINIUM RAIL 300 MM	10 /CAJA	UNICO	
15154	RIEL ALUMINIO DE 500 MM SINGLE ALUMINIUM RAIL 500 MM	10 /CAJA	UNICO	
15153	RIEL ALUMINIO DE 900 MM SINGLE ALUMINIUM RAIL 900 MM	10 /CAJA	UNICO	



Pistolas de agua extra resistentes Waterguns



0411

PISTOLA DE AGUA - ALTA RESISTENCIA - LATÓN

WATERGUN (HEAVY DUTY MODEL, BRASS)

 1 /CAJA

 UNICO



Acoples

Couplers



5370



5372



5373



5361



5355



5353



5350



5365



5354



5351

REF	DESCRIP			
5370	ACOPLE MANGUERA DE 1/2" HOSE NIPPLE WITH THREAD FOR GUN 1/2"	1 /CAJA	60CM	UNICO
5372	ACOPLE MANGUERA Y PISTOLA 1/2" NIPPEL WITH THREAD FOR GUN 1/2"	1 /CAJA	75CM	UNICO
5373	ACOPLE MANGUERA Y PISTOLA 3/4" NIPPEL WITH THREAD FOR GUN 3/4"	1 /CAJA	100CM	UNICO
5361	ACOPLE PARA GRIFO 1/2", 3/4" Y M2 TAP COUPLING 1/2", 3/4", M2	5 /CAJA	45CM	UNICO
5355	ACOPLE MANGUERA CON CABEZA + GRIFO 1/2" HOSE COUPLER WITH " SWIVLE HOSE TAIL AND STOP VALVE	5 /CAJA	60CM	UNICO
5353	ACOPLE PARA MANGUERA CON VALVULA RETENCIÓN 1/2" HOSE COUPLER WITH WATERSTOP 1/2"	5 /CAJA	75CM	UNICO
5350	ACOPLE MANGUERA DE 1/2" HOSE COUPLER 1/2"	10 /CAJA	100CM	UNICO
5365	CONECTOR ENTRE MANGUERAS 1/2" CONNECTOR 1/2"	10 /CAJA	140CM	UNICO
5354	ACOPLE MANGUERA 3/4" CON VALV. RETENCIÓN HOSE COUPLER WITH WATERSTOP 3/4"	5 /CAJA	140CM	UNICO
5351	ACOPLE PARA MANGUERA 3/4" HOSE COUPLER 3/4"	5 /CAJA	140CM	UNICO

DISCOS ABRASIVOS

ABRASIVE FLOOR PADS

PERFORMANCE AND EFFICIENCY



Discos abrasivos

Alta Calidad para conseguir los mejores resultados

Abrasive Pads

High quality for a better results.



Disco abrasivo negro

- » Agresividad alta.
- » Producto ideal para decapar el suelo antes de protegerlo con un tratamiento de acabado de superficie.
- » Ideal para eliminar capas de cera acumuladas.
- » Para uso en mojado ofrece una alta resistencia a los productos ácidos.
- » Usar a velocidad estándar.

Black abrasive floor pad

- » High Aggressiveness
- » Ideal for descaling floors
- » Ideal to eliminate wax layers
- » In wet use offers high resistance to acid products.
- » Use at standard speed.



Disco abrasivo marrón

- » Agresividad alta.
- » Producto recomendado para la limpieza a fondo de suelos antes de aplicar tratamiento protector.
- » Ideal para eliminar capas de cera acumuladas.
- » Para uso en mojado ofrece una alta resistencia a los productos ácidos.
- » Usar a velocidad estándar.

Brown abrasive floor pad

- » High aggressiveness
- » Ideal for floor deep cleaning before applying a protective surface treatment.
- » Ideal to eliminate wax layers.
- » In wet use offers high resistance to acid products.
- » Use at standard speed.

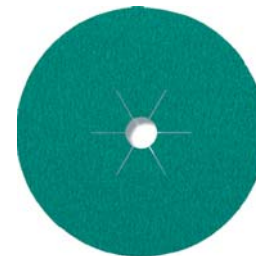

Disco abrasivo verde

- » Agresividad media.
- » Producto recomendado para fregado de suelos sin protección.
- » Para uso en mojado con velocidades estándar.

Green abrasive floor pad

- » Medium Aggressiveness
- » Recommended for unprotected floor cleaning.
- » For wet use at standard speed.



Disco abrasivo rojo

- » Agresividad baja.
- » Producto recomendado para acabado y mantenimiento rutinario de suelos sucios.
- » Diseñado para uso frecuente.
- » Usar a velocidad estándar.

Red abrasive floor pad

- » Low aggressiveness
- » Product recommended for dirty floors routine maintenance.
- » Designed for frequent use.
- » Use at standard speed.



Disco abrasivo azul

- » Agresividad baja.
- » Producto adecuado para la limpieza con Spray para eliminar marcas y manchas de suelos sucios.
- » También es posible emplearlo para dar brillo en suelos con una protección.
- » Usar a velocidad estándar.

Blue abrasive floor pad

- » Low aggressiveness
- » Product recommended for eliminating with spray spots or marks from dirty floors.
- » Recommended for polishing floors with protection.
- » Use at standard speed.



Disco abrasivo blanco

- » Sin fibras abrasivas.
- » Producto adecuado para pulir suelos.
- » Es recomendable su uso tras haber eliminado los restos de polvo.
- » Limpieza seca o húmeda.
- » Usar a velocidades estándar.

White abrasive floor pad

- » Without Abrasive Fibers
- » Recommended for polishing floors
- » Is recommended to use after cleaning the dust.
- » Can be used dry or wet.
- » Use at standard speed



22003







22004

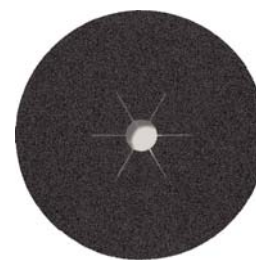

22005



22006

REF	DESCRIP				
22003	DISCO ABRASIVO 10 "/b>254 MM ABRASIVE FLOOR PAD 10 "/b>254 MM	5 /CAJA	10"	UNICO	N/A
22004	DISCO ABRASIVO 11 "/b>279 MM ABRASIVE FLOOR PAD 11 "/b>279 MM	5 /CAJA	11"	UNICO	N/A
22005	DISCO ABRASIVO 12 "/b>305 MM ABRASIVE FLOOR PAD 12 "/b>305 MM	5 /CAJA	12"	UNICO	N/A
22006	DISCO ABRASIVO 13 "/b>330 MM ABRASIVE FLOOR PAD 13 "/b>330 MM	5 /CAJA	13"	UNICO	N/A
22007	DISCO ABRASIVO 14"/b>356 MM ABRASIVE FLOOR PAD 14"/b>356 MM	5 /CAJA	14"	UNICO	N/A
22008	DISCO ABRASIVO 15 "/b>381 MM ABRASIVE FLOOR PAD 15 "/b>381 MM	5 /CAJA	15"	UNICO	N/A
22009	DISCO ABRASIVO 16 "/b>406 MM ABRASIVE FLOOR PAD 16 "/b>406 MM	5 /CAJA	16"	UNICO	N/A
22010	DISCO ABRASIVO 17 "/b>432 MM ABRASIVE FLOOR PAD 17 "/b>432 MM	5 /CAJA	17"	UNICO	N/A
22011	DISCO ABRASIVO 18 "/b>457 MM ABRASIVE FLOOR PAD 18 "/b>457 MM	5 /CAJA	18"	UNICO	N/A
22012	DISCO ABRASIVO 19 "/b>483 MM ABRASIVE FLOOR PAD 19 "/b>483 MM	5 /CAJA	19"	UNICO	N/A
22013	DISCO ABRASIVO 20 "/b>509 MM ABRASIVE FLOOR PAD 20 "/b>509 MM	5 /CAJA	20"	UNICO	N/A
22014	DISCO ABRASIVO 21 "/b>543 MM ABRASIVE FLOOR PAD 21 "/b>543 MM	5 /CAJA	21"	UNICO	N/A
22015	DISCO ABRASIVO 22 "/b>560 MM ABRASIVE FLOOR PAD 22 "/b>560 MM	5 /CAJA	22"	UNICO	N/A
22054	DISCO ABRASIVO 23"/b>584 MM ABRASIVE FLOOR PAD 23"/b>584 MM	5 /CAJA	23"	UNICO	N/A
22016	DISCO ABRASIVO 24"/b>610 MM ABRASIVE FLOOR PAD 24"/b>610 MM	5 /CAJA	24"	UNICO	N/A

* Si no encuentra la medida que necesita, contacte con nosotros para solicitar un plazo de entrega

* Si no encuentra la medida que necesita, contacte con nosotros para solicitar un plazo de entrega

Fibra abrasiva

Abrasive pads



22046



22047

REF	DESCRIP				
22046	ROLLO ABRASIVO VERDE (PACK 1 UD.) ABRASIVE GREEN PAD ROLL (PACK 1 PC.)	6 /CAJA	15 CM X 5 M.	UNICO	N/A
22047	ROLLO ABRASIVO BLANCO (PACK 1 UD.) ABRASIVE WHITE PAD ROLL (PACK 1 PC.)	6 /CAJA	16 CM X 5 M.	UNICO	N/A



22048



22049

REF	DESCRIP				
22048	FIBRA ABRASIVA VERDE (PACK 12 UDS) ABRASIVE GREEN PAD (PACK 12 PCS)	8 X 12 /CAJA	15 X 23 CM	UNICO	N/A
22049	FIBRA ABRASIVA BLANCA (PACK 12 UDS) ABRASIVE WHITE PAD (PACK 12 PCS)	8 X 12 /CAJA	16 X 23 CM	UNICO	N/A



22050



22051



REF	DESCRIP				
22050	SALVAUÑAS VERDE (PACK 6 UDS) SCOURING GREEN PAD (PACK 6 PCS)	10 X 6 /CAJA	15 X 6,8 CM	UNICO	N/A
22051	SALVAUÑAS BLANCO (PACK 6 UDS) SCOURING WHITE PAD (PACK 6 PCS)	10 X 6 /CAJA	15 X 6,8 CM	UNICO	N/A
22052	FIBRA VERDE + ESPONJA (PACK 12 UDS) SCOURING BROWN PAD (PACK 12 PCS)	5 X 12 /CAJA UNICO	14 X 9 CM N/A		

GAMA DE PRODUCTOS ANTIESTÁTICOS
ANTI-STATIC PRODUCT RANGE

ANTI-STATIC PRODUCT RANGE

Nuestra gama de productos Anti-estáticos para la limpieza es la más completa y eficiente del mercado profesional. Disponemos de un **amplio rango de herramientas diseñadas para limpiar en diferentes tipos ambientes con problemas de energía estática.**

Our Anti-static cleaning product range is the most complete and efficient in the professional market. We can supply a **wide range of tools designed for cleaning in different places that may have static electricity issues.**

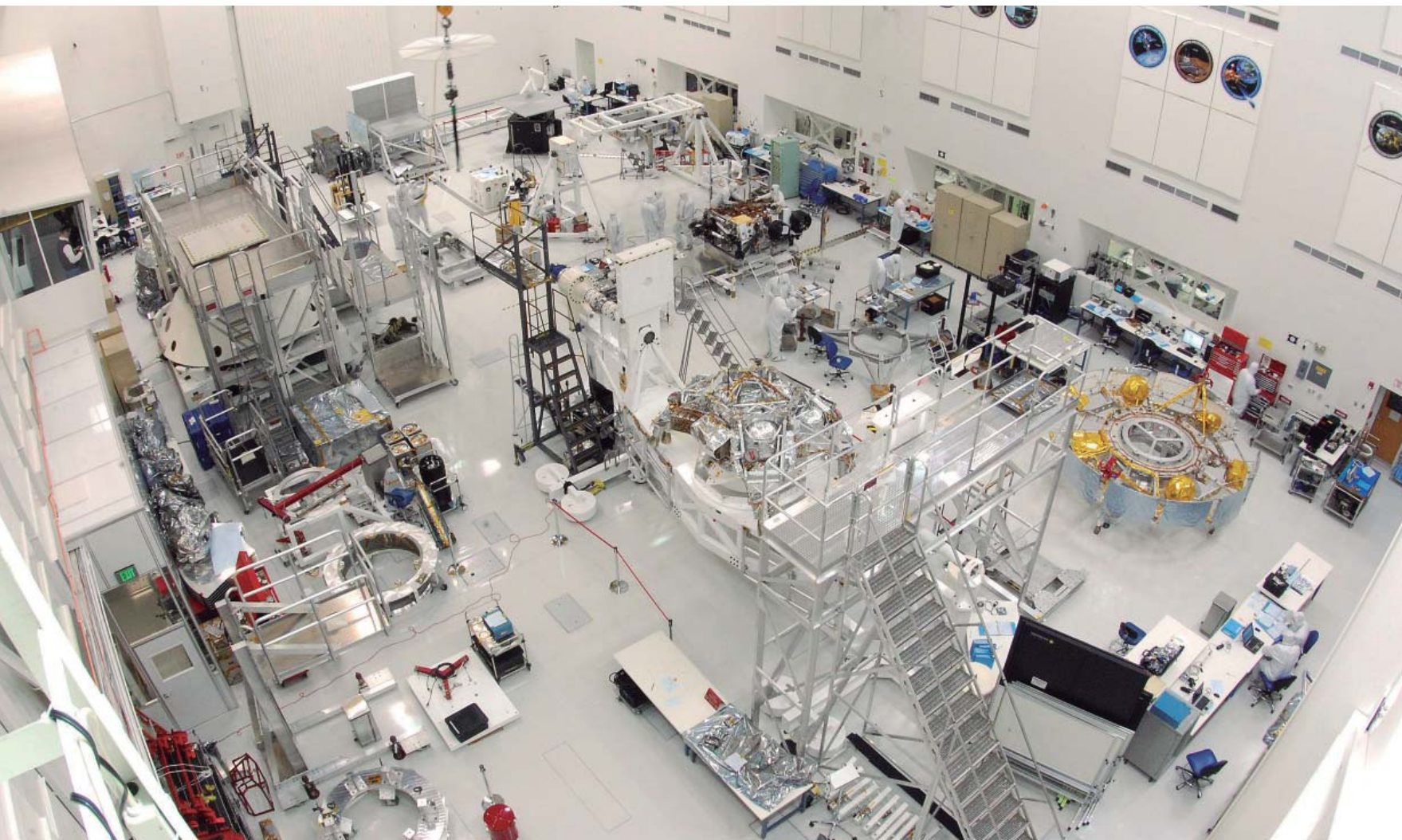

Anti-estático

Ideal para uso en lugares con indicios de carga estática peligrosa

Anti-static

Suitable for cleaning areas with possible electrostatic charge

El Rango de cepillos Anti-estáticos de Maya Professional Tools es ideal para uso en lugares de alto riesgo dónde cualquier indicio de carga estática es peligrosa, no deseable o podría provocar una explosión.

The anti-static range is ideal for use in high-risk environments where a build up of static charge presents an undesirable, hazardous or explosive potential.



Cualquier movimiento relativo, separación física de materiales o flujo de sólidos, líquidos o gases con partículas pueden generar una descarga electrostática. La directiva 99 / 92EC ATEX reconoce estas descargas como una fuente potencial de ignición en atmósferas explosivas asociadas con una amplia gama de industrias, en particular en los productos químicos, productos farmacéuticos, petróleo y procesamiento de alimentos.

Las fuentes más comunes de descarga electrostática incluyen: artículos hechos de materiales plásticos, equipos de procesamiento y personal. La acumulación de electricidad estática y la descarga puede dañar o destruir los componentes electrónicos sensibles, borrar o alterar los medios magnéticos o suponer un problema en el manejo de ciertos materiales.

Any relative motion and physical separation of materials or flow of solids, liquids or particle-laden gases can generate an electrostatic discharge. The '99/92EC ATEX Directive' recognizes these discharges as a potential source of ignition in explosive atmospheres associated with a range of industries, particularly within chemicals, pharmaceuticals, petroleum and food processing. Common sources of electrostatic discharge include; items made from plastic materials, processing equipment and personnel.

Such static build-up and discharge can damage or destroy sensitive electronic components, erase or alter magnetic media or make material handling problematic.

¿Cómo son los productos anti-estáticos?

Nuestro rango de productos anti-estáticos está fabricado a partir de un co-polímero de polipropileno con un aditivo especial para crear un material conductor con la capacidad para disipar fácilmente una carga estática antes de que pueda acumularse.

A diferencia de los productos de metal conectados a tierra comparativos, cada producto dentro de nuestro rango es ligero, prácticamente **irrompible, no se pudre ni se oxida y presenta una excelente resistencia al desgaste**.

Algunos de los sectores dónde se utilizan nuestros productos son:

- » Industria electrónica
- » Industria óptica
- » Industria farmacéutica
- » Empresas de elaboración de explosivos
- » Industrias alimentarias
- » Procesos de retractilado
- » Maquinarias de impresión

How are anti-static products?

Our products range is manufactured from a polypropylene co-polymer with a special additive to create a conductive material with the ability to readily dissipate a static charge before it can accumulate.

Unlike comparative earthed metal products, each product within our range is **lightweight, virtually unbreakable, will not rot or rust and exhibits excellent wear resistance**.

Some sectors where our products are used:

- » Electronics Industry
- » Optical Industry
- » Pharmaceutical Industry
- » Explosive Industry
- » Food Industry
- » Shrink process Industry
- » Printing Machines





C15105

C15106

C15107

REF	DESCRIP				
C15105	PALA DE MANO (110 X 150 X 265 MM) 500G HAND SCOOP (110 X 150 X 265 MM) 500G	10 /CAJA	N/A	UNICO	Negro antiestático
C15106	PALA DE MANO (135 X 185 X 310 MM) 750G HAND SCOOP (135 X 185 X 310 MM) 750G	10 /CAJA	N/A	UNICO	Negro antiestático
C15107	PALA DE MANO (160 X 230 X 360 MM) 1000G HAND SCOOP (160 X 230 X 360 MM) 1000g	10 /CAJA	N/A	UNICO	Negro antiestático



C15109



C82900



C82904

REF	DESCRIP				
C15109	ESPÁTULA PLÁSTICO (110 X 250 MM) SPATULA (110 X 250 MM)	12 /CAJA	N/A	UNICO	Negro antiestático
C82900	ESPÁTULA ERGONÓMICA CON 2 LADOS OPERATIVOS (100 X 240 MM) ERGO SPATULA WITH 2 WORKING SIDES (100 X 240 MM)	12 /CAJA	N/A	UNICO	Negro antiestático
C82904	ESPÁTULA PLÁSTICO (75 X 250 MM) SPATULA (75 X 250 MM)	12 /CAJA	N/A	UNICO	Negro antiestático



C81916



C81911

REF	DESCRIP				
C81916	RASQUETA FLEXIBLE REDONDA SIN AGUJERO (160 X 125 X 1,65 MM) ROUND FLEXIBLE SCRAPER WITHOUT HOLE (160 X 125 X 1,65 MM)	20 /CAJA	N/A	UNICO	Negro antiestático
C81911	RASQUETA FLEXIBLE PARA MASA SIN AGUJERO (146 X 98 X 1,65 MM) FLEXIBLE SCRAPER WITHOUT HOLE (146 X 98 X 1,65 MM)	20 /CAJA	N/A	UNICO	Negro antiestático



C80301

PALA DE MANO EXTRA FUERTE (300 X 310 MM)

STRONG DUSTPAN (300 X 310 MM)

6 /CAJA

N/A

ÚNICO

Negro antiestático



C21136



C25155



C26155

REF	DESCRIP				
C21136	CEPILLO BARRENDERO FIBRA SUAVE(400 X 60 MM) SWEEPER (400 X 50 MM)	6 /CAJA	N/A	UNICO	Negro antiestático
C25155	CEPILLO BARRENDERO FIBRA SEMIDURA (400 X 60 MM) MEDIUM BROOM (400 X 60 MM)	6 /CAJA	N/A	UNICO	Negro antiestático
C26155	CEPILLO BARRENDERO FIBRA SEMIDURA (500 X 600 MM) MEDIUM BROOM (500 X 60 MM)	6 /CAJA	N/A	UNICO	Negro antiestático



REF	DESCRIP				
C29903	MANGO DE UNA PIEZA ERGONÓMICO SUPER HIGIÉNICO (1300 X 32 MM) ONE PIECE ERGONOMIC HANDLE, SUPER HYGIENIC (1300 X 32 MM)	6 /CAJA	N/A	UNICO	Negro antiestático
C29904	MANGO DE UNA PIEZA ERGONÓMICO SUPER HIGIÉNICO (1500 X 32 MM) ONE PIECE ERGONOMIC HANDLE, SUPER HYGIENIC (1500 X 32 MM)	6 /CAJA	N/A	UNICO	Negro antiestático
C29905	MANGO DE UNA PIEZA ERGONÓMICO SUPER HIGIÉNICO (1700 X 32 MM) ONE PIECE ERGONOMIC HANDLE, SUPER HYGIENIC (1700 X 32 MM)	6 /CAJA	N/A	UNICO	Negro antiestático



C27134



C10546



C10252



C54134

REF	DESCRIP				
C27134	CEPILLO LIMPIA TANQUES FIBRA MEDIA (200 X 120 MM) MEDIUM TANK BRUSH (200 X 120 MM)	6 /CAJA	N/A	UNICO	Negro antiestático
C10546	CEPILLO DE MANO CON MANGO FIBRA SEMIDURA (275 X 70 MM) MEDIUM CHURN BRUSH (275 X 70 MM)	6 /CAJA	N/A	UNICO	Negro antiestático
C10252	CEPILLO PANADERO FIBRA SEMIDURA (340 X 35 MM) MEDIUM BANISTER BRUSH (340 X 35 MM)	10 /CAJA	N/A	UNICO	Negro antiestático
C54134	CEPILLO MANO REDONDO FIBRA SEMIDURA (Ø 125 MM) MEDIUM ROUND HAND SCRUB BRUSH (Ø 125 MM)	6 /CAJA	N/A	UNICO	Negro antiestático



C80101
CUBO 15 LITROS CON ASA

Bucket 15 litre

 6 /CAJA N/A ÚNICO Negro antiestático

C80111
TAPA CUBO 15 L.

Lid for Bucket

 6 /CAJA N/A ÚNICO Negro antiestático



C80205



C80201



C80200

REF	DESCRIP				
C80205	RECOGEDOR ABATIBLE DE MANO DUSTPAN WITH LID AND HANDGRIP	6 /CAJA	N/A	UNICO	Negro antiestático
C80201	RECOGEDOR ABATIBLE SIN PALO DUSPAN WITHOUT HANDLE	6 /CAJA	N/A	UNICO	Negro antiestático
C80200	RECOGEDOR ABATIBLE CON MANGO UNA PIEZA (330 X 310 X 125 MM) LONG HANDLE DUSTPAN WITH ONE PIECE HANDLE(300 X 310 X 125 MM)	6 /CAJA	N/A	UNICO	Negro antiestático



C29902

PALO DE UNA PIEZA ERGONÓMICO PARA RECOGEDOR (1000 X 32 MM)

ONE PIECE ERGONOMIC HANDLE FOR DUSTPAN, SUPER HYGIENIC (1000 X 32 MM)

 6 /CAJA N/A ÚNICO N/A



C24147



C27131

C27133



C50153



C15060



C10201



C27250

C27260

REF	DESCRIP				
C24147	CEPILLO DE BARRER SUAVE (280 X 48 MM) SOFT UPRIGHT SWEEPER (280 X 48 MM)	6 /CAJA	N/A	UNICO	Negro antiestático
C27131	CEPILLO LIMPIATUBERÍAS C/ACOPLE MANGO (Ø 70 X 95 X 120 MM) TUBE CLEANING BRUSH FOR HANDLE (Ø 70 X 95 X 120 MM)	6 /CAJA	N/A	UNICO	Negro antiestático
C27133	CEPILLO LIMPIATUBERÍAS C/ACOPLE MANGO (Ø 90 X 105 X 130 MM) TUBE CLEANING BRUSH FOR HANDLE (Ø 90 X 105 X 130 MM)	6 /CAJA	N/A	UNICO	Negro antiestático
C50153	CEPILLO ESTRECHO PARA MAQUINARIA (275 X 20 MM) STIFF SMALL MACHINE BRUSH (275 X 20 MM)	12 /CAJA	N/A	UNICO	Negro antiestático
C15060	CEPILLO UÑAS FIBRA INTERMEDIA (110 X 45 MM) MEDIUM NAIL BRUSH (110 X 45 MM)	12 /CAJA	N/A	UNICO	Negro antiestático
C10201	CEPILLO MULTIUSOS MANGO CORTO FIBRA SEMIDURA (270 X 47 MM) MEDIUM SMALL UTILITY BRUSH (270 X 47 MM)	12 /CAJA	N/A	UNICO	Negro antiestático
C27250	CEPILLO LIMPIATUBERÍAS EXTERIORES (Ø 50 MM) TUBE CLEANING BRUSH (Ø 50 MM)	1/CAJA	N/A	UNICO	Negro antiestático
C27260	CEPILLO LIMPIATUBERÍAS EXTERIORES (Ø 100 MM) TUBE CLEANING BRUSH (Ø 100 MM)	1/CAJA	N/A	UNICO	Negro antiestático



C10232



C52126



C57156



C15064



C10713



C10754

REF	DESCRIP				
C10232	CEPILLO MULTIUSOS CABEZAL ANCHO FIBRA SEMIDURA (410 X 55 MM) MEDIUM LONG WIDE UTILITY BRUSH (410 X 55 MM)	10 /CAJA	N/A	UNICO	Negro antiestático
C51126	CEPILLO PANADERO FIBRA MUY SUAVE (410 X 55 MM) VERY SOFT BREAD BRUSH (410 X 55 MM)	10 /CAJA	N/A	UNICO	Negro antiestático
C52126	CEPILLO RECTO FIBRA MUY SUAVE (300 X 20 MM) VERY SOFT STRAIGHT BRUSH (300 X 20 MM)	12 /CAJA	N/A	UNICO	Negro antiestático
C57156	CEPILLO LIMPIATUBERÍAS CON MANGO FIBRA DURA (Ø 63 X 80 X 370 MM) STIFF TUBE CLEANER (Ø 63 X 80 X 370 MM)	12 /CAJA	N/A	UNICO	Negro antiestático
C15064	CEPILLO MANO MULTIUSOS FIBRA SEMIDURA (210 X 70 MM) MEDIUM HAND SCRUB BRUSH (210 X 70 MM)	12 /CAJA	N/A	UNICO	Negro antiestático
C10713	LIMPIATUBOS (Ø 55 X 140 X 450 MM) TUBE BRUSH Ø 55 X 140 X 450 MM	12 /CAJA	N/A	UNICO	Negro antiestático
C10754	CEPILLO LIMPIA TUBOS FIBRA INTERMEDIA (Ø 30 X 150 X 500 MM) MEDIUM TUBE BRUSH (Ø 30 X 150 X 500 MM)	12 /CAJA	N/A	UNICO	Negro antiestático



C14103



C14104



C15103



C15104



C80305

REF	DESCRIP				
C14103	PALA MONOBLOQUE, MANGO CORTO (270 X 340 X 1120 MM) SHORT HANDLE ONE PIECE SHOVEL (270 X 340 X 1120 MM)	6 /CAJA	N/A	UNICO	Negro antiestático
C14104	PALA MONOBLOQUE, MANGO CORTO (330 X 380 X 1120 MM) SHORT HANDLE ONE PIECE SHOVEL (330 X 380 X 1120 MM)	6 /CAJA	N/A	UNICO	Negro antiestático
C15103	PALA MONOBLOQUE, MANGO LARGO (270 X 340 X 1330 MM) LONG HANDLE ONE PIECE SHOVEL (270 X 340 X 1330 MM)	6 /CAJA	N/A	UNICO	Negro antiestático
C15104	PALA MONOBLOQUE, MANGO LARGO (330 X 380 X 1330 MM) LONG HANDLE ONE PIECE SHOVEL (330 X 380 X 1330 MM)	6 /CAJA	N/A	UNICO	Negro antiestático
C80305	PALA DE MANO (270 X 320 X 540 MM) HAND SCOOP (270 X 320 X 540 MM)	6 /CAJA	N/A	UNICO	Negro antiestático

CÚTERS CERÁMICOS

CERAMIC BLADE CUTTERS

CERAMIC BLADES



El objetivo de Maya Professional Tools es ayudarte con unos resultados de corte y seguridad extraordinarios. Es por eso que todas nuestras herramientas de corte Slice™ mezclan diseño con funcionalidad y características de seguridad con visión de futuro.

Slice envuelve todo lo referido a **cortar de forma segura con mayor eficacia** que los cutters tradicionales. Las **hojas cerámicas están hechas con la más alta tecnología utilizando Óxido de Zirconio** que es conocido por su dureza y durabilidad.

Made from high-tech Zirconium Oxide, Slice ceramic blades are known for their hardness and durability.

They last up to 10x longer than steel, and thanks to our unique manufacturing and sharpening process, they're safer to hold and use compared to traditional metal blades.



Tecnología Slice ceramic

Reduce lesiones | ahorra dinero

Slice ceramic technology

Reduce injuries | save money

- » Más fácil y seguro que el metal
 - » Fuerte y duradero
 - » Más seguro gracias a las esquinas redondeadas
 - » Doble cara
 - » La lámina de Slice es equivalente a 20 láminas de una cara de metal
 - » Fabricado con Oxido de Zirconio (ZrO₂). Sólo el diamante es más fuerte.
-
- » Easier & safer to handle vs. metal
 - » Strong and durable
 - » Safer rounded edges
 - » Double sided
 - » Single Slice ceramic blade is equivalent to up to 20 single-edge metal blades
 - » Made from pure Zirconium Oxide ZrO₂. Only diamonds are harder



Características

Characteristics

- » **Dureza y afilado:** las hojas de cerámica se clasifican en la escala de dureza de Mohs en 8.2 (sólo dos puntos por debajo del diamante) que en comparación con las hojas de metal que se clasifican en dicha escala en 5.5 aportan una dureza y afilado mucho mayor. Aristas más duras significan bordes más afilados que mantienen el afilado más duradero, **cortan mejor y requieren una frecuencia de afilado mucho menor.**
- » **Higiene:** el oxido de Zirconio es químicamente inerte, no poroso, antiadherente y resistente a los ácidos, sal y óxido. Químicamente inerte significa que **no hay impacto en el sabor de los alimentos**, así como la defensa contra las bacterias dañinas.
- » **Seguridad:** algunos de los muchos beneficios de la cerámica que disfrutan los usuarios del sector industrial incluyen:
 - » Bajas tasas de desgaste
 - » No magnético
 - » Antiestático
 - » Capaz de operar en altas temperaturas
 - » No se oxidan
- » **Diseño:** y por supuesto la ventaja de las herramientas de corte de cerámica Slice son los únicos diseños patentados que ofrecen a los usuarios del sector industrial una amplia gama de opciones para satisfacer sus necesidades de corte.

- » **Hardness and Sharpness :** Metal blades are rated 5.5 on the Mohs hardness scale compared to Slice ceramic blades at 8.2, second only to diamonds. Harder edges maintain sharpness longer, cut better, and require replacement far less frequently. In fact, depending on use, you can go weeks or months without having to replace a Slice ceramic blade. **Slice ceramic blades last up to 10x longer vs. traditional metal blades.**
- » **Hygiene :** Zirconium Oxide, the key material in Slice ceramics, is chemically inert, non-porous, non-stick and impervious to acids, salt, and rust. Chemically inert means **no impact or reaction with what you're cutting**, as well as a strong defense against harmful bacteria.
- » **Safety :** Some of the many benefits of Slice ceramic blades include:
 - » Safer to hold & use vs. traditional metal.
 - » low wear rates, lasts up to 10x longer vs. steel.
 - » Non-magnetic & anti-static.
 - » Non-conductive & non-sparking.
 - » Able to operate in high temperatures.
 - » Rust-proof, chemically inert & non-porous.
- » **Design :** And of course the added benefit of Slice ceramic cutting tools are the unique, patented handle designs that offer users a wide range of choices to meet your cutting needs. Have a specific cutting application? Let us know and we'll design something just for you.



C121



C122



C165



C126



C166



C124



C125

REF	DESCRIP				
C121	CUTTER DE SEGURIDAD PEQUEÑO CERÁMICO SLICE CERAMIC SAFETY CUTTER	24 /CAJA	N/A	UNICO	N/A
C122	CUTTER DE PRECISIÓN CERÁMICO SLICE CERAMIC PRECISION CUTTER	24 /CAJA	N/A	UNICO	N/A
C165	CUTTER CERÁMICO "MINI" AUTORETRACTIL CERAMIC MINI AUTO-RETRACTABLE CUTTER	12 /CAJA	N/A	UNICO	N/A
C126	CUTTER LÁPIZ CERÁMICO AUTO-RETRÁCTIL SLICE CERAMIC AUTO-RETRACTABLE PEN CUTTER	6 /CAJA	N/A	UNICO	N/A
C166	CUTTER LÁPIZ CERÁMICO NO RETRÁCTIL SLICE CERAMIC MANUAL PEN CUTTER	6 /CAJA	N/A	UNICO	N/A
C124	CUTTER "BOX" CERÁMICO SLICE CERAMIC MANUAL 3 POSITION BOX CUTTER	6 /CAJA	N/A	UNICO	N/A
C125	CUTTER "BOX" CERÁMICO AUTO-RETRÁCTIL SLICE CERAMIC AUTO-RETRACTABLE BOX CUTTER	6 /CAJA	N/A	UNICO	N/A



6111

PACK 4 HOJAS DE RECAMBIO PARA CUTTER "BOX" SLICE EN BLISTER

PACK 4 BOX CUTTER CERAMIC BLADES

-  6 PACKS /CAJA  N/A
-  ÚNICO  N/A

SC10420

TIJERAS ACERO INOXIDABLE SLICE

STAINLESS STEEL SCISSORS

-  6 /CAJA  N/A
-  ÚNICO  N/A



C127



C128



C129



C130





REF	DESCRIP				
C127	PINZAS COMBO ANTIDESLIZANTES ROJAS COMBO TIP SOFT TOUCH TWEEZERS	6 /CAJA	N/A	UNICO	N/A
C128	PINZAS COMBO INOX GRISES COMBO TIP STAINLESS TWEEZERS	6 /CAJA	N/A	UNICO	N/A
C129	PINZAS EN PUNTA ANTIDESLIZANTES ROJAS POINTED SOFT TOUCH TWEEZERS	6 /CAJA	N/A	UNICO	N/A
C130	PINZAS EN PUNTA INOX GRISES POINTED STAINLESS STEEL TWEEZERS	6 /CAJA	N/A	UNICO	N/A



C131



C132

REF	DESCRIP				
C131	TIJERAS DE PRECISIÓN CON HOJAS FINAS NARROW PRECISION SCISSORS	6 /CAJA	N/A	UNICO	N/A
C132	TIJERAS DE PRECISIÓN CON HOJAS ANCHAS WIDE PRECISION SCISSORS	6 /CAJA	N/A	UNICO	N/A



ÍNDICE DE PRODUCTOS
PRODUCTS INDEX

1043	Pack 25 cuchillas carbón para rascador pro + con dispensador	112	2007	Rascador de suelos 10 cm ancho con mango de 135 cm	113
1044	Rascador pro + 15 cm completo	112	2021	Empuñadura pro + enganche rápido	107
1045	Pack 10 cuchillas inox para rascador pro + 15 cm con dispensador	112	2044	Cinturón para porta utensilios	115
1127	Varilla con goma latón + clips laterales 25 cm	109	4010	Soporte "t" plástico pro grip 25 cm	110
1131	Varilla con goma latón + clips laterales 30 cm	109	4014	Soporte "t" plástico pro grip 35 cm	110
1135	Varilla con goma latón + clips laterales 35 cm	109	4018	SOPORTE "T" PLÁSTICO PRO GRIP 45 CM	110
1140	Varilla con goma latón + clips laterales 40 cm	109	4286	RASCADOR DE SEGURIDAD DE BOLSILLO	113
1144	Varilla con goma latón + clips laterales 45 cm	109	4310	Soporte "t" con barra aluminio pro + 25 cm	110
1152	Varilla con goma latón + clips laterales 55 cm	109	4314	Soporte "t" con barra aluminio pro + 35 cm	110
1225	Varilla con goma inox sin clips laterales 25 cm	107	4318	Soporte "t" con barra aluminio pro + 45 cm	110
1225	Varilla con goma inox sin clips laterales 25 cm	108	4515	Pack 100 cuchillas para rascador seguridad bolsillo	113
1229	Varilla con goma inox sin clips laterales 25 cm	107	4988	Goma master ettore 60 cm	111
1229	Varilla con goma inox sin clips laterales 25 cm	108	4989	Goma master ettore 75 cm	111
1233	Varilla con goma inox sin clips laterales 35 cm	107	5001	Haragán metálico 45 cm eco	120
1233	Varilla con goma inox sin clips laterales 35 cm	108	5002	Haragán metálico 60 cm eco	120
1237	Varilla con goma inox sin clips laterales 40 cm	107	5003	Haragán metálico 75 cm eco	120
1237	Varilla con goma inox sin clips laterales 40 cm	108	5350	Acople manguera de 1/2"	161
1241	Varilla con goma inox sin clips laterales 45 cm	107	5351	Acople para manguera 3/4"	161
1241	Varilla con goma inox sin clips laterales 45 cm	108	5353	Acople para manguera con valvula retención 1/2"	161
1248	Varilla con goma inox sin clips laterales 55 cm	107	5354	Acople manguera 3/4" con valv. Retención	161
1248	Varilla con goma inox sin clips laterales 55 cm	108	5355	Acople manguera con cabeza + grifo 1/2"	161
1253	Clips laterales para varillas latón	109	5361	Acople para grifo 1/2",3/4" y m2	161
1324	Empuñadura clásica latón	109	5365	Conector entre mangueras 1/2"	161
1329	Empuñadura acero inoxidable	108	5370	Acople manguera de 1/2"	161
1339	Empuñadura latón con goma + enganche rápido	109	5372	Acople manguera y pistola 1/2"	161
1339	Varilla con goma latón + clips laterales 55 cm	109	5373	Acople manguera y pistola 3/4"	161
1351	Empuñadura acero inoxidable con goma antiresbalo	108	6111	Pack 4 hojas de recambio para cutter "box" slice en blister	179
1352	Empuñadura acero inoxidable con enganche rápido	108	10201	Cepillo multiusos mango corto fibra semidura (270 x 47 mm)	137
1360	Maneta pro + enganche rápido giratoria	107	10203	Cepillo multiusos mango corto fibra dura (270 x 47 mm)	137
1360	Empuñadura giratoria sistema super	108	10215	Cepillo multiusos mango largo fibra dura (410 x 45 mm)	139
1407	Goma master ettore 25 cm	111	10232	Cepillo multiusos cabezal ancho fibra semidura (410 x 55 mm)	139
1408	Goma master pack 144 uds. 25 Cm	111	10233	Cepillo multiusos cabezal ancho fibra semidura (410 x 55 mm)	139
1412	Goma master ettore 30 cm	111	10252	Cepillo panadero fibra semidura (340 x 35 mm)	137
1413	Goma master pack 144 uds. 30 Cm	111	10254	Cepillo panadero fibra muy suave (340 x 35 mm)	137
1417	Goma master ettore 35 cm	111	10256	Cepillo panadero fibra semidura (2 tipos fibra 340 x 35 mm)	137
1418	Goma master pack 144 uds. 35 Cm	111	10463	Cepillo limpia platos fibra semidura con raspador (255 x 28 mm)	142
1422	Goma master ettore 40 cm	111	10466	Cepillo limpia platos fibra semidura (225 x 35 mm)	142
1427	Goma master ettore 45 cm	111	10546	Cepillo limpia lechera fibra semidura (275 x 70 mm)	138
1428	Goma master pack 144 uds. 45 Cm	111	10548	Cepillo limpia lechera fibra dura (275 x 70 mm)	138
1432	Goma master ettore 50 cm	111	10750	Cepillo limpia tubos fibra intermedia (ø 10 x 150 x 500 mm)	144
1438	Goma master ettore 55 cm	111	10752	Cepillo limpia tubos fibra intermedia (ø 20 x 150 x 500 mm)	144
1443	Goma master ettore 90 cm	111	10754	Cepillo limpia tubos fibra intermedia (ø 30 x 150 x 500 mm)	144
1444	Goma master pack 144 uds. 90 Cm	111	10756	Cepillo limpia tubos fibra intermedia (ø 40 x 150 x 500 mm)	144
1614	Soporte "t" con barra aluminio pro + 35 cm giratorio	110	10758	Cepillo limpia tubos fibra intermedia (ø 50 x 150 x 500 mm)	144
1618	Soporte "t" con barra aluminio pro + 45 cm giratorio	110	10759	Cepillo limpia tubos fibra intermedia (ø 60 x 150 x 500 mm)	144
1633	Haragán metálico 45 cm	120	10771	Cepillo limpia tubería para enroscar a cable (ø 12 x 100 x 160 mm)	145
1636	Haragán metálico 60 cm	120	10772	Cepillo limpia tubería para enroscar a cable (ø 20 x 100 x 160 mm)	145
1640	Maneta pro + enganche rápido giratoria	109	10774	Cepillo limpia tubería para enroscar a cable (ø 40 x 100 x 160 mm)	145
1680	Palo extensible 3 secciones 2,7 m. (3 X 90 cm) reach	117	10775	Cepillo limpia tubería para enroscar a cable (ø 50 x 100 x 160 mm)	145
1684	Palo extensible 3 secciones 3,6 m. (3 X 120 cm) reach	117	10776	Cepillo limpia tubería para enroscar a cable (ø 60 x 100 x 160 mm)	145
1688	Palo extensible 3 secciones 4,5 m. (3 X 150 cm) reach	117	10778	Cepillo limpia tubería para enroscar a cable (ø 80 x 100 x 160 mm)	145
1692	PALO EXTENSIBLE 3 SECCIONES 5,4 M. (3 X 180 CM) REACH	117	10780	Mango flexible acero inoxidable (150 cm)	145
1700	Enganche rápido para palo extensible gama pro +	118	10781	Mango flexible acero inoxidable (300 cm)	145
1957	SOPORTE "T" PLÁSTICO ESTÁNDAR 25 CM	110	10784	Cable nylon (150 cm)	145
1959	Soporte "t" plástico estándar 35 cm	110	10785	Cable extensión nylon (150 cm)	145
1961	Soporte "t" plástico estándar 45 cm	110	14103	Pala monobloque, mango corto (270 x 340 x 1120 mm)	153

14104	Pala monobloque, mango corto (330 x 380 x 1120 mm)	153	22003	Disco abrasivo 10"/254 mm	164
15001	Cepillo buque (280 x 50 mm)	124	22004	Disco abrasivo 11"/279 mm	164
15002	Cepillo buque (400 x 50 mm)	125	22005	Disco abrasivo 12"/305 mm	164
15003	Cepillo con fibras despuntadas (600 x 60 mm)	126	22006	Disco abrasivo 13"/330 mm	164
15004	Cepillo con fibras despuntadas (400 x 50 mm)	126	22007	Disco abrasivo 14"/356 mm	164
15007	Cep. Barrendero fibra dura (300 x 60 mm)	128	22008	Disco abrasivo 15"/381 mm	164
15008	Cep. Barrendero fibra dura (400 x 60 mm)	128	22009	Disco abrasivo 16"/406 mm	164
15009	Cepillo barrendero fibra semidura (400 x 60 mm)	128	22010	Disco abrasivo 17"/432 mm	164
15010	Cep. Barrendero fibra dura (500 x 60 mm)	128	22011	Disco abrasivo 18"/457 mm	164
15011	Cepillo para fregar fibra suave despuntada (225 x 60 mm)	129	22012	Disco abrasivo 19"/483 mm	164
15012	Cepillo para fregar fibra media (225 x 60 mm)	129	22013	Disco abrasivo 20"/509 mm	164
15023	Escoba fibra media suave (300 x 60 mm)	128	22014	Disco abrasivo 21"/543 mm	164
15025	Cepillo limpia tanques fibra media (200 x 120 mm)	130	22015	Disco abrasivo 22"/560 mm	164
15026	Cepillo limpia tanque fibra dura (200 x 120 mm)	130	22016	Disco abrasivo 24"/610 mm	164
15032	Mango aluminio con maneta (1500 x 25 mm)	135	22046	Rollo abrasivo verde (pack 1 ud.)	165
15033	Mango aluminio con maneta (1750 x 25 mm)	135	22047	Rollo abrasivo blanco (pack 1 ud.)	165
15037	Mango telescópico fibra vidrio con maneta (1500 -> 2800 x 26 mm)	135	22048	Fibra abrasiva verde (pack 12 uds)	165
15045	Mango telescópico fibra vidrio con maneta (1500 -> 2800 x 26 mm)	135	22049	Fibra abrasiva blanca (pack 12 uds)	165
15060	Limpiacristales reversible + palo extensible + caja expositora desmontada	106	22050	Salvauñas verde (pack 6 uds)	165
15060	Cepillo uñas fibra intermedia (110 x 45 mm)	142	22051	Salvauñas blanco (pack 6 uds)	165
15061	Cepillo uñas fibra dura (110 x 45 mm)	142	22052	Fibra verde + esponja (pack 12 uds)	165
15063	Cepillo mano multiusos fibra dura (210 x 70 mm)	141	22054	Disco abrasivo 23"/584 mm	164
15064	Cepillo mano multiusos fibra semidura (210 x 70 mm)	141	28243	Haragán de mano una pieza super higiénico con mango (300 mm)	133
15072	Haragán con recambio, goma blanca (500 mm)	133	30500	Jabón para limpieza cristales específico	105
15074	Haragán con recambio, goma blanca (700 mm)	133	33002	Pala plegable aluminio pintada	35
15076	Recambio haragán (500 mm)	133	33003	Expositor pala plegable	35
15078	Recambio haragán (700 mm)	133	40010	Vellon lavavidrios microfibra 25 cm	114
15103	Pala monobloque, mango largo (270 x 340 x 1330 mm)	153	40014	Vellon lavavidrios microfibra 35 cm	114
15104	Pala monobloque, mango largo (300 x 380 x 1330 mm)	153	40018	Vellon lavavidrios microfibra 45 cm	114
15105	Pala de mano (110 x 150 x 265 mm) 500 gram	151	40105	Cepillo con fibras suaves laterales despuntadas (290 x 130 mm)	129
15106	Pala de mano (135 x 185 x 310 mm) 750 gram	151	40154	Cep. De buque con fibras laterales (285 x 120 mm)	124
15107	Pala de mano (160 x 230 x 360 mm) 1000 gram	151	40155	Cep. Para frotar "angular" (285 x 130 mm)	124
15109	Espátula plástico (110 x 250 mm)	149	40157	Cepillo estrecho fibra semidura (260 x 35 mm)	127
15121	Fibra abrasiva suave beige (250 x 120 x 25 mm)	131	40190	Cepillo estrecho fibra dura (260 x 35 mm)	127
15121	Fibra abrasiva suave (250 x 120 x 25 mm)	147	42003	Palo extensible 2 secciones 60 cm. Interlock	117
15122	Fibra abravisa intermedia (250 x 120 x 25 mm)	131	42104	Palo extensible 2 secciones 1,2 m. (2 X 60 cm) reach	117
15122	Fibra abravisa intermedia (250 x 120 x 25 mm)	147	42108	Palo extensible 2 secciones 2,4 m. (2 X 120 cm) reach	117
15123	Fibra abrasiva muy suave (250 x 120 x 25 mm)	131	42112	Palo extensible 2 secciones 3,6 m. (2 X 180 cm) reach	117
15123	Fibra abrasiva muy suave (250 x 120 x 25 mm)	147	43009	Palo extensible 2,4 m. Total en 3 secciones	106
15124	Fibra abrasiva dura (250 x 120 x 25 mm)	131	43009	Palo extensible 3 secciones 2,4 m. 3 Secciones	118
15124	Fibra abrasiva dura (250 x 120 x 25 mm)	147	43012	Palo extensible 3,6 m. Total en 3 secciones	106
15125	Fibra abrasiva muy dura (250 x 120 x 25 mm)	131	43012	Palo extensible 3 secciones 3,6 m. 3 Secciones	118
15125	Fibra abrasiva muy dura (250 x 120 x 25 mm)	147	43153	Cepillo buque (300 x 60 mm)	124
15150	Colgador suelto para ø 22 - 32 mm	159	44104	Cepillo fregar fibra suave despuntada con paso de agua (265 x 90 mm)	129
15151	Colgador suelto para ø 28 - 38 mm	159	44112	Palo extensible 4 secciones 3,6 m. Interlock	118
15153	Riel aluminio de 900 mm	159	44118	Palo extensible 4 secciones 5,4 m. Interlock	118
15154	Riel aluminio de 500 mm	159	44124	Palo extensible 4 secciones 7,3 m. Interlock	118
15156	Riel aluminio de 300 mm	159	44132	Palo extensible 4 secciones 9,7 m. Interlock	118
15158	Set colgador duplo	27	44144	CEPILLO FREGAR FIBAR MEDIA CON PASO AGUA (265 X 90 MM)	129
15203	Cepillo fibra no despuntada (280 x 50 mm)	126	44147	CEPILLO DE BARRER SUAVE (280 X 48 MM)	127
15204	Cepillo fibra no despuntada (400 x 50 mm)	126	44157	Cepillo con fibras despuntadas (400 x 50 mm)	127
17012	Limpiacristales básico	104	46312	Rascador "champion" 13 cm completo	113
17050	Kit limpieza limpiacristales + vellón + palo extensible 1,5 m.	104	46322	Pack 10 cuchillas para rascador champion	113
20291	Pack 10 cuchillas para rascador de suelo 10 cm. Ancho	113	47101	Portafibras para mango (230 x 100 mm)	131
21014	Goma esp 35 cm	111	47106	Cepillo con fibras despuntadas (600 x 60 mm)	126
21018	Goma esp 45 cm	111	47121	Cepillo limpiatuberías c/acople mango (ø 63 x 95 x 120 mm)	130

47131	Cepillo limpiatuberías c/acople mango (ø 70 x 95 x 120 mm)	130	57159	Cepillo limpia tuberías con mango fibra dura (ø 90 x 80 x 370 mm)	146
47132	Cepillo limpiatuberías c/acople mango (ø 80 x 100 x 125 mm)	130	58014	Vellón lavavidrios abrasivo 35 cm	114
47133	Cepillo limpiatuberías c/acople mango (ø 90 x 105 x 130 mm)	130	58018	Vellón lavavidrios abrasivo 45 cm	114
47136	Cepillo fibra no despuntada (600 x 60 mm)	126	59017	Limpiacristales para vehiculos	105
47152	Cepillo limpiatuberías c/acople mango (ø 105 x 115 x 140 mm)	130	60012	Limpiacristales pro	104
47153	Cepillo limpiatuberías c/acople mango (ø 120 x 120 x 145 mm)	130	60014	Limpiacristales pro	104
47156	Cepillo barrendero fibra semidura (600 x 600 mm)	128	62010	Vellón recambio	105
47260	Cepillo limpiatuberías exterior (ø 100 x 340 x 600 mm)	131	62014	Vellón recambio	105
48100	Plumero de plumas	119	63010	Vellón lavavidrios pro	104
48120	Plumero estático	119	63014	Vellón lavavidrios pro	104
48281	Rasqueta acero inoxidable para mango	131	65000	Kit combo pro grip con lavavidrios y limpiacristales	104
48300	Haragán una pieza super higiénico (300 mm)	132	65004	Palo fijo 1,2 m. Aluminio con enganche rápido	106
48400	Haragán una pieza super higiénico (400 mm)	132	65004	Palo fijo 1,2 m. Aluminio con enganche rápido	118
48500	Haragán una pieza super higiénico (500 mm)	132	70101	Cubo alimentario metal detectable y rayos x 15 litros	158
48600	Haragán una pieza super higiénico (600 mm)	132	70111	Tapa para cubo alimentario metal detectable y rayos x 15 litros	158
48700	Haragán una pieza super higiénico (700 mm)	132	70301	Pala mano extra fuerte metal detectable y rayos x (300 x 310 mm)	157
49016	Agarrador de objetos 41 cm	115	70305	Pala mano metal detectable y rayos x (270 x 320 x 540 mm)	157
49036	Agarrador de objetos 81 cm	115	71101	Backflip reversible 25 cm inox	112
49105	Cep. Fregar ovalado con paso de agua fibra suave despuntadas	129	71141	Backflip reversible 35 cm inox	112
49154	Cep. Buque con paso de agua (285 x 120 mm)	124	71181	Backflip reversible 45 cm inox	112
49801	Mango aluminio con maneta (300 x 25 mm)	135	71900	Rasqueta ergonómica metal detect. rayos x con (200 x 125 mm)	156
49803	Mango aluminio con maneta (1300 x 25 mm)	135	71910	Espátula flexible detect.& Rayos x con agujero (146 x 98 x 1,65 mm)	156
49812	Mango ergonómico aluminio (650 x 32 mm)	134	71911	Espátula flexible metal detectable & rayos x (146 x 98 x 1,65 mm)	156
49813	Mango ergonómico aluminio (1300 x 32 mm)	134	71915	Espátula flex. Redonda m. Detect. Rayos x (160 x 125x 1,65 mm)	156
49824	Mango aluminio ergonómico con paso agua (1500 x 32 mm)	136	71916	Espátula flex.Redonda metal detect.Y rayos x (160 x 125 x 1,65 mm)	156
49826	Mango telescópico ergonómico con paso de agua (1750->3000 x 32 mm)	136	72900	Rasqueta ergonómica metal detect.Y rayos x (100 x 240 mm)	156
49856	Mango telescópico ergonómico de aluminio (1750->3000 x 32 mm)	135	72904	Espátula polipropileno metal detectable y rayos x (75 x 250 mm)	154
49903	Mango de una pieza ergonómico super higiénico (1300 x 32 mm)	134	74103	Pala monobloque metal detectable y rayos x (270 x 340 x 1120 mm)	158
49904	Mango de una pieza ergonómico super higiénico (1500 x 32 mm)	134	74104	Pala monobloque metal detectable y rayos x (330 x 380 x 1120 mm)	158
49905	Mango de una pieza ergonómico super higiénico (1700 x 32 mm)	134	75103	Pala monobloque metal detectable y rayos x (270 x 340 x 1330 mm)	158
50135	Bolsa porta-utensilios	115	75104	Pala monobloque metal detectable y rayos x (330 x 380 x 1330 mm)	158
50153	Cepillo estrecho para maquinaria o pescado(275 x 20 mm)	142	75105	Pala mano 500 grs metal detectable y rayos x (110 x 150 x 260 mm)	157
50155	Cepillo limpia cuchillas fibra dura (510 x ø 100 mm)	147	75106	Pala mano 750 grs metal detectable y rayos x (135 x 185 x 310 mm)	157
50321	Mango ergonómico aluminio (1500 x 32 mm)	134	75107	Pala mano 1000 grs metal detetable y rayos x (160 x 230 x 360 mm)	157
50331	Mango ergonómico aluminio (1750 x 32 mm)	134	75109	Espátula polipropileno metal detectable y rayos x (110 x 250 mm)	154
51010	Vellón lavavidrios amarillo 25 cm	114	78042	Esp. inox. Rígida mango metal detectable y rayos x (40 x 240 mm)	155
51014	Vellón lavavidrios amarillo 35 cm	114	78082	Esp. inox. Rígida mango metal detectable y rayos x (80 x 240 mm)	155
51018	Vellón lavavidrios amarillo 45 cm	114	78102	Esp. inox. Rígida mango metal detectable y rayos x (120 x 240 mm)	155
51126	Cepillo panadero fibra muy suave (410 x 55 mm)	143	80000	Gancho colgador reforzado con fibra de vidrio (60 mm)	159
52126	Cepillo para harina fibra muy suave (300 x 20 mm)	143	80002	Tabla identificativa para rail (110 x 75 mm)	159
52154	Cep. mano borde goma paso agua/acople fibra dura (300 x 75 mm)	140	80005	Tope plástico para riel aluminio	159
54134	Cepillo mano redondo fibra semidura (ø 125 mm)	141	80101	Cubo alimentaria 15 litros	152
54153	Cepillo mano fibra dura (210 x 65 mm)	141	80111	Tapa cubo alimentaria	152
54154	Cepillo mano redondo fibra dura (ø 125 mm)	141	80125	Cepillo para pastelería fibra suave (30 mm)	143
55010	Vellón lavavidrios básico	104	80200	Recogedor abatible con mango aluminio (330 x 310 x 125 mm)	151
55018	Haragán aluminio con goma recambio 45 cm	121	80201	Precogedor abatible sin mango (330 x 310 x 125 mm)	151
55024	Haragán aluminio con goma recambio 60 cm	121	80203	Recogedor abatible con mango aluminio (330 x 310 x 125 mm)	151
55030	Haragán aluminio con goma recambio 75 cm	121	80205	Recogedor de mano	152
55036	Haragán aluminio con goma recambio 90 cm	121	80301	Pala de mano extra fuerte (300 x 310 mm)	153
56018	Goma recambio haragán aluminio 45 cm	121	80305	Pala de mano (270 x 320 x 540 mm)	153
56024	Goma recambio haragán aluminio 60 cm	121	81125	Cepillo para pastelería fibra suave (50 mm)	143
56030	Goma recambio haragán aluminio 75 cm	121	81900	Rasqueta ergonómica con 3 lados de trabajo (200 x 125 mm)	148
56036	Goma recambio haragán aluminio 90 cm	121	81910	Rasqueta flexible para masa con agujero (146 x 98 x 1,65 mm)	150
57101	Porta fibra uso manual (230 x 100 mm)	147	81911	Rasqueta flexible para masa sin agujero (146 x 98 x 1,65 mm)	150
57110	Rascador de suelos 10 cm ancho	113	81915	Ras. flexible para masa redonda con agujero (160 x 125 x 1,65 mm)	150
57156	Cepillo limpia tuberías con mango fibra dura (ø 63 x 80 x 370 mm)	146	81916	Ras. flexible para masa redonda sin agujero (160 x 125 x 1,65 mm)	150
			82125	Cepillo para pastelería fibra suave (70 mm)	143

82900	Espátula ergonómica con 2 lados operativos (100 x 240 mm)	148	91065	Carro tsz-0017	63
82904	Espátula plástico (75 x 250 mm)	149	91066	Carro tsz-0018	64
85000	Super cubo 25 l.	116	91067	Carro tsz-0019	64
85100	Tapa para cubo 25 l.	116	91068	Carro tsz-0020	64
85200	Set 4 ruedas para cubo 25 l.	116	91069	Carro tsz-0021	64
85300	Escurreidor para cubo 25 l.	116	91070	Carro tsz-0022	64
86000	Super cubo compacto 12 l.	116	91071	Carro tsb-0001	66
86100	Tapa para cubo compacto 12 l.	116	91094	Carro tsh-0001	66
86666	Cubo 15 l. Rectangular	106	91095	Carro tsh-0002	66
86666	Cubo 15 l. Rectangular	116	91096	Carro tsh-0003	66
88040	Espátula acero inox. Flexible. Mango plástico (40 mm)	148	91097	Carro tsh-0004	66
88042	Espátula acero inox. Rígida. Mango plástico (40 mm)	148	91115	Cubo piko + base klick combi 40cm + recambio microfibra + palo extensible	56
88080	Espátula acero inox. Flexible. Mango plástico (80 mm)	148	91116	Cubo piko + base klick combi 40cm + recambio microfibra	56
88082	Espátula acero inox. Rígida. Mango plástico (80 mm)	148	91117	Soporte base para barra de carros ts-0001 y ts-0002	71
88100	Espátula acero inox. Flexible. Mango plástico (120 mm)	148	91118	Bandeja base para soporte 91117 (fondo)	71
88102	Espátula acero inox. Rígida. Mango plástico (120 mm)	148	91119	Cesta plástica para carros con asa	70
90232	Cepillo multiusos cabezal ancho f.Semidura sist resina (410 x 55 mm)	140	91120	Soporte sujeta- bolsas de residuos	71
90233	Cepillo multiusos cabezal ancho f.Dura sist resina (410 x 55 mm)	140	91121	Tapa para soporte sujeta bolsas residuos	71
90252	Cepillo panadero resina fibra semidura (340 x 35 mm)	138	91122	Bolsa residuos 60 litros para carros ts-0001 y ts-0002	71
90255	Cepillo panadero resina fibra dura (340 x 35 mm)	138	91125	Cubo piko con ruedas + base mopa klick combi 40 cm + recambio microfibra	56
90546	Cepillo de mano con mango sistema resina (275 x 70 mm)	139	91126	Carro tsk-0001	57
90548	Cepillo de mano con mango sistema resina (275 x 70 mm)	139	91127	Carro tsk-0002	57
91002	Carro ts-0001	57	91128	Carro tsk-0003	57
91003	Carro ts-0002	58	91129	Carro tsk-0004	57
91027	Cubo 6l. Para carros	70	91130	Carro tsk-0009	57
91028	Cubo 25l. Para carros	70	91131	Carro tsk-0005	58
91029	Cubo 20l. Para carros	70	91132	Carro tsk-0006	58
91031	Click para enganchar palos	70	91133	Carro tsk-0007	58
91032	Prensa gris para carros	70	91134	Carro tsk-0008	58
91033	Señal suelo mojado amarilla con mango aluminio	70	91135	Carro tsk-0010	58
91038	Carro tss-0001	59	91203	Carro tsh-0005	66
91039	Carro tss-0002	59	91204	Carro tsh-0006	67
91040	Carro tss-0003	59	91205	Carro tsh-0007	67
91041	Carro tss-0004	59	91207	Carro tsh-0008	67
91042	Carro tss-0005	59	91208	Carro tsh-0009	67
91043	Carro tss-0006	59	91209	Carro tsh-0010	67
91044	Carro tss-0007	60	91210	Carro tsh-0011	67
91045	Carro tss-0008	60	91211	Carro tsh-0012	67
91046	Carro tss-0009	60	91212	Carro tsh-0013	67
91047	Carro tss-0010	60	91213	Carro tszz-0001	69
91048	Carro ts-0025	60	91214	Carro tszz-0002	69
91049	Carro tsz-0001	60	91215	Carro tszz-0003	69
91050	Carro tsz-0002	61	91216	Carro tszz-0004	69
91051	Carro tsz-0003	61	94147	Cepillo barrer suave sistema resina (280 x 48 mm)	127
91052	Carro tsz-0004	61	94157	Cepillo de barrer semiduro sistema resina (280 x 48 mm)	127
91053	Carro tsz-0005	61	95063	Cepillo mano multiusos fibra dura sistema resina (210 x 70 mm)	142
91054	Carro tsz-0006	61	95204	Cepillo sistema resina (400 x 50 mm)	126
91055	Carro tsz-0007	61	002095	Escoba eco	8
91056	Carro tsz-0008	62	006049	Palo aluminio estriado 1,40m	26
91057	Carro tsz-0009	62	008049	Fregona microfibra colors160 g.	40
91058	Carro tsz-0010	62	009034	Cubo maya con escurridor 13l.	30
91059	Carro tsz-0011	62	02008	Escoba colors	10
91060	Carro tsz-0012	62	02010	Escoba caché	10
91061	Carro tsz-0013	62	02012	Escoba pivot lux	11
91062	Carro tsz-0014	63	02014	Escoba toscana moqueta	12
91063	Carro tsz-0015	63	02017	Escoba corner maxi	12
91064	Carro tsz-0016	63			

02018Z	Cepillo techos con palo extensible	16	04027	Cierre con llave triangular (parcialmente montado)	83
02019	Cepillo ropa	16	04030	Pedal de apertura desmontado 800l desmontado	82
02020	Cepillo calzado	16	04032	Rueda caucho 200 mm.	78
02021	Cepillo betunero	16	04034	Eje 460 mm para contenedores 120 l.	79
02027	Escobillero lux	17	04035	Eje 550 mm para contenedores 240/360 l.	79
02029	Escoba de goma	12	04036	Cañón lateral contenedor 660/800 l.	85
02041	Porta utensilios sidekick móvil	115	04037	Cañón lateral contenedor 1.100 L.	85
02044	Escoba amapola	9	04038	Rueda caucho 200 mm	84
02044	Escoba toscana	10	04039	Rueda caucho 200 mm con freno	84
02045	Cepillo barrendero suave con haragan	15	04040	Rueda caucho 160 mm	84
02046	Cepillo barrendero suave con haragán	15	04041	Rueda caucho 160 mm con freno	84
02047	Cepillo barrendero duro con haragan	15	04042	Cierre gravitacional con llave (parcialmente montado)	83
02048	Cepillo barrendero duro con haragán	15	04043	Sistema de reducción sonora 4 ruedas	83
02062	Escoba azucena	8	04044	Pantalla serigrafía	77
02064	Escoba camelia	8	04044	Pantalla serigrafía	82
02065	Escoba celinda	8	04045	Pedal de apertura desmontado 1.100 L. Desmontado	82
02066	Escoba carlina	10	04050	Cuerpo contenedor 120 l.	79
02067	Escoba lis	8	04051	Tapa contenedor 120 l. Sin "pins"	79
02068	Escoba m-10	10	04052	Cuerpo contenedor 240 l.	79
02070	Escoba jazmin	10	04053	Tapa contenedor 240 l. Sin "pins"	79
02071	Escoba jazmin moqueta	12	04054	Cuerpo contenedor 360 l.	79
02078	Escoba mimosa	12	04055	Tapa contenedor 360 l. Sin "pins"	79
02086	Escobilla w.C.	17	04056	Cuerpo contenedor 660 l con ruedas y cañones laterales	84
02089	Cepillo techos	16	04057	Tapa contenedor 660 / 800 l. Sin "pins"	85
02090	Cepillo buque eco	16	04058	Cuerpo contenedor 800 l con ruedas y cañones laterales	84
02092	Cepillo multiusos con asa	16	04059	Cue. contenedor 1.100 L tapa plana con ruedas y cañones laterales	84
02093	Escobillero eco	17	04060	Tapa contenedor 1.100 L. Plana sin "pins" ni bisagras	85
02099	Cepillo con pala de mano	34	04061	Cue. contenedor 1.100 L tapa curva con ruedas y cañones laterales	84
02100	Cepillo panadero lux	17	04062	Tapa contenedor 1.100 L. Curva completa	85
02106	Escoba jazmin exteriores	12	04063	Poste sujeta papeleras 50 l.	76
04000	Contenedor 1.100L. Tapa plana con doble tapa	80	04066	Ce.ierre estándar con llave (parcialmente montado)	78
04001	Papelera cocinas 10 l.	74	04067	Abertura para papel con buzón metálico 120 l.	77
04002	Papelera 50 l. Para poste	74	04068	Soporte metálico carretilla elevadora inoxidable	83
04005	Contenedor 120l.	74	04081	Brida sujeta papeleras	76
04007	Contenedor 240l.	74	04085	Abertura para papel con buzón metálico 240l. 360 L.	77
04008	Contenedor 180l.	74	04086	Tapa sobre tapa de caucho + agujero redondo en tapa	78
04009	Pedal para cubo 120 l. Con aro sujetabolsas	76	04086-2	2 Tapas sobre tapa de caucho + 2 agujeros redondos en tapa	83
04010	Pedal para cubo 240 l. Sin aro	76	04088	Bisagra contenedor 1.100 L. Tapa plana (1 unidad)	85
04011	Contenedor 360l.	74	04089	Pin plástico para bisagra 1.100L. (1 Unidad)	85
04012	Contenedor 600l.	80	04090	Pin plástico para bisagra 60/80/120/240l	79
04013	Contenedor 800 l.	80	04090	Pin plástico para bisagra 660 l./800 L. (1 Unidad)	85
04014	Contenedor 1.100 L. Tapa plana	80	04097	Cuerpo papeleras ecosort 60 l.	89
04015	Contenedor 1.100 L. Tapa curva con doble tapa	80	04098	Cuerpo papeleras ecosort 87 l.	89
04016	Serigrafía (coste unitario)	77	04099	Tapas papeleras ecosort estándar	90
04016	Serigrafía (coste unitario)	82	04100	Tapa batiente papeleras ecosort	90
04017	Apertura para papel	77	04101	Tapa de seguridad de documentos ecosort	90
04018	Abertura redonda en tapa	77	04102	Pedal inox para cubo 120 l. Con aro sujetabolsas	76
04019-18	Abertura redonda en tapa con roseta de goma 180mm	77	04103	Contenedor pilas 20 l.	90
04019-21	Abertura redonda en tapa con roseta de goma 210mm	77	04104	Contenedor pilas 5 l.	90
04019-24	2 Aberturas redondas en tapa con roseta de goma 240mm	82	04108	Contenedor semi soterrado 5m3 poliéster	87
04020	Cierre con llave triangular (parcialmente montado)	78	0411	Pistola de agua - alta resistencia - latón	160
04021	Cierre gravitacional con llave (parcialmente montado)	78	04110	Anclaje sujeta contenedores inox 120/240 l.	77
04022	Sistema de reducción sonora	78	04117	Compostador doméstico 220 l.	91
04023	Pegatinas de visibilidad (coste unitario)	78	04118	Compostador doméstico 320 l.	91
04023	Pegatinas de visibilidad (coste unitario)	83	04119	Recolector de agua 200 l. Completo	91
04024	Abertura para papel	82	04120	Anclaje sujeta contenedores zincado 120 l./240 L.	77
04025	Abertura para papel con buzón de plástico	82	04144	Papelera con pedal 50l. Con cubo interior	88

04145	Papelera con pedal 22l. Con cubo interior	88	07090	España activa multiusos 1 ud.	43
04146	Papelera con tapa basculante 50l.	88	07098	Microworks pack 1kg. Microfibra	42
04154	Contenedor 1.100 L. Tapa plana (nuevo modelo)	80	07099	Bobina bayeta extra absorbente con precorte 6m.	45
04191	Pedal de apertura desmontado 600l/desmontado	82	07109	Bobina bayeta multiusos con precorte 6 m.	45
04200	Campana 2,5m3 polietileno redonda montada fondo cónico	86	07111	Bayeta super microfibra 350gsm 1 ud.	43
04210	Campana 2,5m3 polietileno redonda montada 4 asas en fondo	86	07115	Pack 12 uds. Bayeta microfibra 200g. Fast	42
04220	Campana 3,2m3 polietileno cuadrada montada 4 asas en fondo	86	07116	Pack 4 bayetas multiusos idea 4 uds.	41
04221	Campana mini 1.100 L. Polietileno	86	07117	Bayeta active 360 ultra 1 ud.	43
04298	Base con ruedas papelera ecosort	89	08006	Fregona algodón 180g. Blanco	38
04309	Papelera con pedal y ruedas 70 l.	88	08007	Fregona algodón 190g. Blanco	38
06002	Palo plastificado 1,40 m.	20	08009	Fregona algodón 230g. Blanco	38
06003	Palo pintado 1,40 m. Estándar 4 colores	21	08012	Fregona algodón industrial 350g. Blanco	38
06005	Palo alu-pro 1,40m. Colores haccp	21	08014	Pinza para fregona industrial haccp	38
06006	Palo aluminio plastificado 1,40m.	26	08015	Bastidor metálico 45 cm	50
06007	Palo pintado 1,40 m. Happy line	21	08016	Bastidor metálico 75 cm	50
06009	Palo pintado alufass 1,40 m.	21	08017	Bastidor metálico 100 cm	50
06010	Palo slalom decorado 1,40 m.	20	08018	Base mopa plástico spl 40 cm	52
06014	Palo extensible pintado 1,5 m.	27	08019	Base mopa plástico spl 50 cm	52
06015	Palo extensible pintado 3 m.	27	08020	Base mopa húmeda plástico spl 40 cm	53
06016	Palo plastificado aluminio 1,40m.	26	08021	Base mopa húmeda plástico spl 50 cm	53
06017	Palo aluminio anodizado haccp 1,40m.	26	08027	Recambio algodón mopa 45 cm	50
06018	Palo aluminio anodizado 1,50m.	26	08028	Mopa microfibra con recambio 40cm	51
06019	Palo pintado alu-pro 1,50 m. Diámetro profesional	22	08029	Recambio algodón mopa 75 cm	50
06022	Palo cepillo barrendero	15	08030	Recambio algodón mopa 100 cm	50
06025	Palo extensible plastificado 1,50 m.	27	08035	Mopa con bolsillos microfibra 40 cm	52
06027	Palo extensible 1,5 m aluminio con esponja	27	08036	Mopa con bolsillos microfibra 50 cm	52
06031	Palo plastificado 1,20 m.	20	08039	Mopa húmeda con solapas microfibra 40 cm	53
06035	Palo plastificado 1,40 m. Brillante	20	08040	Mopa húmeda con solapas microfibra 50 cm	53
06043	Palo pintado alu-pro 1,40 m. Diámetro profesional	22	08050	Fregona microfibra tiras 155 g	40
06052	Palo extensible 3 m aluminio con esponja	27	08051	Fregona microfibra tiras 170 g.	40
06053	Palo ergo pro 1,40 m diametro profesional	23	08053	Recambio algodón mopa 60 cm	50
07003	Bayeta multiusos posavajillas 1 ud.	43	08054	Bastidor metálico 60 cm	50
07006	Pack 1 ud. Bayeta cristales extra perforada	42	08055	Fregona algodón 250g. Crudo	38
07012	Pack 5 uds. Bayeta rapid profesional	41	08058	Recambio algodón mopa 140 cm	50
07013	Pack 5 uds. Bayetas cristales profesional	42	08059	Bastidor metálico 140 cm	50
07015	Pack 5 uds. Bayeta microplus profesional	41	08075	Recambio microfibra mopa 45 cm	51
07016	Pack 5 uds. Bayeta microblue xxl profesional	41	08076	Recambio microfibra mopa 60 cm	51
07019	Pack 5 uds. Bayeta microfibra terry profesional 300g.	42	08077	Recambio microfibra mopa 75 cm	51
07020	Pack 5 uds. Bayeta microfibra terry profesional 200g.	42	08078	Base mopa klick combi para cubo piko universal 40 cm	53
07022	Bobina bayeta multiusos con precorte 8 m.	45	08079	Mopa para base klick combi	53
07023	Bobina bayeta extra absorbente con precorte 8m.	45	08081	Fregona micromop pro	39
07049	Bobina bayeta rapid con precorte 14m.	45	08086	Fregona microfibra blanca 160 g.	40
07059	Bobina bayeta rapid con precorte 8m.	45	08107	Recambio mopa microfibra 40cm	51
07061	Bobina bayeta posavajillas con precorte 8m.	46	09000	Cubo con escurridor basic 10l.	30
07063	España evo profesional (haccp)	44	09001	Cubo con escurridor ovalado basic 12l.	30
07075	Rollo bayeta microglass con precorte 12 uds.	46	09002	Cubo basura basic 15 l. Con tapa	33
07076	Rollo bayeta microfood 500 servicios con precorte	46	09003	Cubo basura y tapa 90l.	88
07077	Bobina bayeta multiusos con precorte 2 m.	45	09004	Cubo basura y tapa 50l.	88
07078	Bobina bayeta extra absorbente con precorte 2m.	45	09021	Recogedor basic con palo	34
07079	Bobina bayeta rapid con precorte 2m.	45	09022	Recogedor plegable + palo	34
07080	Bobina bayeta posavajillas con precorte 2m.	46	09024	Recogedor con goma + palo metálico	34
07082	Bobina bayeta multiusos con precorte 14 m.	45	09025	Recogedor galvanizado + palo	35
07083	Bobina bayeta extra absorbente con precorte 14m.	45	09029	Cubo con escurridor ovalado 14l.	33
07084	Rollo bayeta microglass con precorte 6 uds.	46	09030	Cubo con escurridor rectangular 14l.	33
07085	Bobina bayeta posavajillas con precorte 14m.	46	09032	Pala de mano con goma	34
07088	Bayeta microfibra especial cristales 1 ud.	43	09037	Cubo con escurridor colores 13l.	31
07089	Bayeta microfibra especial muebles 1 ud.	43	09047	Cubo con escurridor ovalado 15 l. Basic	33

09050	Cubo con escurridor ovalado 15l.	32	C29903	Mango de una pieza ergonómico super higiénico (1300 x 32 mm)	170
09057	Recogedor basculante + palo	34	C29904	Mango de una pieza ergonómico super higiénico (1500 x 32 mm)	
09064	Recogedor galvanizado pintado + palo	35	C50153	Cepillo estrecho para maquinaria (275 x 20 mm)	173
09069	Cubo + escurridor eco con pico 13 l.	30	C51126	Cepillo panadero fibra muy suave (410 x 55 mm)	174
09082	Cubo con escurridor y asa plástica 16l.	32	C52126	Cepillo recto fibra muy suave (300 x 20 mm)	174
09085	Cubo con escurridor y asa metal 16l.	31	C54134	Cepillo mano redondo fibra semidura (ø 125 mm)	171
09089	Papelera con pedal 30 l.	88	C57156	Cepillo limpiatuberías con mango fibra dura (ø 63 x 80 x 370 mm)	174
09095	Recogedor con palo metálico + goma	34	C80101	Cubo 15 litros con asa	171
15010E	Limpiacristales reversible	106	C80111	Tapa cubo 15 l.	171
15109-6	Espátula nylon (110 x 250 mm) negro para 240° c	149	C80200	Recogedor abatible con mango una pieza (330 x 310 x 125 mm)	
15150D	Colgador para palos individual	27	C80201	Recogedor abatible sin palo	172
70233-2	Cep. .Multi. cabezal ancho f. Dura metal detec. azul (410 x 55 mm)	154	C80205	Recogedor abatible de mano	172
70255-2	Cepillo panadero metal detectable fibra dura azul (340 x 35 mm)	154	C80301	Pala de mano extra fuerte (300 x 310 mm)	170
70548-2	Cep. limpia lecheras metal detectable fibra.Dura azul (275 x 70 mm)	154	C80305	Pala de mano (270 x 320 x 540 mm)	175
72166-2	Cepillo para harina fibra dura metal detectable azul (300 x 20 mm)	154	C81911	Rasqueta flexible para masa sin agujero (146 x 98 x 1,65 mm)	169
74166-2	Cep. Poliéster filamentos detectables (400 x 50 mm)	126	C81916	Rasqueta flexible redonda sin agujero (160 x 125 x 1,65 mm)	169
75063-2	Cep. mano multiusos fibra dura metal detec. azul (210 x 70 mm)	154	C82900	Espátula ergonómica con 2 lados operativos (100 x 240 mm)	169
78157-2	Cepillo barrer semiduro azul fibras detectables (280 x 48 mm)	127	C82904	Espátula plástico (75 x 250 mm)	169
82910-6	Espátula nylon (75 x 250 mm) negro para 240°c	149	GS3210104	Botella pulverizadora doble acción redonda greenspeed	98
C10201	Cepillo multiusos mango corto fibra semidura (270 x 47 mm)	173	GS3210106	Botella pulverizadora doble acción redonda greenspeed	98
C10232	Cepillo multiusos cabezal ancho fibra semidura (410 x 55 mm)	174	GS3300137	Guante microfibras dos caras greenspeed	94
C10252	Cepillo panadero fibra semidura (340 x 35 mm)	171	GS3300412	Diamond mop 45 cm greenspeed	95
C10546	Cepillo de mano con mango fibra semidura (275 x 70 mm)	171	GS3300430	Esponja diamond splinky 9 x 15	94
C10713	Limpiatubos (ø 55 x 140 x 450 mm)	174	GS3300456	Bayeta diamond greenspeed 40 x 40	94
C10754	Limpiatubos (ø 55 x 140 x 450 mm)	174	GS3300611	Bayeta microfibras basic greenspeed 40 x 40	94
C121	Cutter de seguridad pequeño cerámico slice	178	GS3300705	Bayeta cristales greenspeed 40 x 40	94
C122	Cutter de precisión cerámico slice	178	GS3300827	Dustmop velcro 45 cm greenspeed	95
C124	Cutter "box" cerámico slice	178	GS3300829	Dustmop velcro 60 cm greenspeed	95
C125	Cutter "box" cerámico auto-retráctil slice	178	GS3300860	Recambio dustbow 8 x 55 cm greenspeed	96
C126	Cutter lápiz cerámico auto-retráctil slice	178	GS3300870	Recambio plumero fox pequeño microfibras greenspeed	96
C127	Pinzas combo antideslizantes rojas	179	GS3300874	Recambio plumero fox mediano microfibras greenspeed	96
C128	Pinzas combo inox grises	179	GS3301011	Bayeta microfibras original greenspeed 40 x 40	94
C129	Pinzas en punta antideslizantes rojas	179	GS3301024	Multimop velcro 30 cm greenspeed	95
C130	Pinzas en punta inox grises	179	GS3301030	Glass mop velcro 30 cm greenspeed	95
C131	Tijeras de precisión con hojas finas	179	GS3301039	Scrubmop velcro 45 cm greenspeed	95
C132	Tijeras de precisión con hojas anchas	179	GS3301041	Scrubmop velcro 60 cm greenspeed	95
C14103	Pala monobloque, mango corto (270 x 340 x 1120 mm)	175	GS3301042	Minipad 9 x 16 cm frotar greenspeed	96
C14104	Pala monobloque, mango corto (330 x 380 x 1120 mm)	175	GS3301073	Twistmop velcro 45 cm greenspeed	95
C15060	Cepillo uñas fibra intermedia (110 x 45 mm)	173	GS3301075	Twistmop velcro 60 cm greenspeed	95
C15061	Cepillo uñas fibra dura (110 x 45 mm)	173	GS3301117	Base mopa aluminio multilink 23cm greenspeed	97
C15064	Cepillo mano multiusos fibra semidura (210 x 70 mm)	174	GS3301120	Base mopa aluminio 40cm estándar greenspeed	97
C15103	Pala monobloque, mango largo (270 x 340 x 1330 mm)	175	GS3301125	Base mopa aluminio 55cm estándar greenspeed	97
C15104	Pala monobloque, mango largo (330 x 380 x 1330 mm)	175	GS3301152	F.I.T. (Floor mop injection tool)	98
C15105	Pala de mano (110 x 150 x 265 mm) 500g	169	GS3301161	Palo sprenkler limited 1,45 m. Greenspeed	101
C15106	Pala de mano (135 x 185 x 310 mm) 750g	169	GS3301192	Soporte manual ergogrip pequeño con velcro	98
C15107	Pala de mano (160 x 230 x 360 mm) 1000g	169	GS3301196	Soporte manual ergogrip mediano con velcro	98
C15109	Espátula plástico (110 x 250 mm)	169	GS3301406	Base mopa winglet multifix 30cm greenspeed	97
C165	Cutter cerámico "mini" autoretractil	178	GS3301412	Base mopa winglet 40cm estándar greenspeed	97
C166	Cutter lápiz cerámico no retráctil slice	178	GS3301422	Base mopa winglet 55cm estándar greenspeed	97
C21136	Cepillo barrendero fibra suave(400 x 60 mm)	170	GS3311108	Palo extensible 2 secciones ergonómico 1,8m. Greenspeed	98
C24147	Cepillo de barrer suave (280 x 48 mm)	173	GS3320250	Mango flexible para dustbow greenspeed	96
C25155	Cepillo barrendero fibra semidura (400 x 60 mm)	170	GS3320270	Soporte flexible atrapolvo pequeño	96
C26155	Cepillo barrendero fibra semidura (500 x 600 mm)	170	GS3320274	Soporte flexible atrapolvo mediano	96
C27131	Cepillo limpiatuberías c/acople mango (ø 70 x 95 x 120 mm)	173	GS3360405	Bayeta original hd microfibras 62x52	94
C27133	Cepillo limpiatuberías c/acople mango (ø 90 x 105 x 130 mm)	173	GS3360600	Bayeta microfibras doble uso 31 x 31	94
C27134	Cepillo limpia tanques fibra media (200 x 120 mm)	171	SC10420	Tijeras acero inoxidable slice	179
C29902	Palo de una pieza ergonómico para recogedor (1000 x 32 mm)	172			

The logo for Maya Professional Tools, featuring the word "maya" in a white, lowercase, sans-serif font with a white curved line underneath it, set against a blue square background.

PROFESSIONAL TOOLS

C/ Flassades, num 5
Ontinyent (Valencia) · Spain
Tel. 962 389 059

www.grupomaya.com.es
info@grupomaya.com.es

Styling & Design:
www.pimpamestudio.com

Photography:
Pinhole Estudio

Copyright ©2015 Entidad Maya S.L.