

SERIE abisagrada a45



SERIE abisagrada a45

SISTEMAS integra



## SERIE ABISAGRADA A45

### Ensayos y Certificados

Permeabilidad al aire: Clase 4

Estanqueidad al agua: E 750

Resistencia al viento: C4

Atenuación Acústica: 36(-2;-5)dB

## CARACTERÍSTICAS

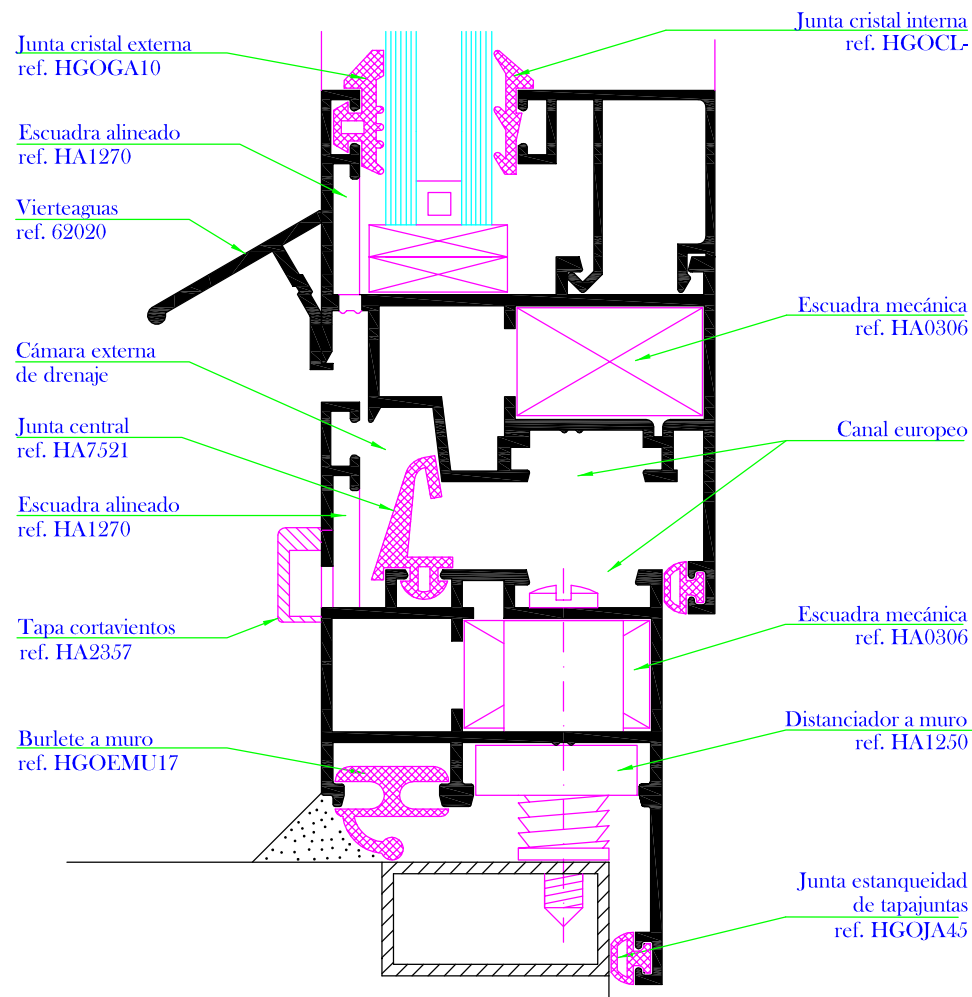

- Anchos de 45 mm. de cerco y 52 mm. de hoja.
- Sistema de cierre por junta central de estanqueidad en EPDM, de elevadas prestaciones de hermeticidad y aislamientos térmico y acústico.
- Cámara europea estándar para alojamiento de herrajes.
- Cámara externa con canal para drenaje directo al exterior y tapa cortavientos de desagüe en poliamida.
- Junta perimetral interior en hoja.
- Ajuste y fijación a muro por medio de distanciador en poliamida y burlete perimetral exterior con soporte del sellador.
- Tapajuntas incorporado o clipado mediante piezas especiales en poliamida, con burlete perimetral a muro.
- Capacidad de acristalado de 35 mm. en cercos y 42 mm. en hojas con altura de galce de 22 mm.
- Coplanar exteriormente y con resalte de hoja sobre el cerco al interior, en la línea de las tendencias arquitectónicas actuales.
- Amplia gama de perfiles que permiten solucionar la más completa variedad de propuestas en cerramientos.

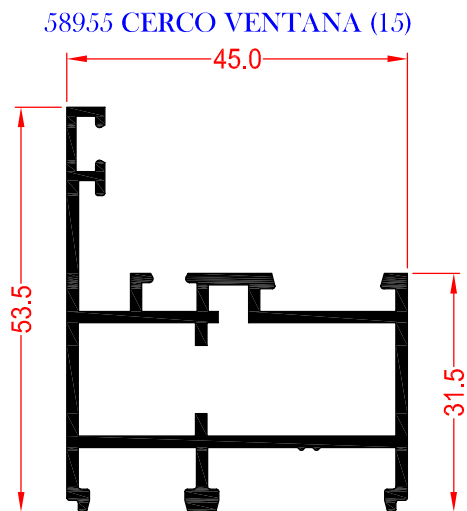

58956 CERCO VENTANA CON SOLAPE

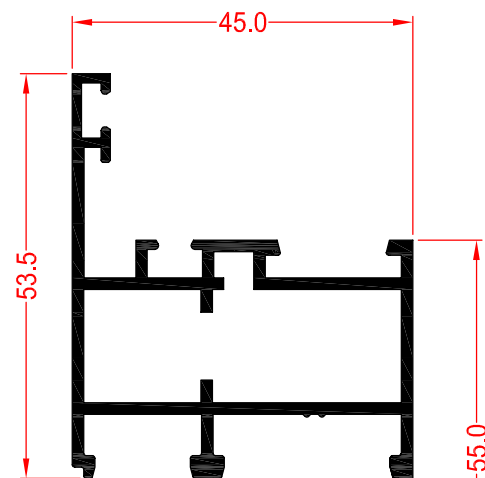

58960 CERCO PUERTA CON SOLAPE

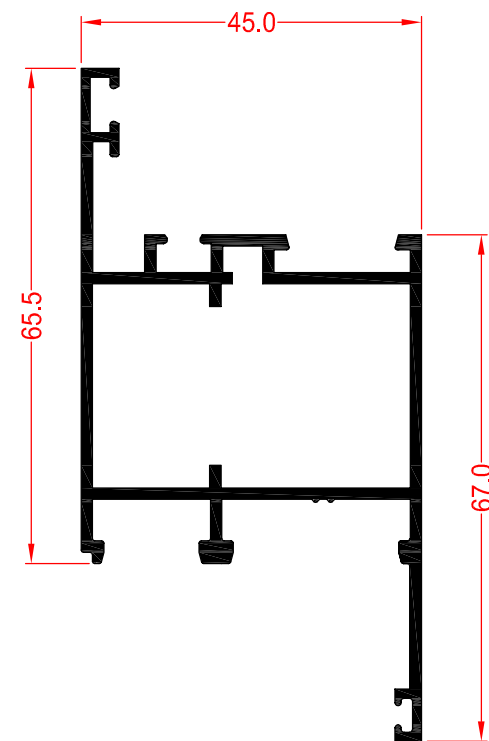

58958 CERCO PUERTA (27)

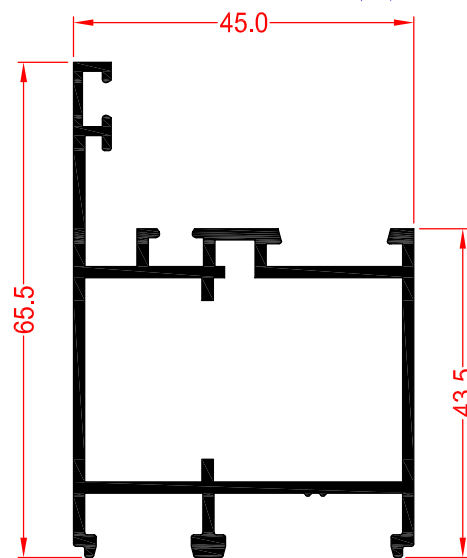

70529 CERCO VENTANA (15)

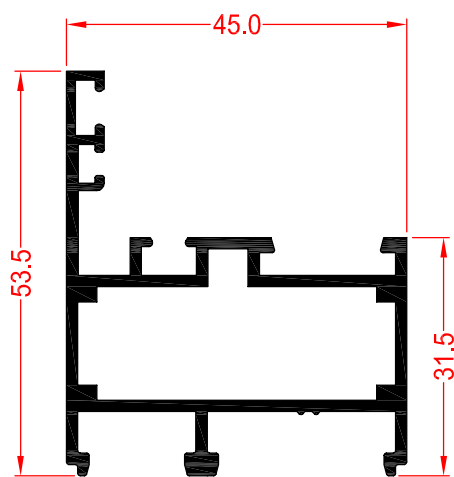

PERFILES

70530 CERCO VENTANA CON SOLAPE

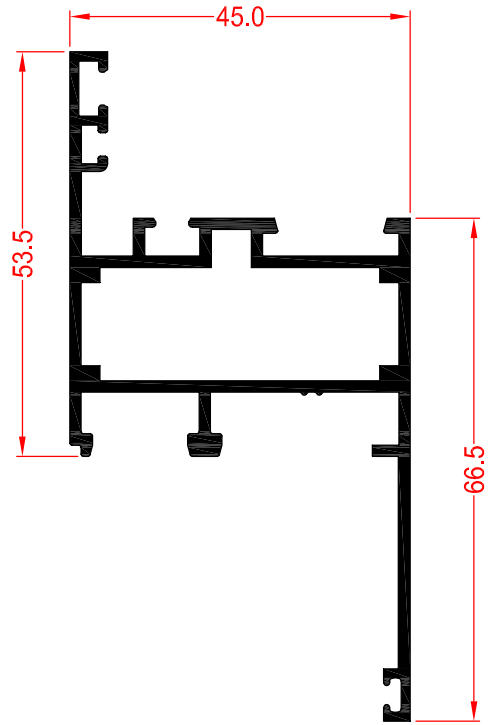

70365 INVERSOR CURVO

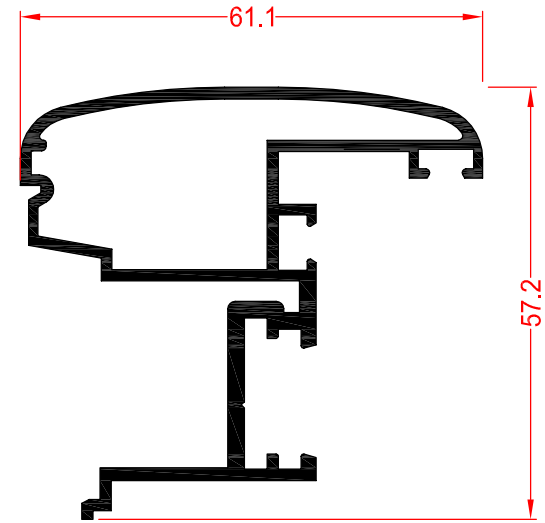

70363 CERCO VENTANA (15)

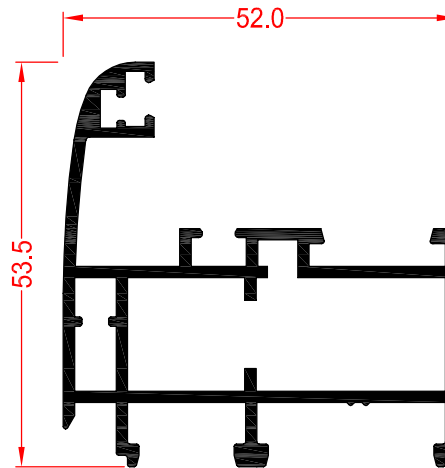

SERIE abisagrada a45

62702 CERCO PUERTA APERTURA EXTERIOR

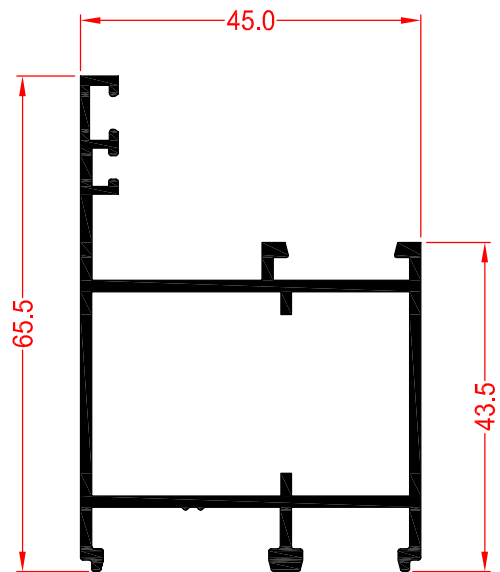

61141 CERCO VENTANA APERT. EXT. SOLAPE

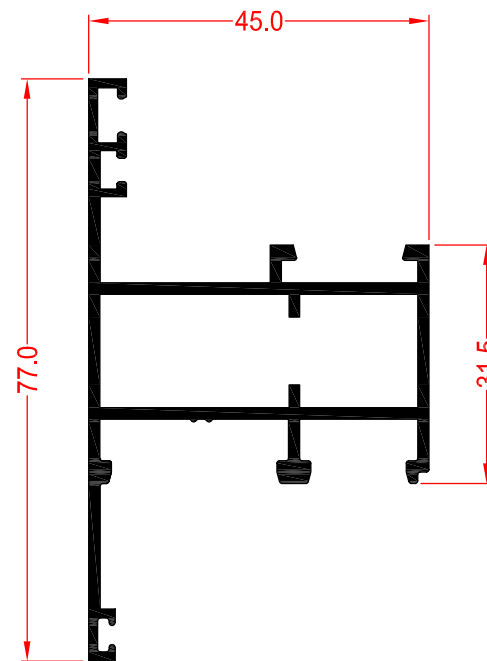

62091 CERCO VENTANA APERT. EXT.

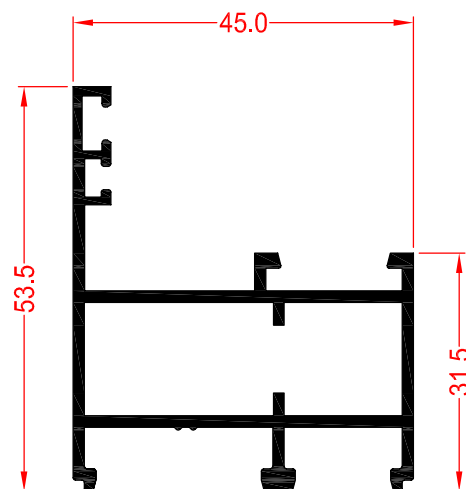

PERFILES

59736 HOJA PUERTA (27)

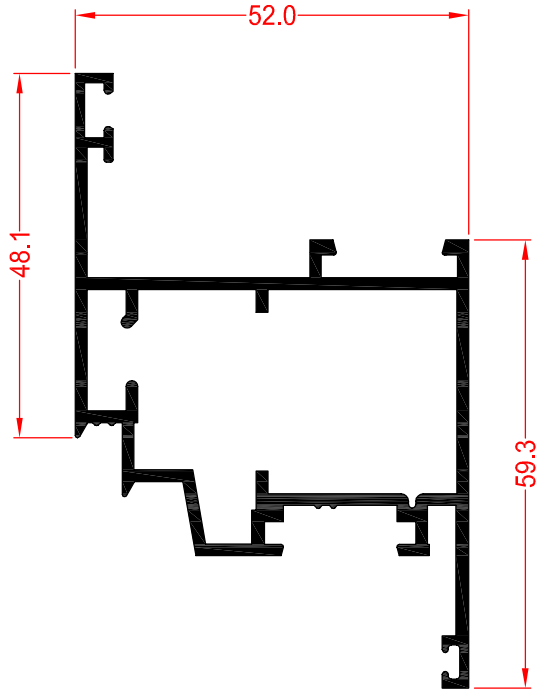

62673 HOJA CURVA VENTANA (15)

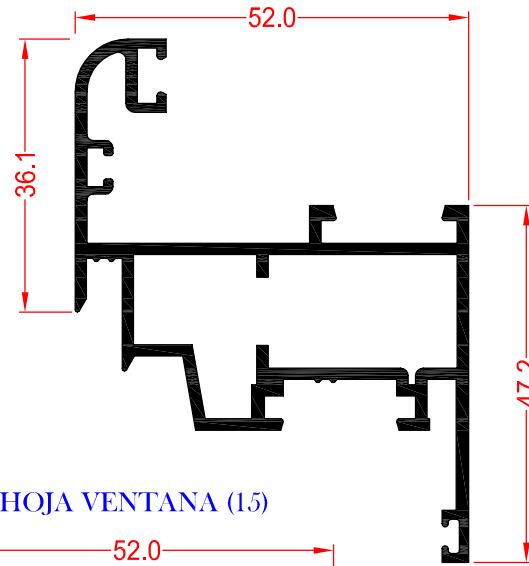

59735 HOJA VENTANA (15)

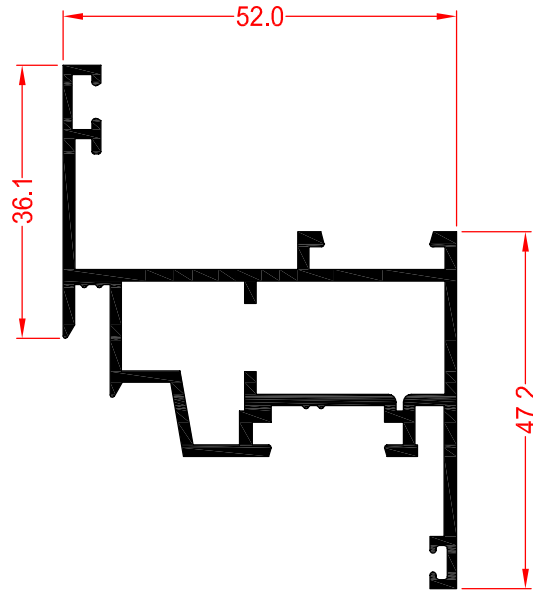

58963 HOJA PUERTA (40)

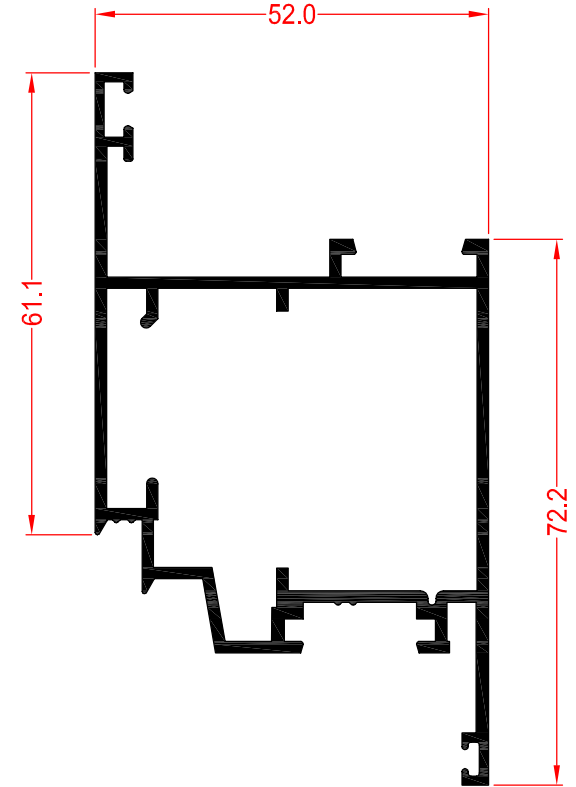

SERIE abisagrada a45

64467 HOJA CURVA SIN JUNQUILLO (40)

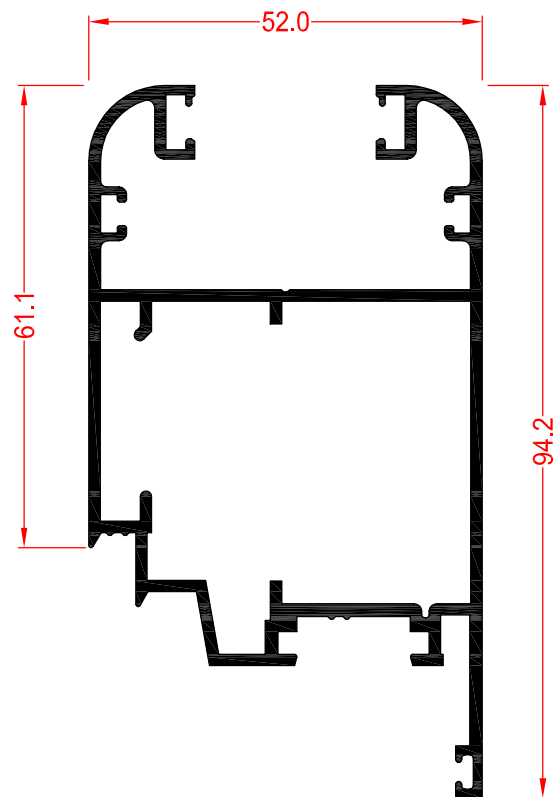

66605 HOJA CURVA SIN JUNQUILLO (27)

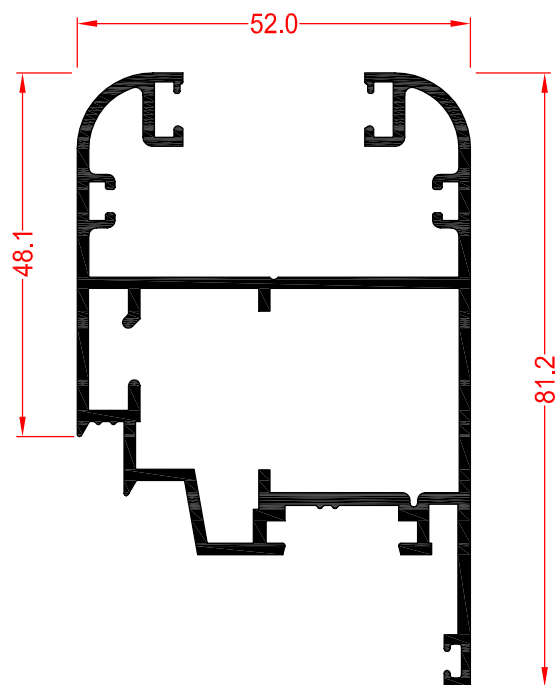

63738 HOJA CURVA SIN JUNQUILLO (15)

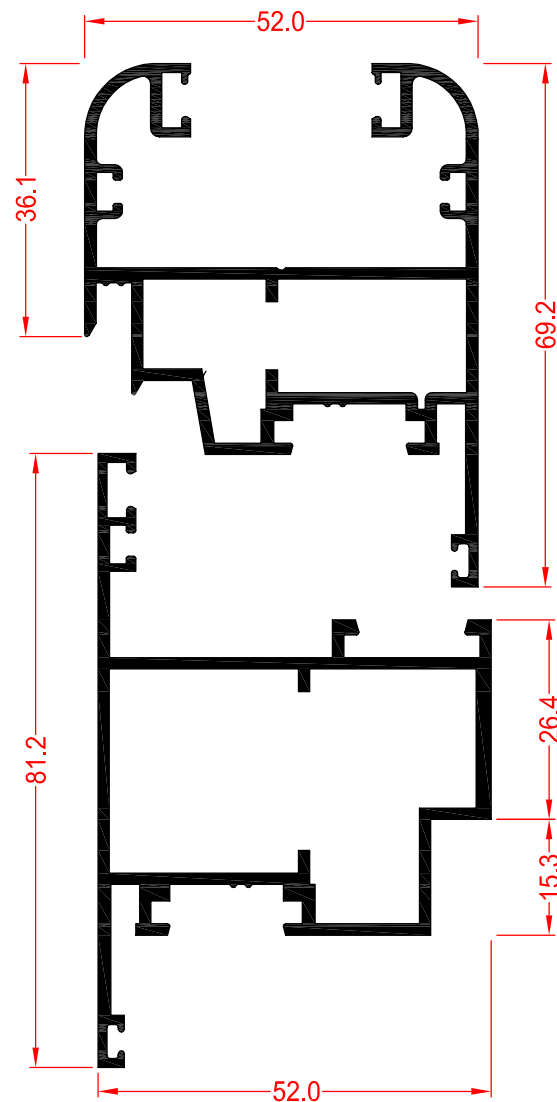

62092 HOJA APERTURA EXT. (27)



PERFILES

70531 HOJA VENTANA (15)

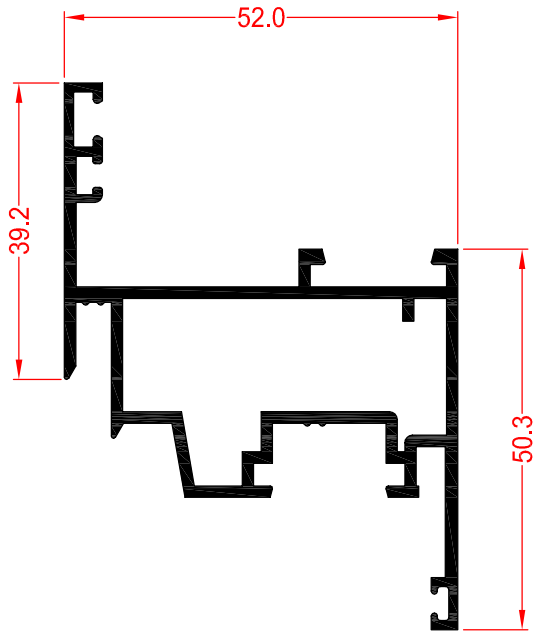

70364 HOJA CURVA VENTANA (15)

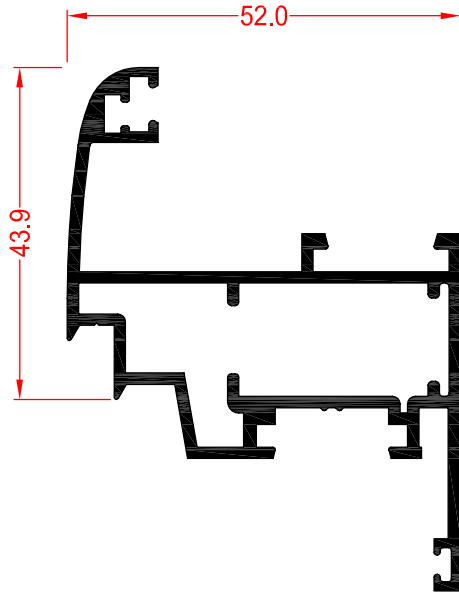

70532 HOJA CURVA VENTANA (15)

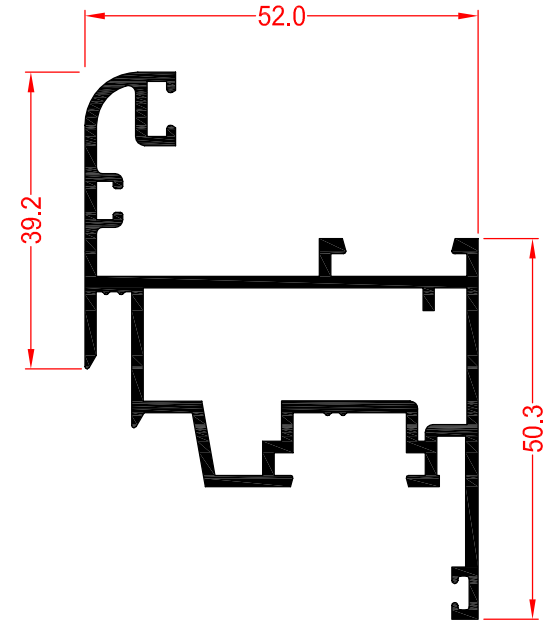

SERIE abisagrada a45

61189 HOJA PUERTA APERT. EXT.

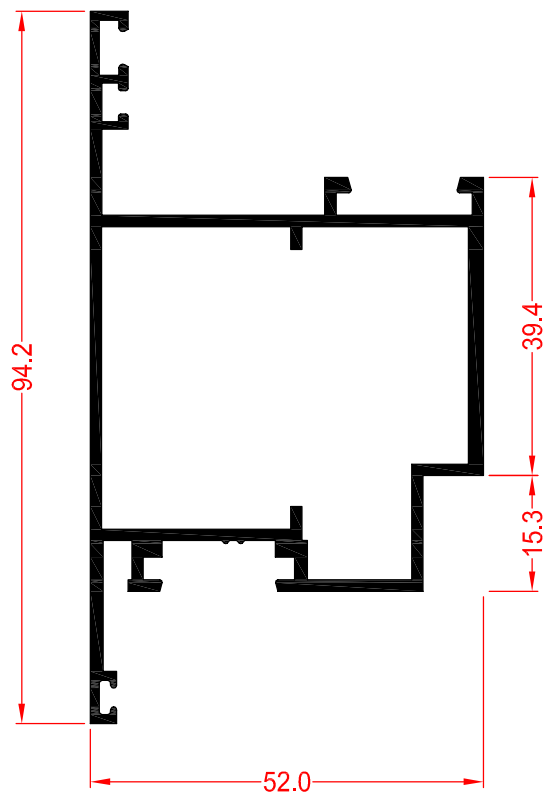

59734 INVERSOR

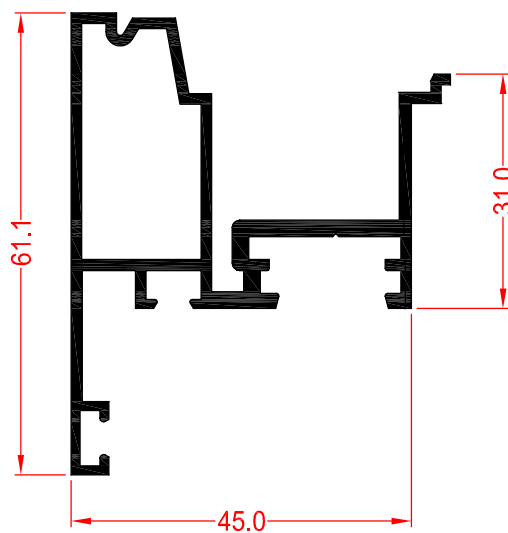

65188 HOJA PUERTA CURVA (40)

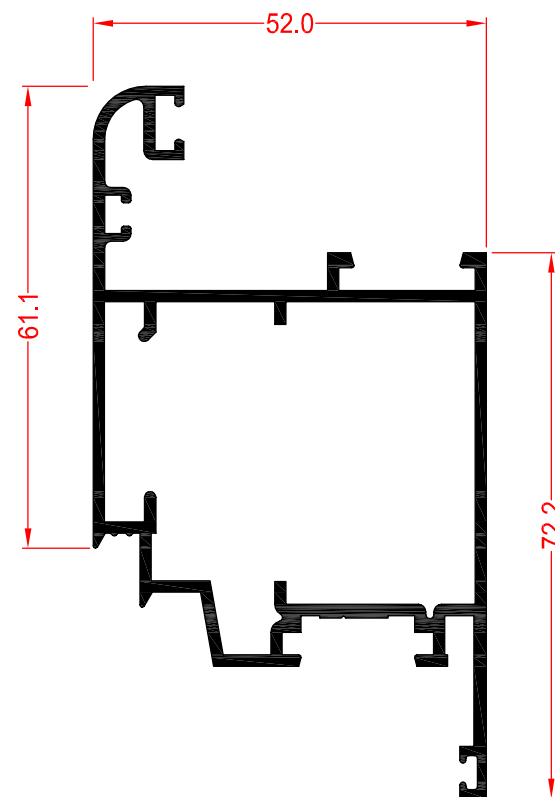

PERFILES

67527 HOJA CURVA APERT. EXT.

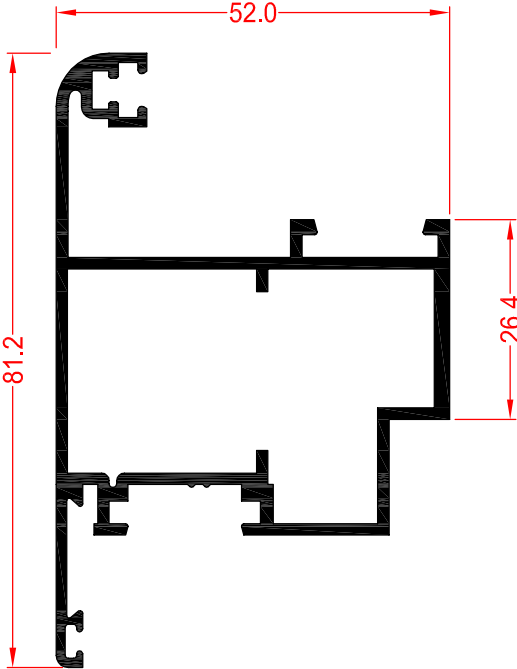

70215 HOJA CURVA APERT. EXT.

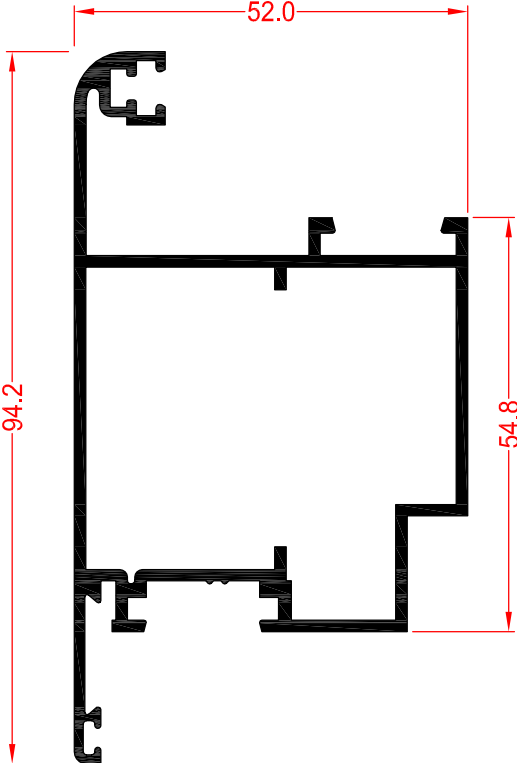

SERIE abisagrada a45

SERIE abisagrada a45

62285 TRAVESAÑO DE CERCO (97)

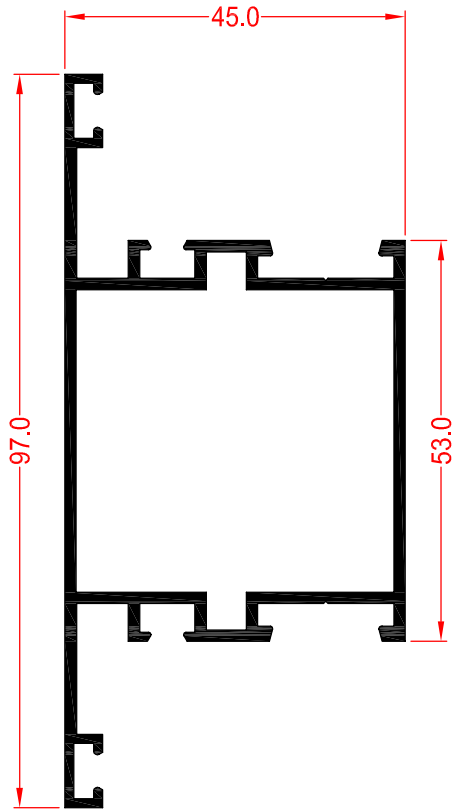

59890 PEANA BALCONERA

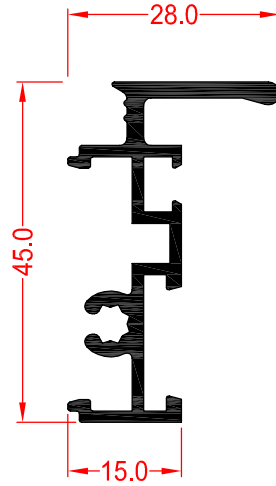

58961 TRAVESAÑO DE CERCO (83)

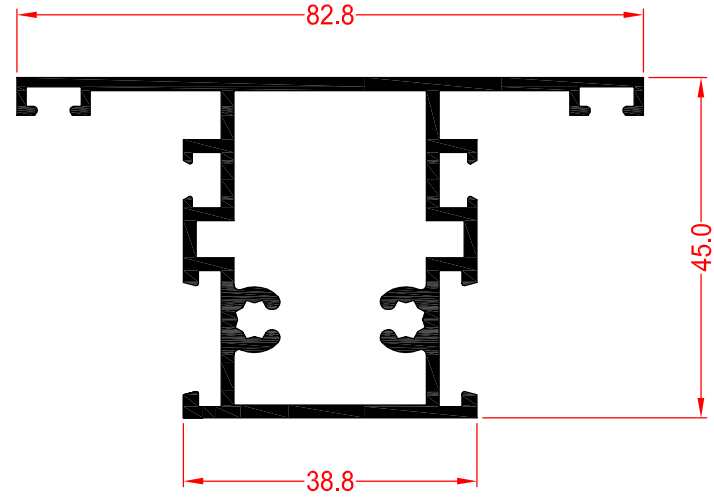

60538 TRAVESAÑO DE CERCO (158.5)

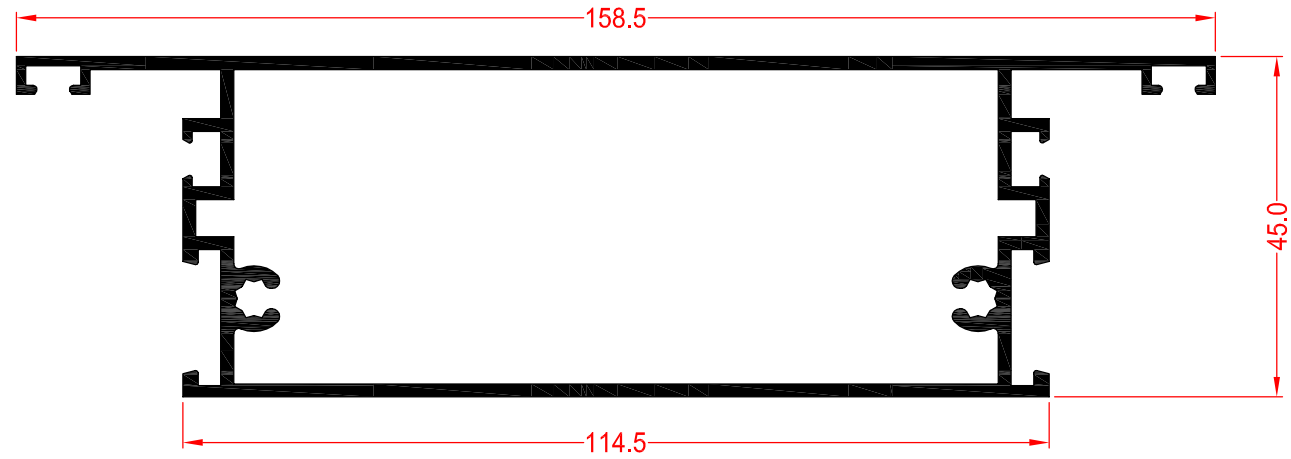

# PERFILES

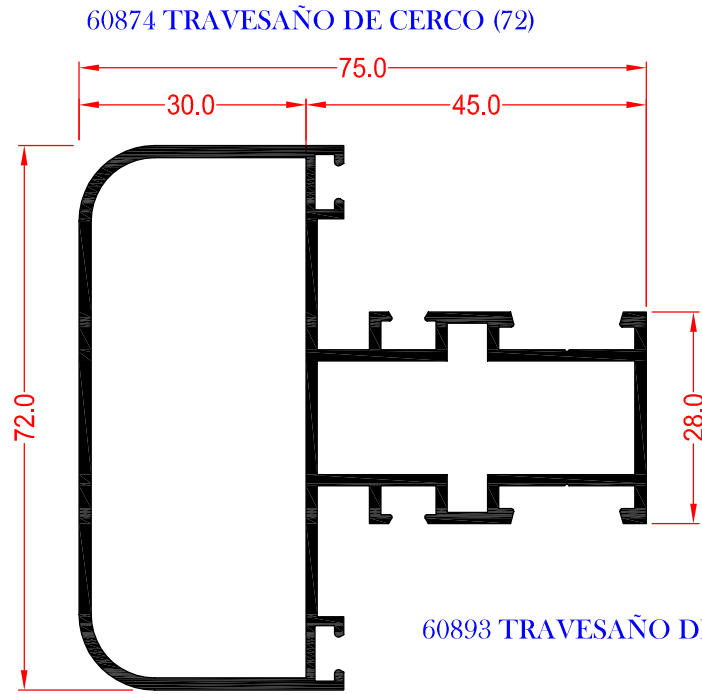

60893 TRAVESAÑO DE CERCO (72)

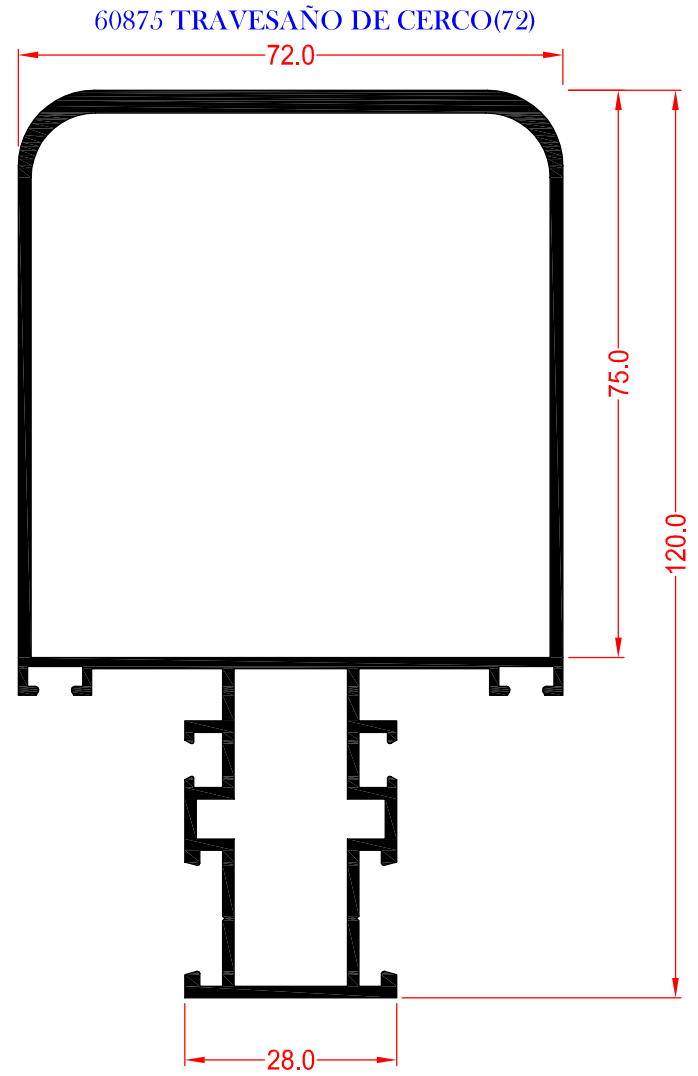
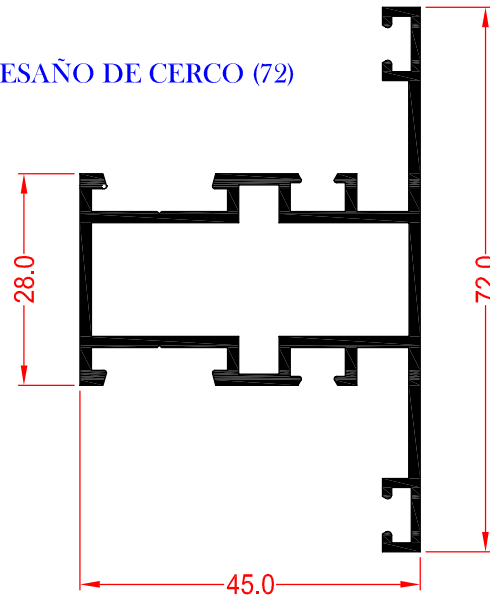

SERIE abisagrada a45

SERIE abisagrada a45

60892 TRAVESAÑO DE HOJA (72)

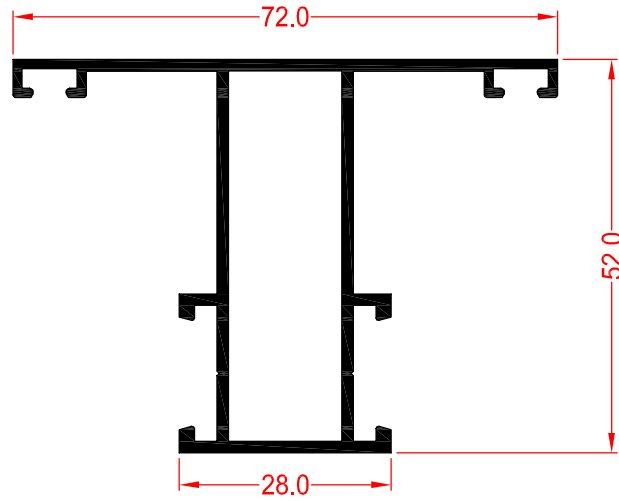

58962 CIERRE INFERIOR

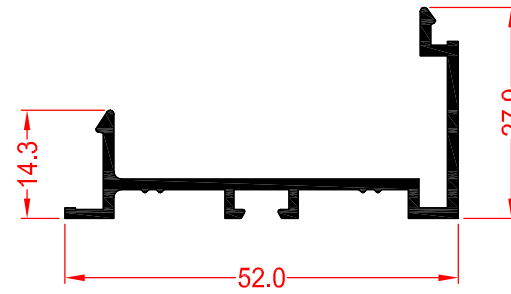

61142 TRAVESAÑO DE HOJA (94)

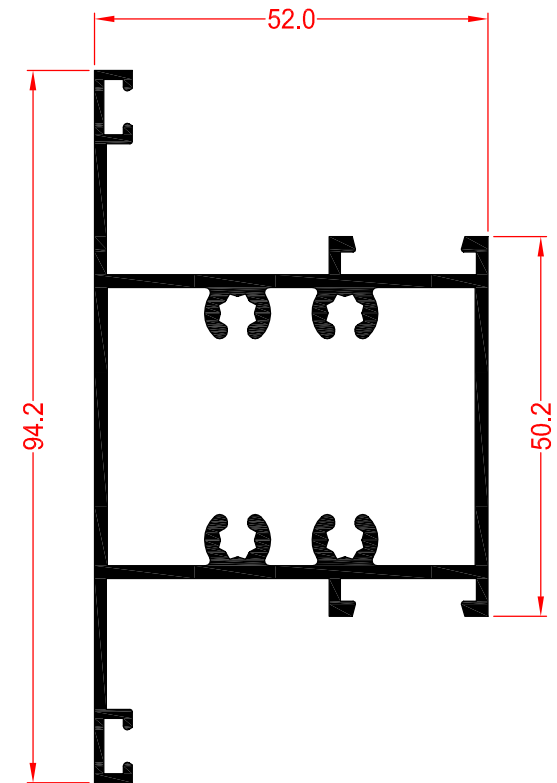

58953 TRAVESAÑO DE HOJA (158.5)

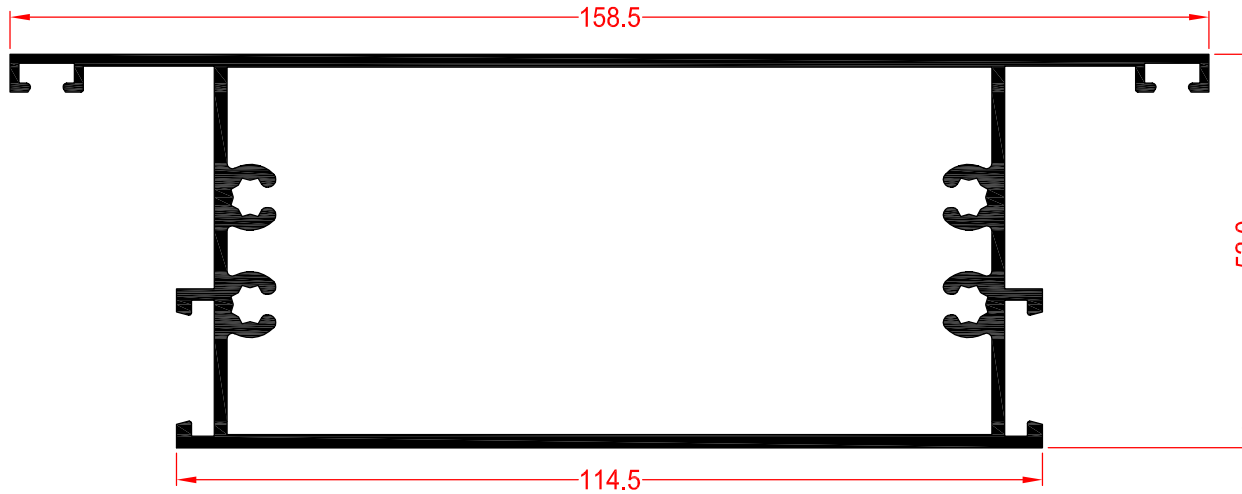

SISTEMAS integra

PERFILES

SERIE abisagrada a45

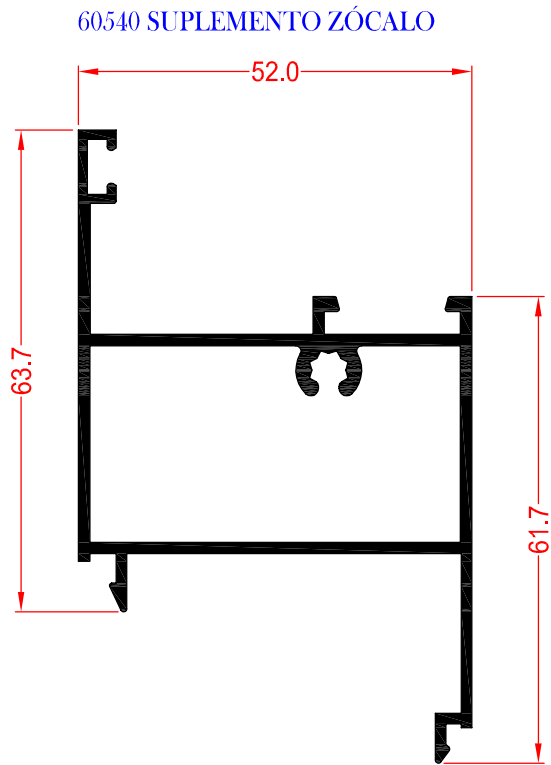

63549 INVERSOR CAMBIO APERT. EXTERIOR

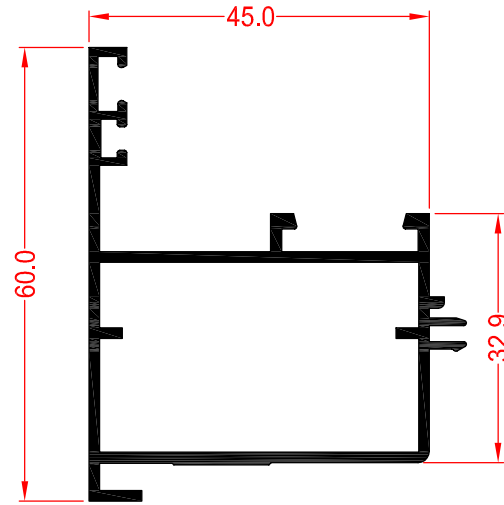

63550 INVERSOR CAMBIO APERT. EXTERIOR

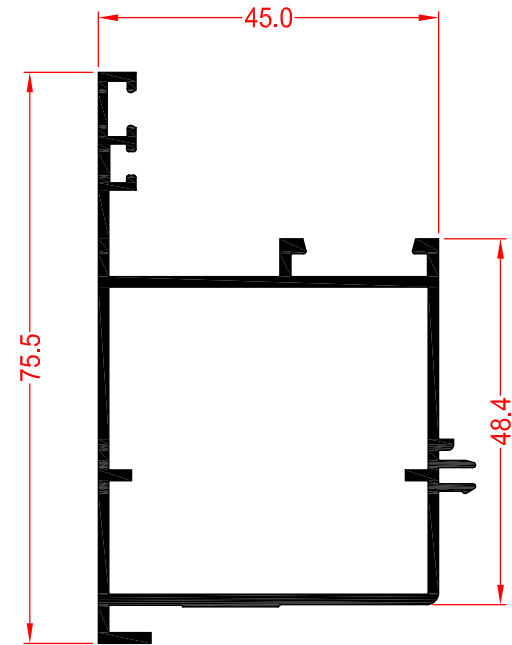

61140 INVERSOR APERT. EXTERIOR

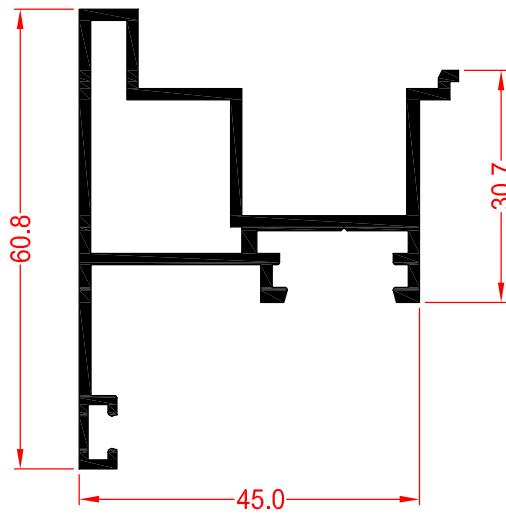

SERIE abisagrada a45

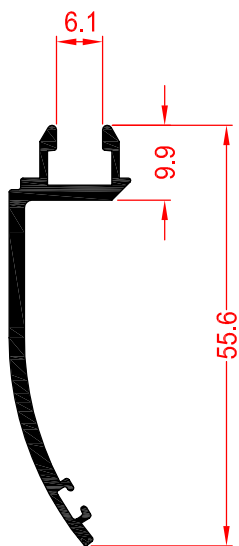

61740

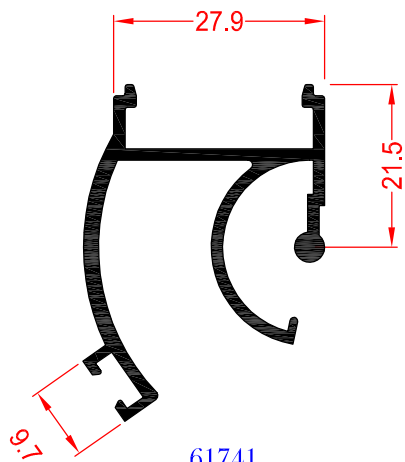

61741

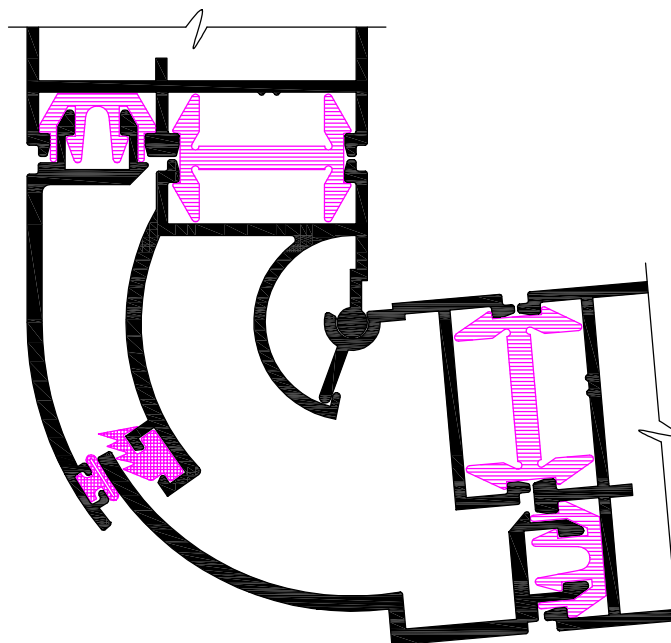

61742

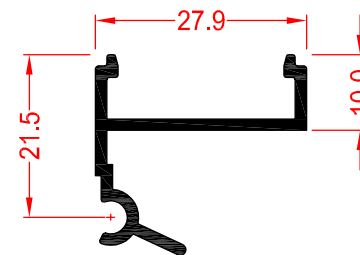

61743

ESQUINERO REGULABLE

SISTEMAS integra



# JUNQUILLOS

SERIE abisagrada a45

FÓRMULA DE CÁLCULO PARA  
ACRISTALAMIENTOS SOBRE  
HOJAS DE CANTO CURVO

$$52-12-X=C$$

INDICA ANCHURA  
JUNQUILLO

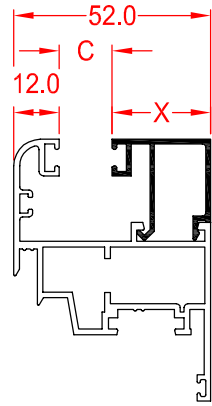

FÓRMULA DE CÁLCULO PARA  
ACRISTALAMIENTOS SOBRE  
HOJAS DE CANTO RECTO



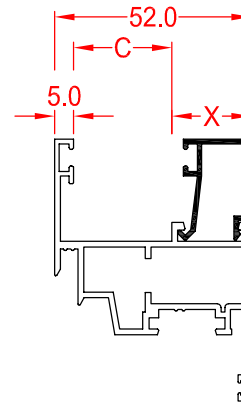





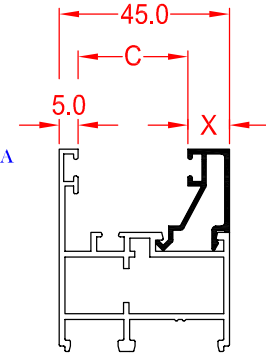

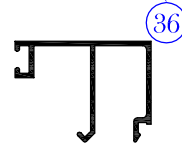
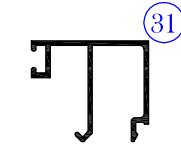
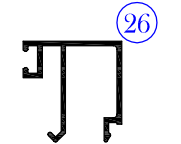
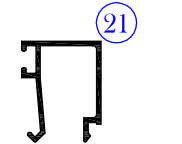
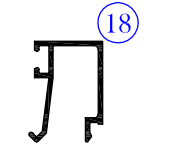
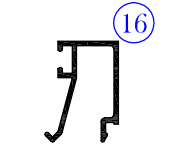
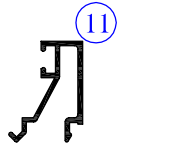
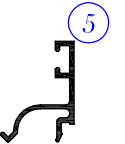
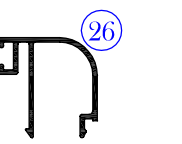
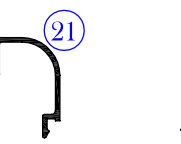
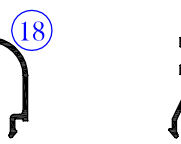
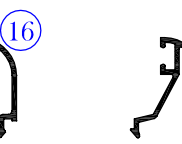

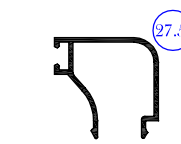
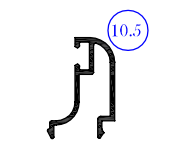
$$52-5-X=C$$

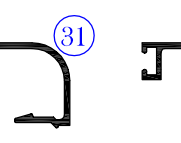
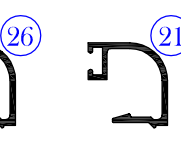

FÓRMULA DE CÁLCULO PARA  
ACRISTALAMIENTOS SOBRE  
MARCOS

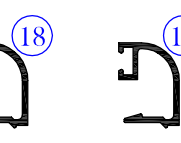
$$45-5-X=C$$

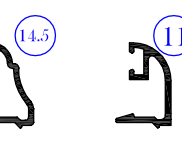

- |   |   |   |  |   |   |   |   |   |   |   |
|---|---|---|--|---|---|---|---|---|---|---|
|    |    |    |    |    |    |    |    |   |   |   |
| 59850   | 59849   | 58948   | 58949  | 62167   | 59848   | 59847   | 60895   |   |   |   |
|   |   |   |   |   |   |   |   |   |   |   |
| 64053   | 64052   | 64246   | 64247  | 64248   | AM19  | AM10  | AM11  | AM22  |   |   |
|  |  |  |  |  |  |  |  |  |  |  |
| 64555   | 64554   | 64553   | 64552  | AM23  | 64421   | 64556   | AM24  | AM21  | 64557   | 64570   |

ESCALA 1:2

(VER APARTADO PERFILES COMUNES)



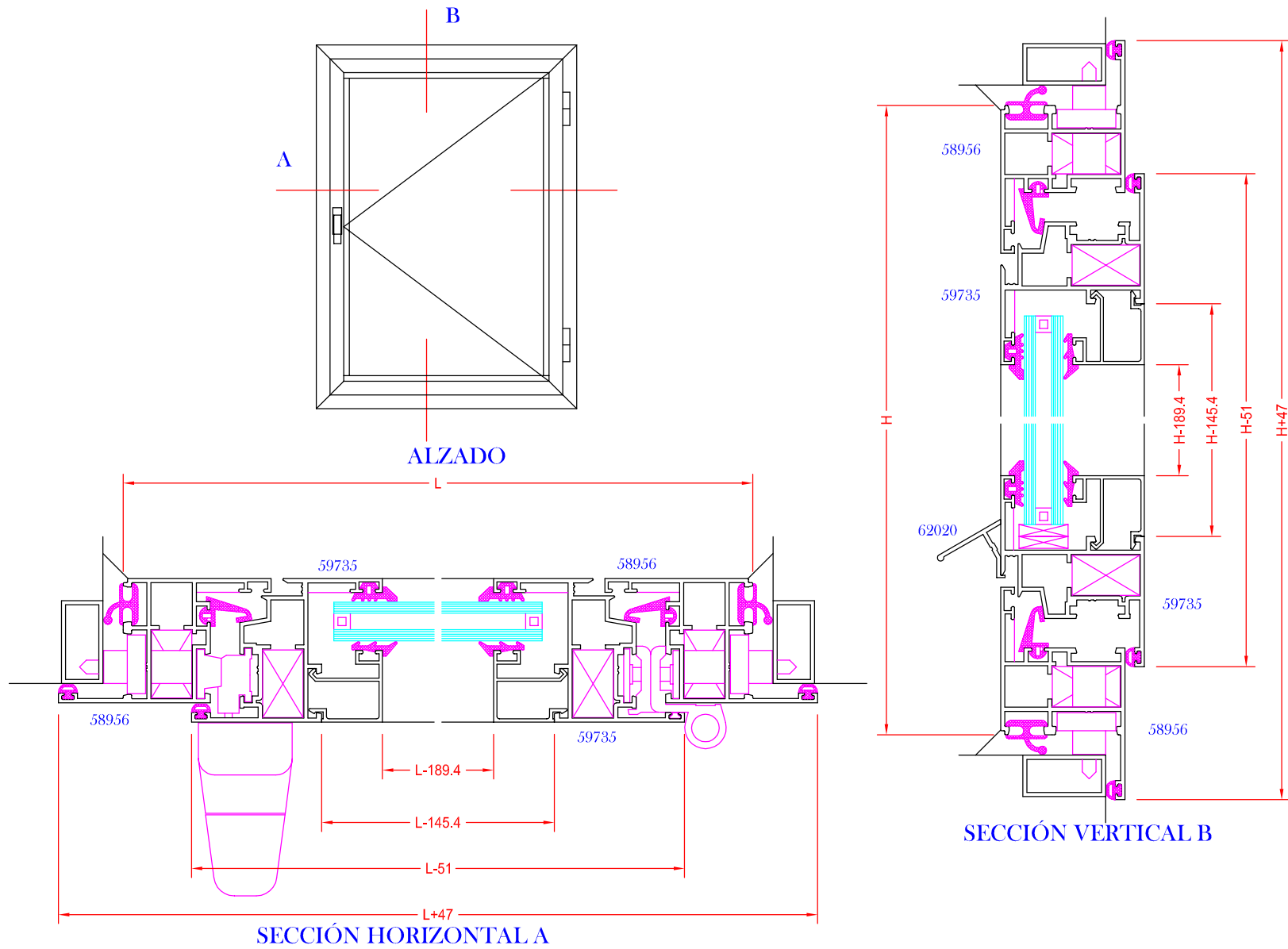

SISTEMAS integra

VENTANA ABISAGRADA DE UNA HOJA CON TAPAJUNTAS INCORPORADO

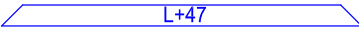

## VENTANA ABISAGRADA DE UNA HOJA CON TAPAJUNTAS INCORPORADO

SERIE abisagrada a45

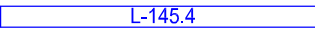
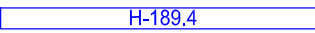
LONGITUDES DE CORTE	REFERENCIA	DENOMINACIÓN	UDS.	LONGITUD DE CORTE mm.
	58956	Cerco ventana con tapajuntas (horizontal)	2	
	58956	Cerco ventana con tapajuntas (vertical)	2	
	59735	Hoja ventana (horizontal)	2	
	59735	Hoja ventana (vertical)	2	
	-	Junquillo (horizontal)	2	
	-	Junquillo (vertical)	2	
	58951	Pletina falleba	-	
	62020	Verteaguas (opcional)		

ACCESORIOS Y BURLETES	REFERENCIA	DENOMINACIÓN	UDS.	DIMENSIÓN
	HA0306	Escuadra emsamble 25x15	8	
	HA1270	Escuadra alineamiento	8	
	HA1250	Distanciador a muro	8/12	
	HA2357	Tapa cortavientos salida agua	2	
	HGOEMU17	Burlete estanqueidad a muro	4	2(L+14) / 2(H+14)
	HA7521	Junta central (dimensión con ángulo vulcanizado)	4	2(L-133) / 2(H-133)
	HA7541	Ángulo vulcanizado	4	
	HGOJA45	Burlete tapajuntas	4	2(L+47) / 2(H+47)
	HGOJA45	Burlete hoja	4	2(L-51) / 2(H-51)
	HGOGA_	Junta exterior acristalamiento	4	2(L-169) / 2(H-169)
	HGOCL_	Junta interior acristalamiento	4	2(L-169) / 2(H-169)
	HA0120 HSA2000	Bisagra reversible	2/3	
	HS86011	Cremona Laminex	1	
	HA2114	Terminal pletina falleba	2	
	HA1322	Encuentro	2	
	HA2387	Bloque transmisión	1	

\*HSA3001: Incluye en un kit HA2114, HA1322, HA2387

VENTANA DOS HOJAS APERTURA INTERIOR CON TAPAJUNTAS INCORPORADO Y POSTIGO

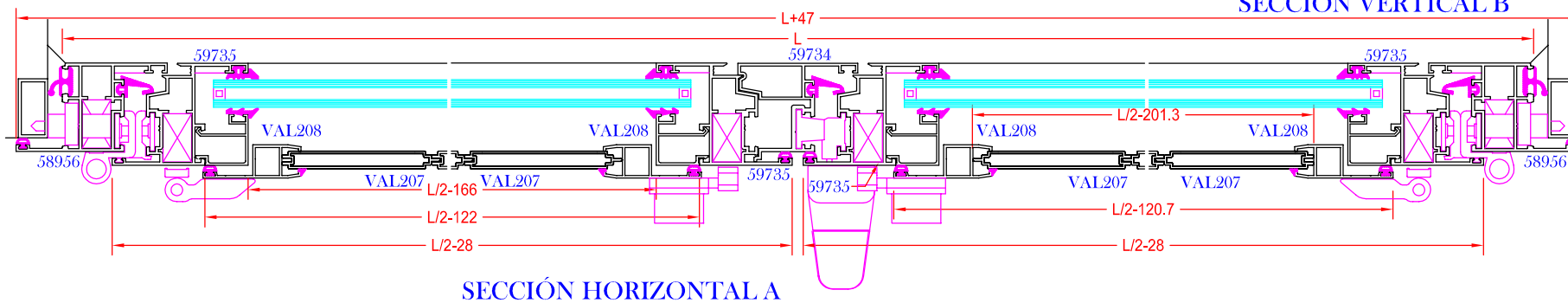
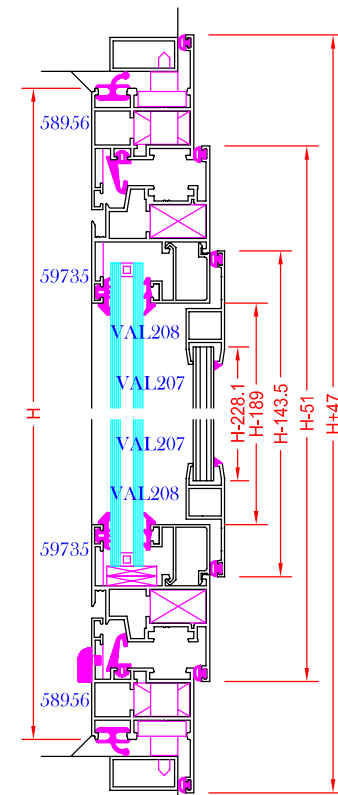
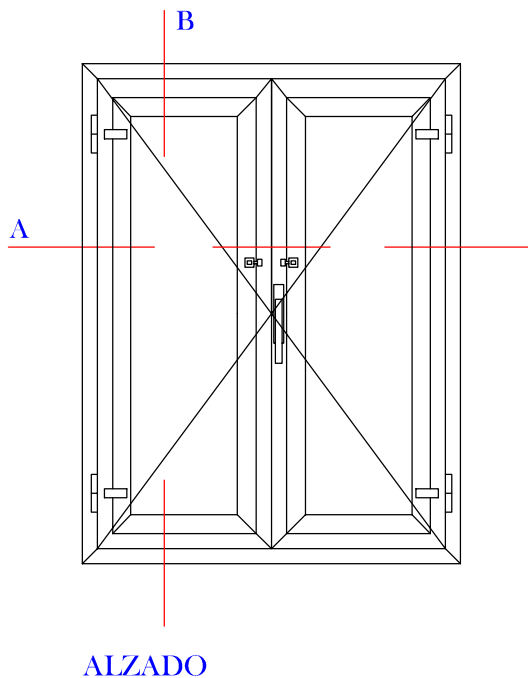

# VENTANA DOS HOJAS APERTURA INTERIOR CON TAPAJUNTAS INCORPORADO Y POSTIGO

LONGITUDES DE CORTE	REFERENCIA	DENOMINACIÓN	UDS.	LONGITUD DE CORTE mm.
	58956	Cerco ventana con tapajuntas (horizontal)	2	L+47
	58956	Cerco ventana con tapajuntas (vertical)	2	H+47
	59735	Hoja ventana (horizontal)	4	L/2-28
	59735	Hoja ventana (vertical)	4	H-51
	59734	Inversor	1	H-117.2
	-	Junquillo (horizontal)	4	L/2-122
	-	Junquillo (vertical)	4	H-189
	58951	Pletina falleba	-	
	62020	Vierteaguas (opcional)		
**VAL208	Hoja tapaluz (horizontal)	4	L/2.120.7	
**VAL208	Hoja tapaluz (vertical)	4	H-143.5	
**VAL207	Lama panelable	(VER CUADRO)	H-228.1	

ACCESORIOS Y BURLETES	REFERENCIA	DENOMINACIÓN	UDS.	LONGITUD DE CORTE mm.
	HS86011	Cremona Laminex	1	
	*HA2387	Bloque de transmisión	1	
	*HA2337	Encuentro doble falleba	2	
	HA0120 / HSA2000	Bisagras	4/6	
	*HA2111	Pasador hoja pasiva	2	
	*HA2114	Terminal pletina falleba	2	
	HA0306	Escuadras de ensamblaje 25x15	12	
	HA1250	Distanciador a muro	8/14	
	HA1270	Escuadra de alineamiento	12	
	HA2357	Tapa cortavientos salida de agua	2	
	HA8215	Juego tapón inversor	1	
	HA630	Escuadra de refuerzo marco y hoja	12	
	HA0210	Junta central marco (dimensión con ángulo vulcanizado)	4	2(L-133) / 2(H-133)
	HA0210	Junta central inversor	1	H-117.2
	HA0225	Ángulo vulcanizado	4	
	HGOJA45	Burlete perimetral muro	4	2(L+47) / 2(H+47)
	HGOJA45	Burlete perimetral hoja	8	4(L/2-28) / 4(H-51)
	HGOGA_ / HGOCL_	Burlete acristalamiento	8/8	
**HSA2050_	Bisagra postigos	4		
**HSA4711	Escuadra de ensamblaje 12x14	8		
**HSA3180_	Cierre de presión mini	2		
**HT1261	Burlete perimetral postigo	8	4(L/2-122) / 4(H-143.5)	

\* Elementos incluidos en el kit HSA3002.  
 \*\* Accesorios y perfiles de postigo.

## Nº LAMAS PANELABLES

L/2-201.3 HUECO DE LUZ	Nº LAMAS VAL207
157-234	3
234-310	4
310-386	5
386-462	6
462-538	7
538-615	8
615-691	9
691-767	10
767-843	11
843-919	12
919-996	13
996-1072	14
1072-1148	15
1148-1224	16
1224-1300	17
1300-1377	18
1377-1453	19
1453-1529	20

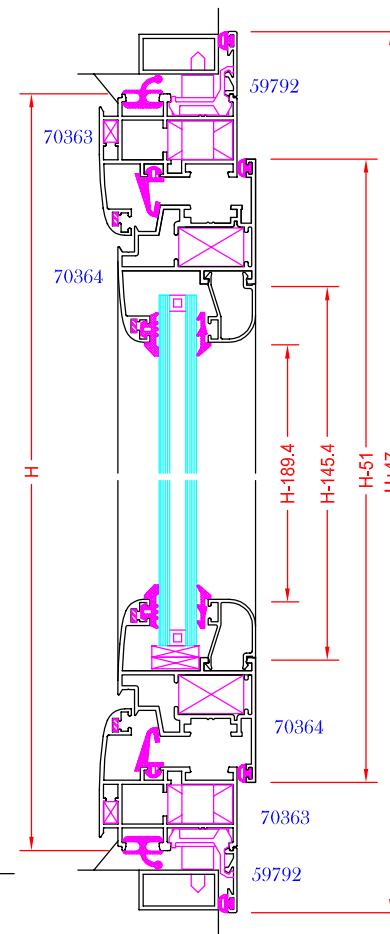
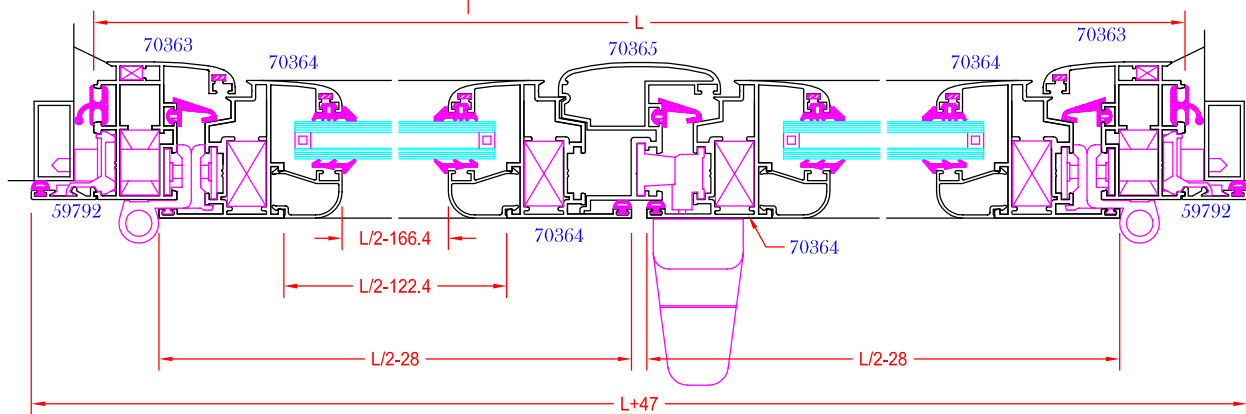
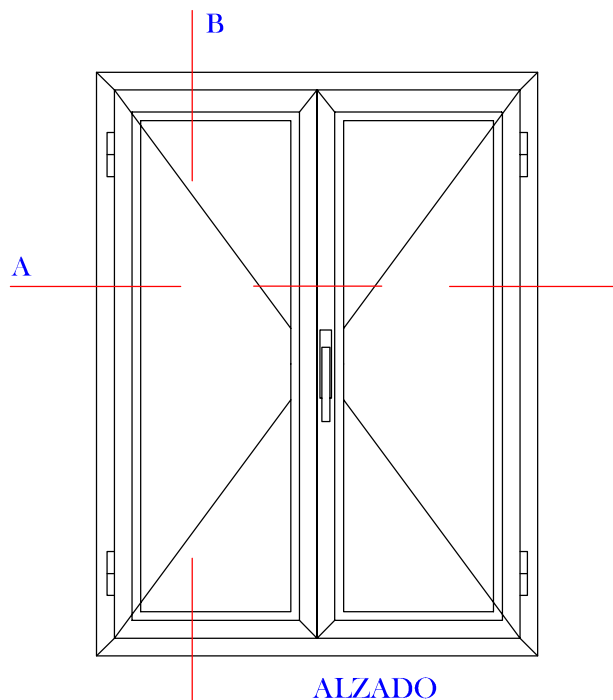

SERIE abisagrada a45

VENTANA DOS HOJAS CURVAS APERTURA INTERIOR CON TAPAJUNTAS CLIPADO



## VENTANA DOS HOJAS CURVAS APERTURA INTERIOR CON TAPAJUNTAS CLIPADO

**SERIE abisagrada a45**

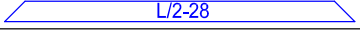
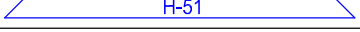
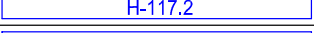
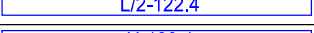
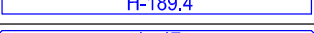
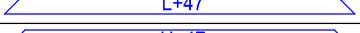
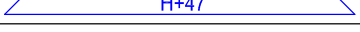
LONGITUDES DE CORTE	REFERENCIA	DENOMINACIÓN	UDS.	LONGITUD DE CORTE mm.
	70363	Cerco curvo (horizontal)	2	
	70363	Cerco curvo (vertical)	2	
	70364	Hoja curva ventana (horizontal)	4	
	70364	Hoja curva ventana (vertical)	4	
	70365	Inversor	1	
	-	Junquillo (horizontal)	4	
	-	Junquillo (vertical)	4	
	59792	Tapajuntas horizontal	1	
	59792	Tapajuntas vertical	2	
	58951	Pletina falleba		
	62020	Vierteaguas (opcional)		

ACCESORIOS Y BURLETES	REFERENCIA	DENOMINACIÓN	UDS.	DIMENSIÓN
	HA0306	Escuadra ensamblado 25x15	12	
	HA0359	Escuadra alineamiento	12	
	HA1250	Distanciador a muro	8/14	
	HA2357	Tapa cortavientos salida agua	2	
	HA1902	Juego tapas nudo central	1	
	HA630	Escuadra de refuerzo	4	
	HGOEMU17	Burlete estanqueidad a muro	4	$2(L+14) / 2(H+14)$
	HA7521	Junta central (dimensión con ángulo vulcanizado)	4	$2(L-133) / 2(H-133)$
	HA7521	Junta central (en inversor 70365)	1	$1(H-117)$
	HA7541	Ángulo vulcanizado	4	
	HGOJA45	Burlete perimetral muro	4	$2(L+47) / 2(H+47)$
	HGOJA45	Burlete perimetral de hoja	8	$4(L/2-28) / 4(H-51)$
	HGOGA_	Junta exterior acristalamiento	8	$4(L/2-146) / 4(H-169)$
	HGOCL_	Junta interior acristalamiento	8	$4(L/2-146) / 4(H-169)$
	HA1254	Clip fijación tapajuntas	10/18	
	HA0120 / HSA2000	Bisagra reversible	4/6	
	HS86011	Cremona Laminex	1	
	HA2114	Terminal pletina falleba	2	
	HA2337	Encuentro doble	2	
	HA2111	Pasador hoja pasiva	2	
	HA2387	Bloque transmisión	1	



\*HSA3001: Incluye en un kit HA2114, HA2337, HA2111, HA2387

PUERTA UNA HOJA APERTURA INTERIOR

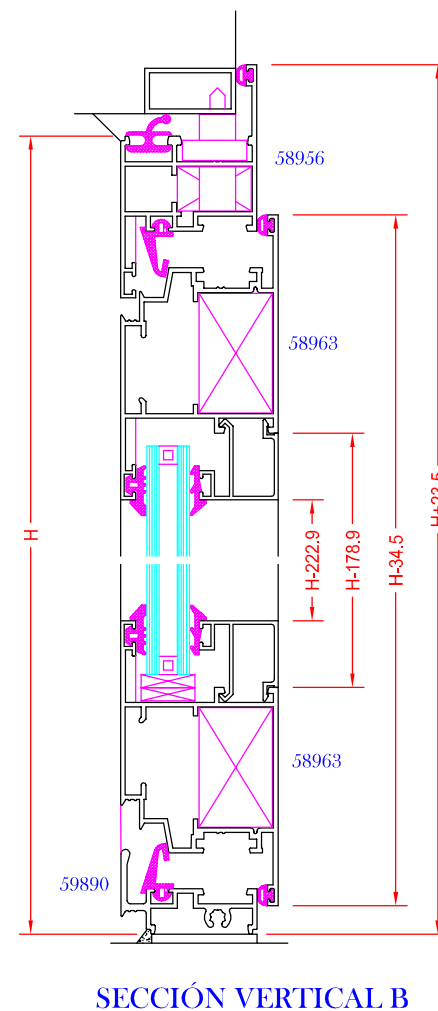
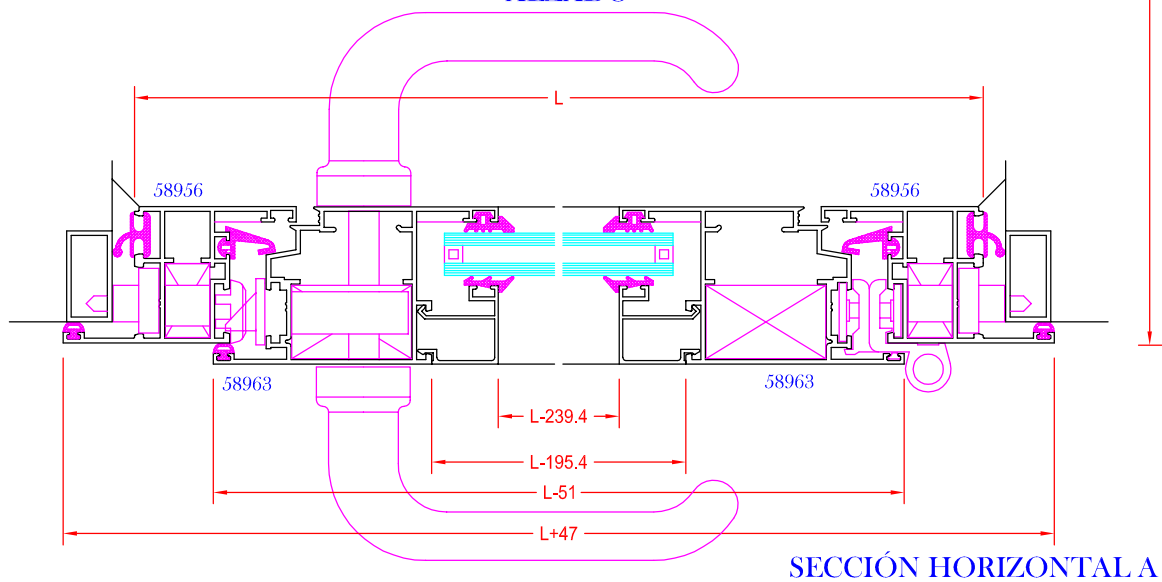
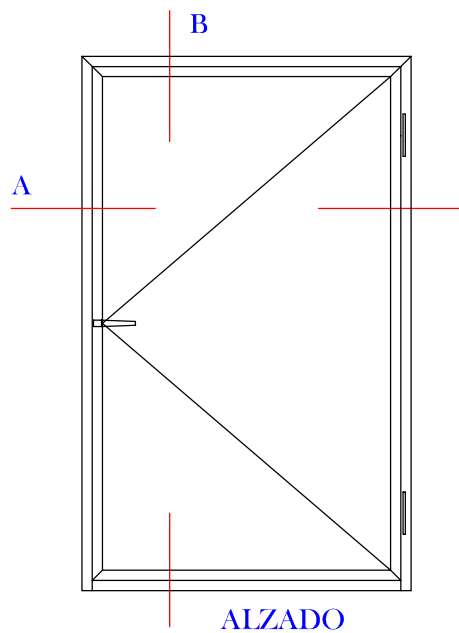

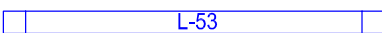
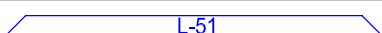
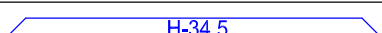
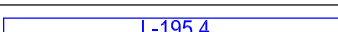
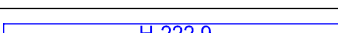

## PUERTA UNA HOJA APERTURA INTERIOR

LONGITUDES DE CORTE	REFERENCIA	DENOMINACIÓN	UDS.	LONGITUD DE CORTE mm.
	58956	Cerco con tapajuntas (horizontal)	1	 L+47
	58956	Cerco con tapajuntas (vertical)	2	 H+23.5
	59890	Peana balconera (horizontal)	1	 L-53
	58963	Hoja puerta (horizontal)	2	 L-51
	58963	Hoja puerta (vertical)	2	 H-34.5
	-	Junquillo hoja (horizontal)	2	 L-195.4
	-	Junquillo hoja (vertical)	2	 H-222.9

ACCESORIOS Y BURLETES	REFERENCIA	DENOMINACIÓN	UDS.	DIMENSIÓN
	HA0306	Escuadra mecánica 25 x 15	2	
	HA0308	Escuadra mecánica 25 x 40	4	
	HA1270	Escuadra alineamiento	6	
	HA1250	Distanciador a muro	8/14	
	HGOEMU17	Burlete estanqueidad a muro	3	$1(L+14) / 2(H+7)$
	HA7521	Junta central (dimensión con ángulo vulcanizado)	4	$2(L-133) / 2(H-116)$
	HA7541	Ángulo vulcanizado	4	
	HGOJA45	Burlete de tapajuntas	3	$1(L+47) / 2(H+24)$
	HGOJA45	Burlete perimetral hoja	4	$2(L-51) / 2(H-34)$
	HGOGA_	Junta exterior acristalamiento	4	$2(L-219) / 2(H-202)$
	HGOCL_	Junta interior acristalamiento	4	$2(L-219) / 2(H-202)$
	HA0271	Bisagra tres palas	3	
	-	Conjunto cerradura	1	
HA2462	Juego de manillas	1		

SERIE ABISAGRANA 445

PUERTA DOS HOJAS CON ZÓCALO APERTURA EXTERIOR

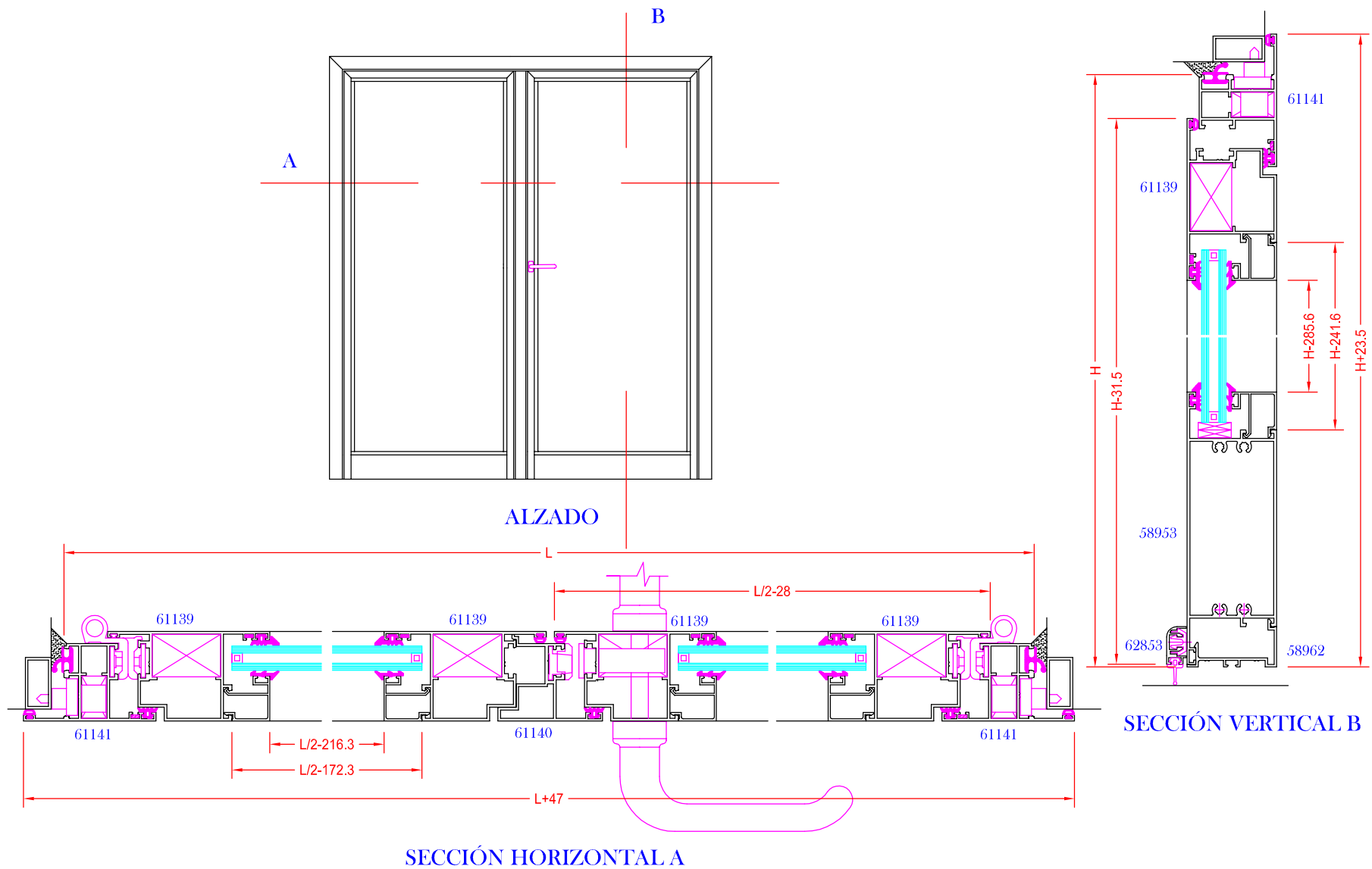

## PUERTA DOS HOJAS CON ZÓCALO APERTURA EXTERIOR

LONGITUDES DE CORTE	REFERENCIA	DENOMINACIÓN	UDS.	LONGITUD DE CORTE mm.
	61141	Cerco con tapajuntas (horizontal)	1	L+47
	61141	Cerco con tapajuntas (vertical)	2	H+23,5
	61139	Hoja puerta (horizontal)	2	L/2-28
	61139	Hoja puerta (vertical)	4	H-31,5
	58953	Travesaño 158,5 x 52	2	L/2-162,3
	58962	Tapa inferior para 58953	2	L/2-162,3
	61140	Inversor hoja	1	H-66,5
	62853	Perfil cierre con goma barrido	2	L/2-25,5
	-	Junquillo (horizontal)	4	L/2-172,3
-	Junquillo (vertical)	4	H-285,6	

ACCESORIOS Y BURLETES	REFERENCIA	DENOMINACIÓN	UDS.	DIMENSIÓN
	HA0271	Bisagra tres palas apertura exterior	4/6	
	HA0306	Escuadra de ensamblar 25 x 15	2	
	HA0308	Escuadra de ensamblar 25 x 40	4	
	HA0359	Escuadra de alineamiento	6	
	HA1250	Distanciador a muro	10/16	
	HA2174	Pasador puerta hoja pasiva	2	
	HA1904	Tapón nudo central (juego)	1	
	HA1322	Cerradero simple	1	
	HA1326	Placa suelo	1	
	HA2462	Juego manillas puerta	1	
	HGOEMU17	Burlete estanqueidad a muro	3	1(L+14) / 2(H+7)
	HGOJA45	Junta estanqueidad de hoja	6	2(L/2-28) / 4(H-31,5)
	HGOJA45	Junta estanqueidad tapajuntas	3	1(L+47) / 2(H+23,5)
	HA7531	Junta estanqueidad cerco	4	1(L-84) / 3(H-42)
	HA154K	Burlete de barrido inferior	2	L/2-25,5
	HA1249	Clip fijación perfil 62853	6/8	
	HGOGA_	Junta acristalamiento externo	8	4(L/2-196) / 4(H-265)
	HGOCL_	Junta acristalamiento interior	8	4(L/2-196) / 4(H-265)
	-	Juego cerradura	1	

SERIE abisagrana a45

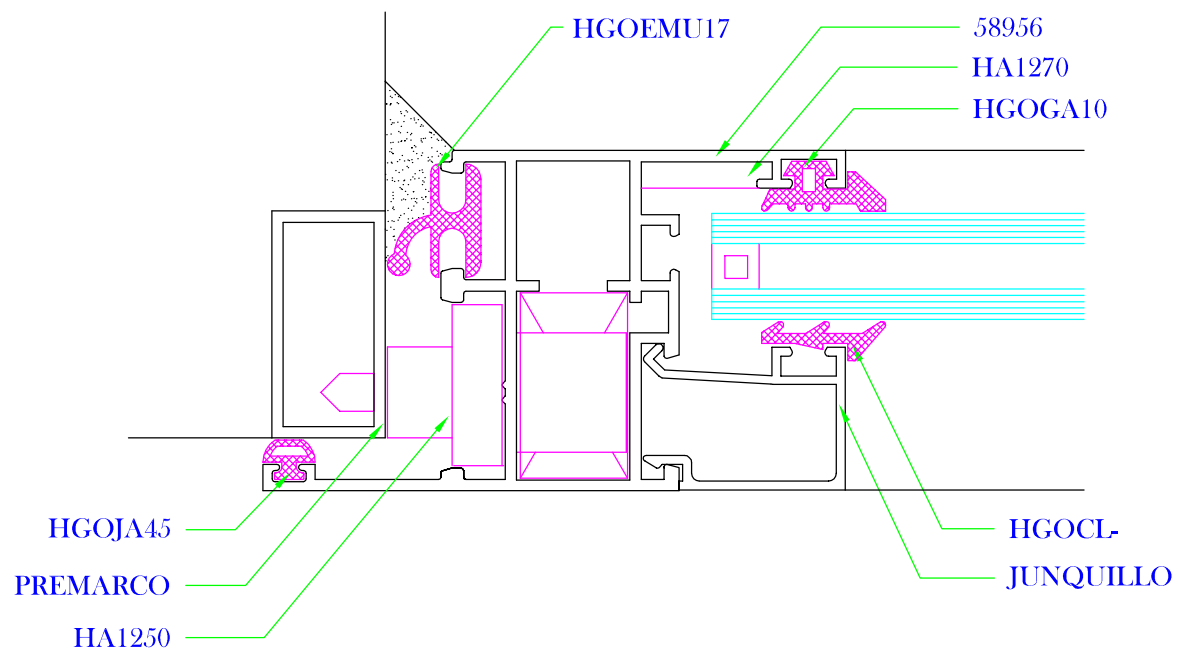

SECCIÓN LATERAL MARCO FIJO

DETALLES EN SECCIÓN

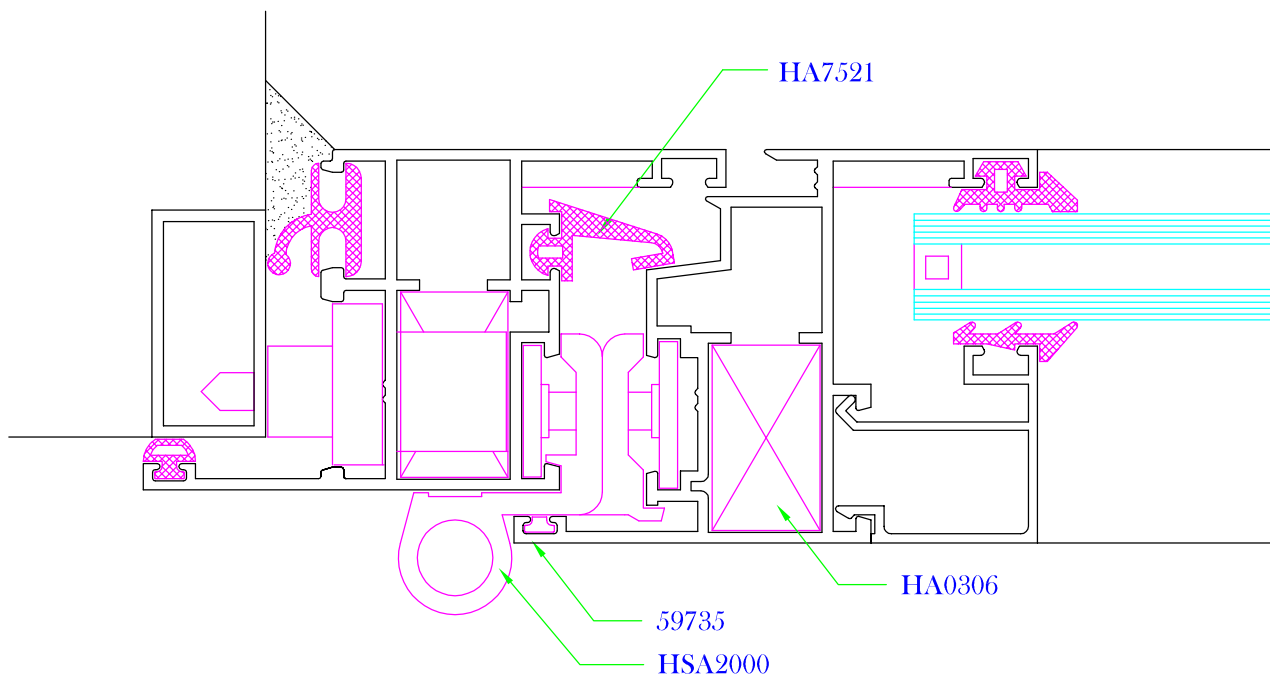

SECCIÓN LATERAL VENTANA

SERIE abisagrada a45

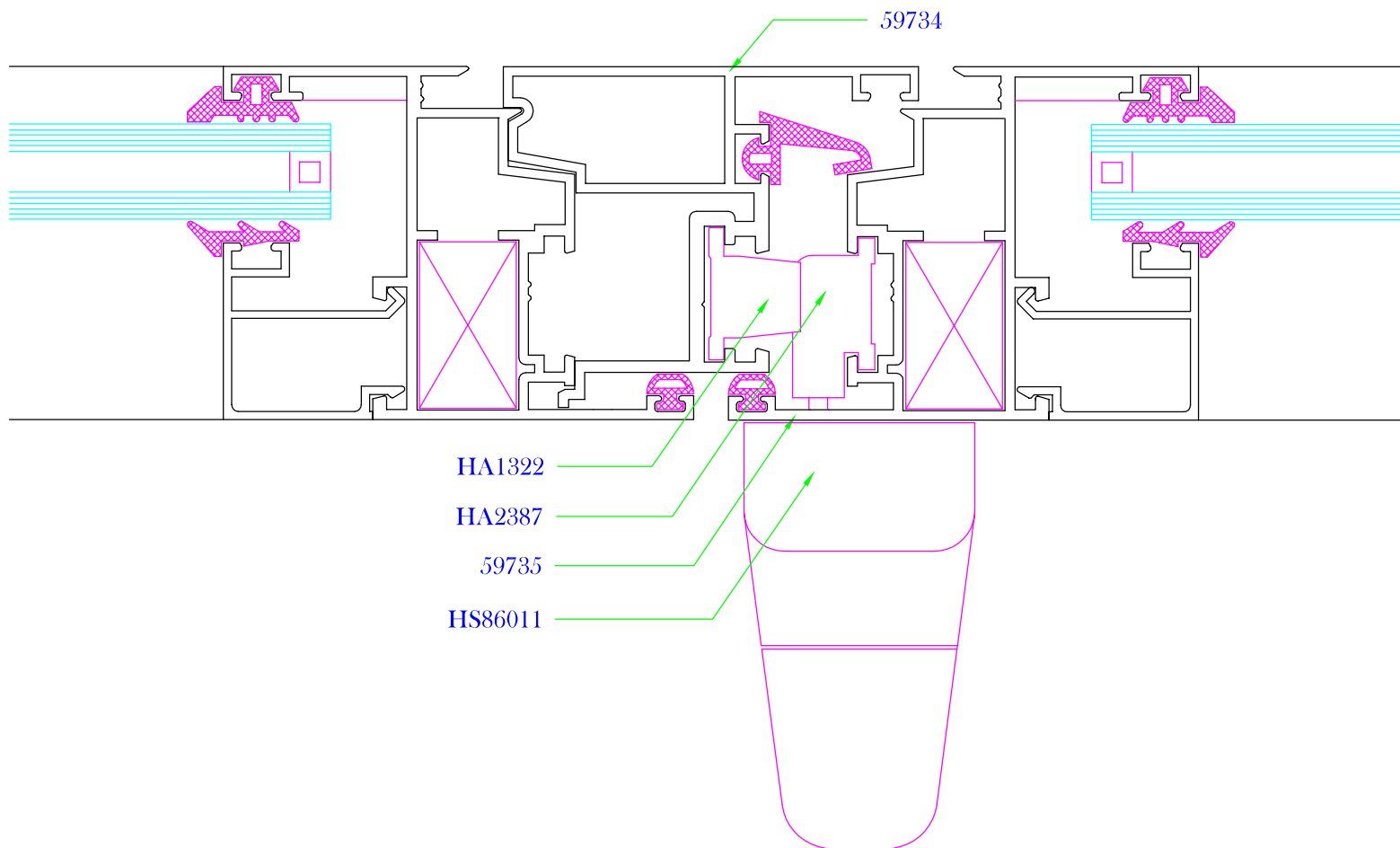

SECCIÓN CENTRAL VENTANA DE 2 HOJAS

DETALLES EN SECCIÓN

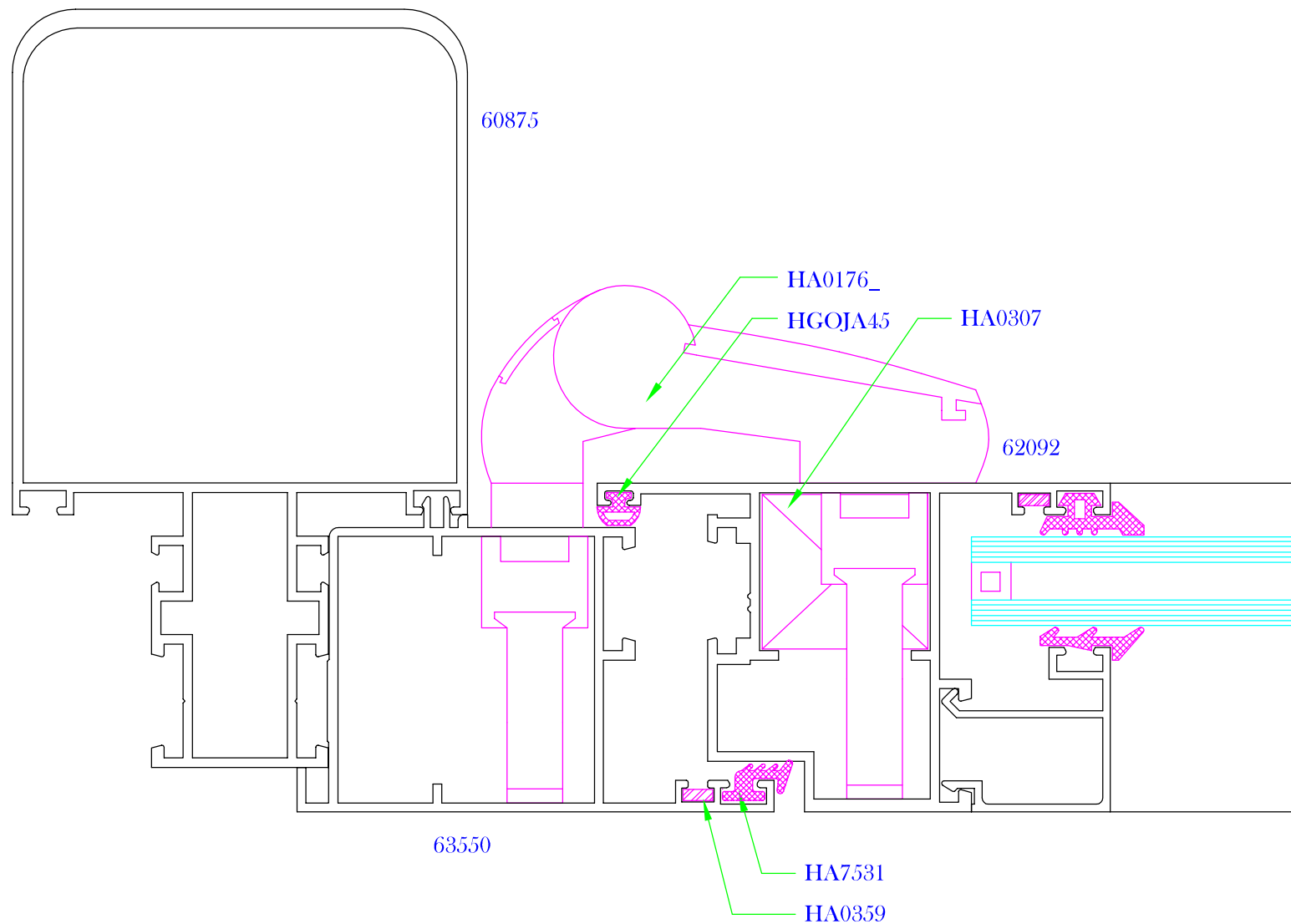

SERIE abisagrada a45

INVERSOR CON BISAGRA EXTERIOR

SERIE abisagrada a45

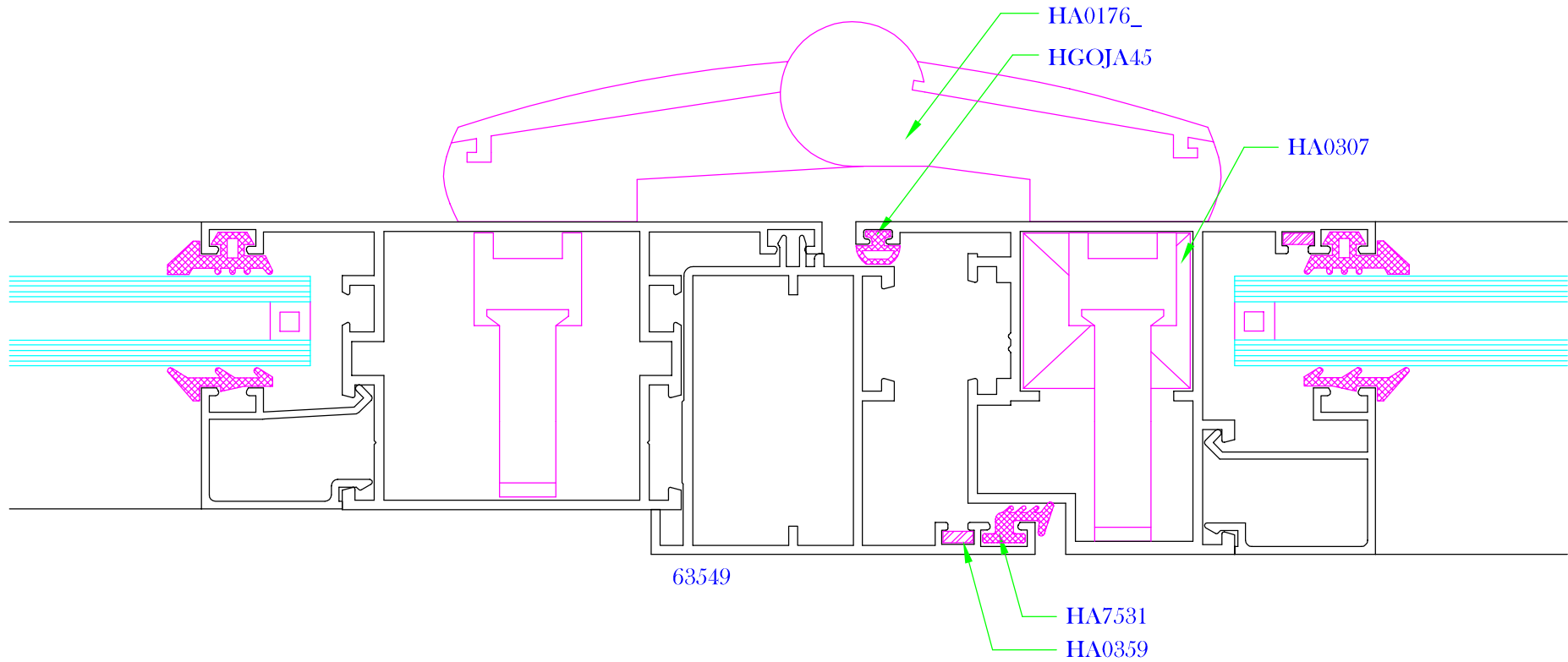

INVERSOR CON BISAGRA EXTERIOR



# DETALLES EN SECCIÓN

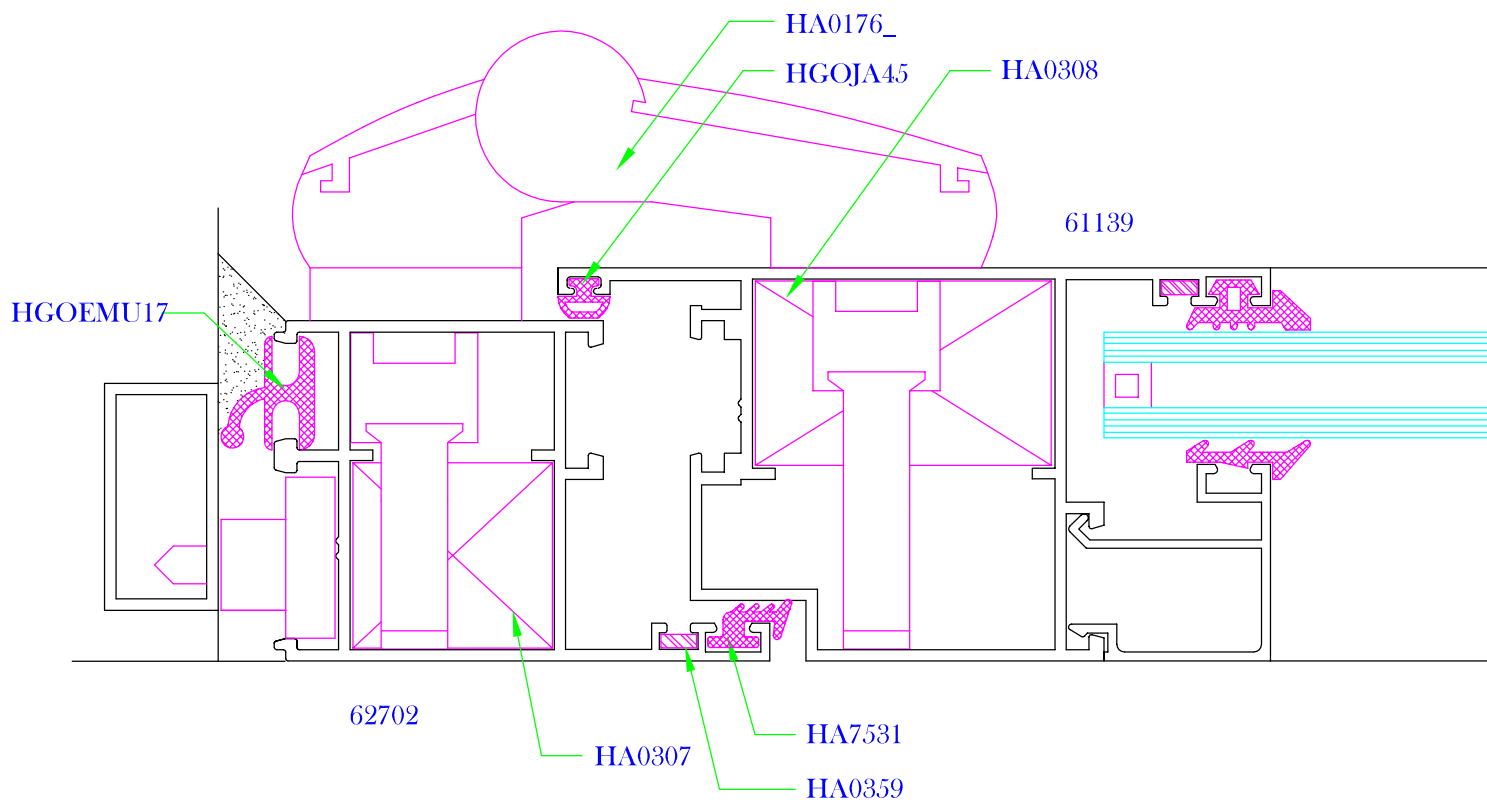

NUDO ESTÀNDAR BISAGRA EXTERIOR

SERIE abisagrada a45

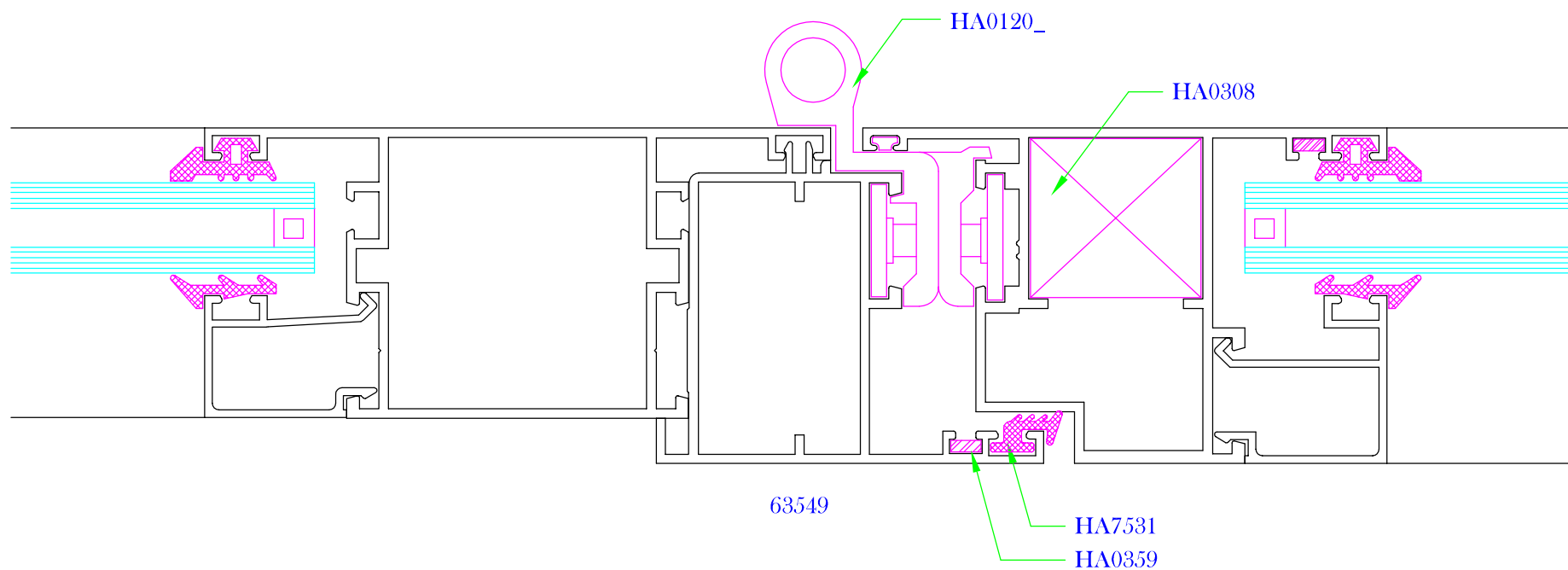

INVERSOR PARA CAMBIO DE APERTURA