

exo
lighting

decorative
indoor ∞

2011

GRUPO|NOVOLUX^{LIGHTING}

GRUPO | **NOVOLUX** LIGHTING

Este catálogo no constituye oferta en firme de los productos, para más información diríjanse a:
This catalogue does not constitute a definite offer for sale of any of the products. For further information please contact:
Ce catalogue ne fournit pas une offre définitive des produits, pour plus d'informations adressez-vous à:
O presente catálogo não constitui uma oferta firme dos produtos, para mais informações contacte:

GRUPO GESTIÓN INTEGRAL NOVOLUX INTERNACIONAL, SL
C/ Ramón Berenguer, 8 (Polígono Industrial Can Vinyals)
08130 Sta. Perpetua de la Mogoda - BARCELONA - España
ESPAÑA - PORTUGAL: Tel +34 93 274 52 52
FRANCE: 0800 918 906
REST OF THE WORLD: Tel +34 93 516 20 05
Fax +34 93 346 37 51 / 93 311 45 46 - info@gruponovolux.com
www.gruponovolux.com





exo
lighting

lighting from Barcelona



Colecciones / Collections / Collections / Coleções

Kasha

 p. 76
 p. 133





Britta

 p. 77
  p. 178



Book

 p. 70
 p. 204



new

Tess

 p. 98
  p. 168



Cloé

 p. 74
 p. 144
  p. 192



new

Valan

 p. 74
 p. 148
 p. 190



Aliya

 p. 48
 p. 130



Colecciones / Collections / Collections / Coleções

A TU ESTILO

 p. 82
 p. 80
 p. 134
  p. 170



Gina

 p. 92
  p. 214







Oval

 p. 90
  p. 212







Eda

 p. 95
  p. 210



Firenze

 p. 86
  p. 208

































Superficie pared y/o techo / Surface wall and/or ceiling fixtures



























Mur et/ou plafond / Saliente Parede e/ou Teto

Fred 22 	Siker 24 	Lari 26 	Clear 28 	Atlas 29 
Borgo 30 	Carpi 31 	Cubi 32 	Brick 34 	Denar 36 
Nucir 37 	Shadow 38 	Iona 40 	Rett 42 	Deneb 44 
Cluny 44 	Remy 46 	Sheibe 47 	Iv 47 	Aliya 48 
Ribbon 50 	Pyramid 52 	Espiga 52 	Circus 54 	Vollmond 54 
Finn 56 	Aurora 56 	Menkar 57 	Toliman 58 	Toscana 59 















Superficie pared y/o techo / Surface wall and/or ceiling fixtures Mur et/ou plafond / Saliente Parede e/ou Teto

<p>Dorés 60</p> <p>LED</p> 	<p>Dirk 61</p> <p>LED</p> 	<p>Lector 61</p> <p>LED</p> 	<p>Diden 62</p> <p>LED</p> 	<p>Spot 62</p> <p>LED</p> 
<p>Baltic 64</p> <p>LED USB</p> 	<p>Lesing 66</p> <p>LED</p> 	<p>Elf 67</p> <p>LED</p> 	<p>Leiden 68</p> <p>new LED USB</p> 	<p>Olvas 69</p> <p>LED</p> 
<p>Julia 70</p> <p>LED</p> 	<p>Book 70</p> <p>LED</p> 	<p>Lore 72</p> <p>LED</p> 	<p>Tabel 72</p> <p>LED</p> 	<p>Cloé 74</p> 
<p>Valan 74</p> <p>NEW</p> 	<p>Elke 75</p> 	<p>Kasha 76</p> 	<p>Britta 77</p> 	<p>Easy 78</p> 
<p>A TU ESTILO 80</p> 	<p>Nuno 83</p> <p>NEW</p> 	<p>Bay 84</p> 	<p>Monnet 85</p> 	<p>Firenze 86</p> <p>new LED USB</p> 
<p>Oval 90</p> 	<p>Gina 92</p> 	<p>Verona 94</p> 	<p>Bearn 95</p> 	<p>Eda 95</p> 

Colgantes / Pendant / Suspensions / Suspensão

<p>Tess 98</p> <p>NEW</p>  <p>Ø400</p>	<p>Selma 100</p> <p>NEW</p>  <p>Ø140</p>	<p>Selma 102</p> <p>NEW</p>  <p>Ø600</p>	<p>Fiji 104</p> <p>NEW</p>  <p>Ø230</p>	<p>Vimet 106</p> <p>new</p>  <p>Ø450</p>	
<p>Cuska 108</p> <p>new</p>  <p>Ø260 Ø440</p>	<p>Beton 110</p>  <p>Ø150</p>	<p>Baguet 112</p>  <p>Ø300 Ø160</p>	<p>Elga 114</p>  <p>Ø200</p>	<p>Flavia 116</p>  <p>Ø300</p>	
<p>Sira 118</p>  <p>Ø500</p>	<p>Dora 120</p>  <p>Ø320</p>	<p>Eyra Glass 121</p>  <p>Ø250</p>	<p>Estikla 122</p>  <p>Ø280</p>	<p>Brenda 124</p>  <p>Ø300</p>	
<p>Cupertino 125</p> <p>LED</p>  <p>Ø130</p>	<p>Gilda 126</p> <p>LED</p>  <p>Ø90</p>	<p>Alessandra 128</p>  <p>Ø370 Ø440</p>	<p>Aliya 130</p> <p>LED</p>  <p>Ø400</p>	<p>Fred 132</p>  <p>Ø298</p>	
<p>Kasha 133</p>  <p>Ø450</p>	<p>A TU ESTILO</p>  <p>Ø240</p>	<p>A TU ESTILO</p>  <p>Ø207</p>	<p>A TU ESTILO</p>  <p>Ø196</p>	<p>138</p> 	<p>Selene 140</p> 

Colgantes / Pendant / Suspensions / Suspensão

<p>Aprilla 142</p> 	<p>Kaira 143</p>  <p>Ø350</p>	<p>Cloé 144</p>  <p>Ø342 Ø160</p>	<p>Lírica 146</p> <p>NEW</p>  <p>Ø340</p>	<p>Valan 148</p> <p>NEW</p>  <p>Ø380</p>
<p>Lacio 148</p> <p>NEW</p>  <p>Ø450</p>	<p>Antiq 150</p>  <p>Ø356</p>	<p>Vintage 150</p>  <p>Ø375</p>	<p>Livia 152</p>  <p>Ø380</p>	<p>Tanna 154</p>  <p>Ø530</p>
<p>Olivia 156</p>  <p>Ø400</p>	<p>Bell 156</p>  <p>Ø270</p>	<p>Camila 158</p>  <p>Ø300</p>	<p>Mildred 159</p>  <p>Ø400</p>	<p>Dina 160</p> <p>LED</p>  <p>Ø200</p>
<p>Kable 12 162</p> 				

Pie y sobremesa / Floor and table lamps

Lampadaires et lampes à poser / Pé e Mesa

<p>Tess 168</p> <p>NEW</p> 	<p>A TU ESTILO</p> <p>170</p> 	<p>Lars 172</p> <p>NEW</p> 	<p>Wood 174</p> 	<p>Kara 176</p> 
<p>Britta 178</p> 	<p>Gram 180</p> 	<p>Skandia 182</p> 	<p>Spin 184</p> 	<p>Zanzibar 186</p> 
<p>Maui 188</p> 	<p>NEW</p> <p>Valan 190</p> 	<p>Cloé 192</p> 	<p>Oma 194</p> 	<p>Astrid 196</p> 
<p>LED</p> <p>Foc 198</p> 	<p>LED</p> <p>Flama 200</p> 	<p>LED</p> <p>Albero 202</p> 	<p>LED</p> <p>Study 204</p> 	<p>LED</p> <p>Book 204</p> 
<p>Iris 206</p> 	<p>Firenze 208</p> 	<p>Eda 210</p> 	<p>Oval 212</p> 	<p>Gina 214</p> 

Baño / Bath / Salle de Bain / Banho

<p>Krystal 219</p> <p>LED</p> 	<p>Dick 220</p> <p>LED</p> 	<p>Sun 220</p> <p>LED</p> 	<p>Vel 222</p> 	<p>Uveg 223</p> 
<p>Bath Classic 223</p> 	<p>Bath 224</p> 	<p>Friss 226</p> 	<p>Sheid 227</p> <p>LED</p> 	<p>Lits 228</p> <p>LED</p> 
<p>Desio 229</p> 	<p>Alf 230</p> <p>LED</p> 	<p>Dot 230</p> <p>LED</p> 	<p>Moon 231</p> <p>LED</p> 	<p>Tek 232</p> <p>LED</p> 
<p>Alin 232</p> <p>LED</p> 	<p>Tiel 234</p> <p>LED</p> 	<p>Nat-Led 236</p> <p>LED</p> 	<p>Roma 238</p> <p>LED</p> 	<p>Carpi 31</p> <p>LED</p> 

Ventiladores / Ceiling Fans / Ventilateurs / Fãs

<p>Fujil 242</p> 	<p>Cefiro 243</p> <p>LED</p> 	<p>Vento 244</p> <p>LED</p> 	<p>Marinada 246</p> <p>LED</p> 
--	--	---	--

GNX

Led strip in 250 	Led strip out 252 	Skoll 254 	Led T2 259 	Led filament 260 
Led pro 261 	G9 261 	Inel 261 	Led modul 261 	Connectors 262 
Detector 262 	Sensor 262 	Gia 263 	Himmel 264 	Track 266 
Drivers 268 				

Acabados y pictografía / Finishes and simbology Finitions et pictographie / Acabamentos e pictografia

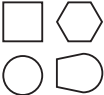
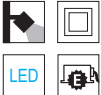
<p>Pantallas 272 Shades Abat-Jours Abajures</p> 	<p>Acabados 274 Finishes Finitions Acabamentos</p> <div style="display: flex; flex-wrap: wrap; gap: 5px;"> <div style="border: 1px solid black; padding: 2px;">01</div> <div style="border: 1px solid black; padding: 2px;">30</div> <div style="border: 1px solid black; padding: 2px;">04</div> <div style="border: 1px solid black; padding: 2px;">91</div> </div>	<p>Materiales 275 Materials Materiaux Materiais</p> 	<p>Pictografía 276 Symbology Pictographie Pictografia</p> 
---	---	---	---

Condiciones de venta / Condições de venda

281

Índice de referencias / Reference index / Index référence / Referência índice

287

Índice de familias / Family index

Index famille / Índice familia

A

A Tu Estilo	80/82/134/136 138/170/171
Albero	202
Alessandra	128/129
Alf	230
Alimentadores	268/269
Alin	232
Aliya	48/130
Antiq	150
Aprilla	142
Astrid	196
Atlas	29
Aurora	56

B

Baquet	112
Baltic	64
Bath Classic	223
Bath	224
Bay	84
Bearn	95
Bell	156
Beton	110

Book	70/204
Borgo	30
Brenda	124
Brick	34
Brick G	34
Britta	77/178

C

Camila	158
Carpi	31
Cefiro	243
Circus	54
Clear	28
Cloé	74/144/192
Cluny	44
Conectores	262
Cubi	32
Cupertino	125
Cuska	108

D

Denar	36
Deneb	44

Desio	229
Detector	262
Diden	62
Dik	220
Dina	160
Dirk	61
Dora	120
Dorés	60
Dot	230

E

Easy	78
Eda	95/210
Elfi	67
Elga	114
Elke	75
Espiga	52
Estikla	122
Eyra	121

F

Finn	56
Firenze	86/88/208
Fiyi	104
Flama	200

Flavia	116
Foc	198
Fred	22/132
Friss	226
Fujil	242

G

G9	261
Gia	263
Gilda	126
Gina	92/93/214/215
Gram	180

H

Himmel	264
--------	-----

I

Inel	261
Iona	40
Iris	206/207
Iv	47

J

Julia	70
-------	----

K

Kable 12	162/163/164/165
Kaira	143
Kara	176
Kasha	76/133
Krystal	219

L

Lacio	148
Lari	26
Lars	172
Lector	61
Led Filament	260
Led Modul	261
Led Pro	261
Led Strip In	250
Led Strip In Rgb	251
Led Strip Out	252/253
Led Strip Out Rgb	253
Led T2	259
Leiden	68
Lesing	66
Lírica	146
Lits	228

Livia	152
Lore	72

M

Marinada	246
Maui	188
Menkar	57
Mildred	159
Monnet	85
Moon	231

N

Nat Led	236
Nucir	37
Nuno	83

O

Olivia	156
Olvas	69
Oma	194
Oval	90/212

P

Pyramid	52
---------	----

R

Remy	46
Rett	42
Ribbon	50
Roma	238

S

Selene	140
Selma	100/102
Sensor	262
Shadow	38
Sheibe	47
Sheid	227
Siker	24
Sira	118
Skandia	182
Skoll	254/255/256/257/258
Spin	184
Spot	62
Study	204
Sun	220

T

Tabel	72
Tanna	154

Tek	232
Tess	98/168
Tiel	234
Toliman	58
Toscana	59
Track	266/267

U

Uveg	223
------	-----

V

Valan	74/148/190
Vel	222
Vento	244
Verona	94
Vimet	106
Vintage	150
Vollmond	54

W

Wood	174
------	-----

Z

Zanzibar	186
----------	-----

THE WAY OF LIGHT

Después de 35 años de viaje,
nuestro compromiso y pasión
sigue siendo el mismo,
reflejar y dar forma
al camino de la luz.

After 35 years of journey,
our commitment and passion
remains the same,
to reflect and give shape
to the way of light.

Après 35 ans de voyage,
notre engagement et passion
sont toujours les mêmes,
réfléter et façonner
le chemin de la lumière.



LIGHTING
GRUPO|NOVOLUX

TEAMING LOCALLY, LIGHTING WORLDWIDE

Desde 1981 diseñando, desarrollando y suministrando iluminación contemporánea de calidad.

Conjuntamente con una sólida red de socios locales, hemos expandido en los últimos años nuestra presencia a todo el mundo, exportando actualmente a más de 50 países.

Since 1981 designing, developing and supplying quality and contemporary lighting fittings.

Together with a strong network of local partners, we are proud to have expanded our presence worldwide over the last years currently exporting to over 50 countries.

Depuis 1981 nous concevons, développons et fournissons des luminaires contemporains et de qualité.

À l'aide d'un solide réseau de partenaires locaux, nous sommes fiers d'avoir étendu notre présence dans le monde entier au cours des dernières années, notamment exportant actuellement vers plus de 50 pays.

*La historia de la arquitectura
es la historia de la lucha por la luz.*

*The history of architecture
is the history of the struggle for light.*

*l'histoire de l'architecture
est l'histoire de la lutte pour la lumière.*

Louis Kahn

ONE-STOP GLOBAL SUPPLIER

Con una amplia y completa gama de más de 4000 luminarias, ofrecemos un amplio espectro de aplicaciones y soluciones de iluminación para proyectos, desde contract y hospitality hasta comercial y residencial.

With an extensive and complete range of over 4000 fixtures, we offer a wide spectrum of lighting applications and solutions for projects, from contract and hospitality to retail and residential.

Avec une gamme vaste et complète de plus de 4000 références, nous disposons d'un large éventail d'applications et de solutions d'éclairage pour les projets contract et hôtellerie, ainsi que commercial et résidentiels.



BEYOND LIGHTING

Una filosofía de servicio al cliente basada en el logro de la excelencia podría no ser suficiente en ocasiones, por lo que independientemente de sus necesidades de iluminación, cuente con que no escatimaremos ningún esfuerzo en resolverlas.

A customer service philosophy based on achieving excellence might not be enough sometimes, so whatever your lighting needs are, expect from us to go always the extra mile.

Une philosophie de service clientèle basée sur l'excellence, parfois peut ne pas suffire, c'est pourquoi quels que soient vos besoins en éclairage, sachez qu'on ne ménagera pas des efforts pour les résoudre.



Superficie Pared/Techo

Surface wall/ceiling
Luminaire Mur/plafond
Saliente Parede/Teto

Fred

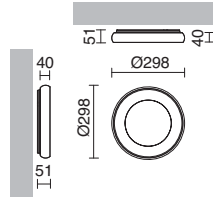

7 15A-L0125A-01

7 15A-L0125A-02

7 15A-L0125A-03

LED 25W 1850lm 3000K

Accesorio para tapar la superficie
 Accessory to cover surface
 Accessoire pour couvrir surface
 Acessório para tapar superficie

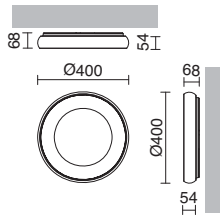
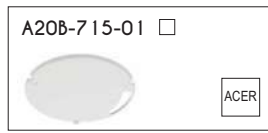

7 15B-L3135A-01

7 15B-L3135A-02

7 15B-L3135A-03

LED 35W 2940lm 3000K

Accesorio para tapar la superficie
 Accessory to cover surface
 Accessoire pour couvrir surface
 Acessório para tapar superficie





Siker

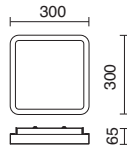

505A-L0124A-35 ●

LED 24W 1800lm 3000K*

505A-F13B7B-35 ●

2x G24q2 TC-DE 18W



505B-L0148B-35 ●

LED 48W 2800lm 3000K*

505B-F02C5B-35 ●

2x 2G11 TC-L 55W

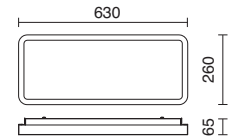

505C-L0196B-35 ●

LED 96W 7200lm 3000K*

505C-F02F8B-35 ●

3x 2G11 TC-L 36W

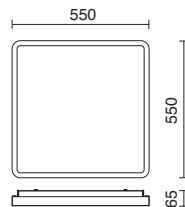

- * Disponible en 4000K
- * Available in 4000K
- * Disponible en 4000K
- * Disponivel com 4000K



Lari



LED
SAMSUNG

503A-L0140B-01

503A-L0140B-32

LED 40W 3240lm 3000K

503A-F0340B-01

503A-F0340B-32

2GX13 T5 40W

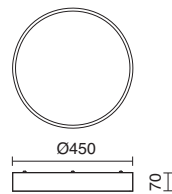

LED
SAMSUNG

503B-L0150B-01

503B-L0150B-32

LED 50W 3960lm 3000K

503B-F03G3B-01

503B-F03G3B-32

2GX13 T5 22W + 40W

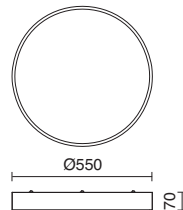



Clear



590A-L0124A-32 □

LED 24W 1800lm 3000K*

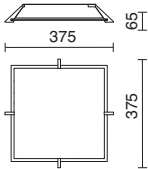

590A-F0322B-32 □

2GX13 T5c 22W



- *Disponibile en 4000K.
- *Available in 4000K.
- *Disponibile avec 4000K.
- *Disponível com 4000K.



Atlas

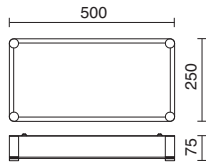

502A-F02C3B-32 □

2x 2G11 TC-L 36W



Borgo

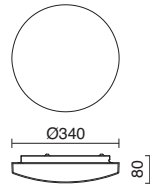

501A-G05X1A-28 □

3x E27 [Led / Fluo / Hal] max. 60W

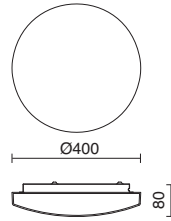

501B-G05X1A-28 □

4x E27 [Led / Fluo / Hal] max. 60W

Lámparas recomendadas / Recommended lamps
Lampes recommandées / Lâmpadas recomendadas

LED FILAMENT



pag. 260



Carpi



500A-L0115B-32 □

LED 15W 1000lm 3000K



500A-G05X1A-32 □

2x E27 [Led / Fluo / Hal] 2x 23W

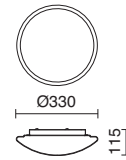

Lámparas recomendadas / Recommended lamps
Lampes recommandées / Lâmpadas recomendadas

LED FILAMENT



pag. 260



Cubi



426B-G21X1A-01

426B-G21X1A-02

GU10 [Led / Hal] max. 50W

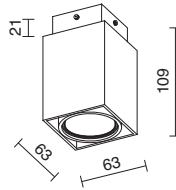

Lámpara recomendada
Recommended lamp
Lampe recommandée
Lâmpada recomendada

LED PRO



pag. 261

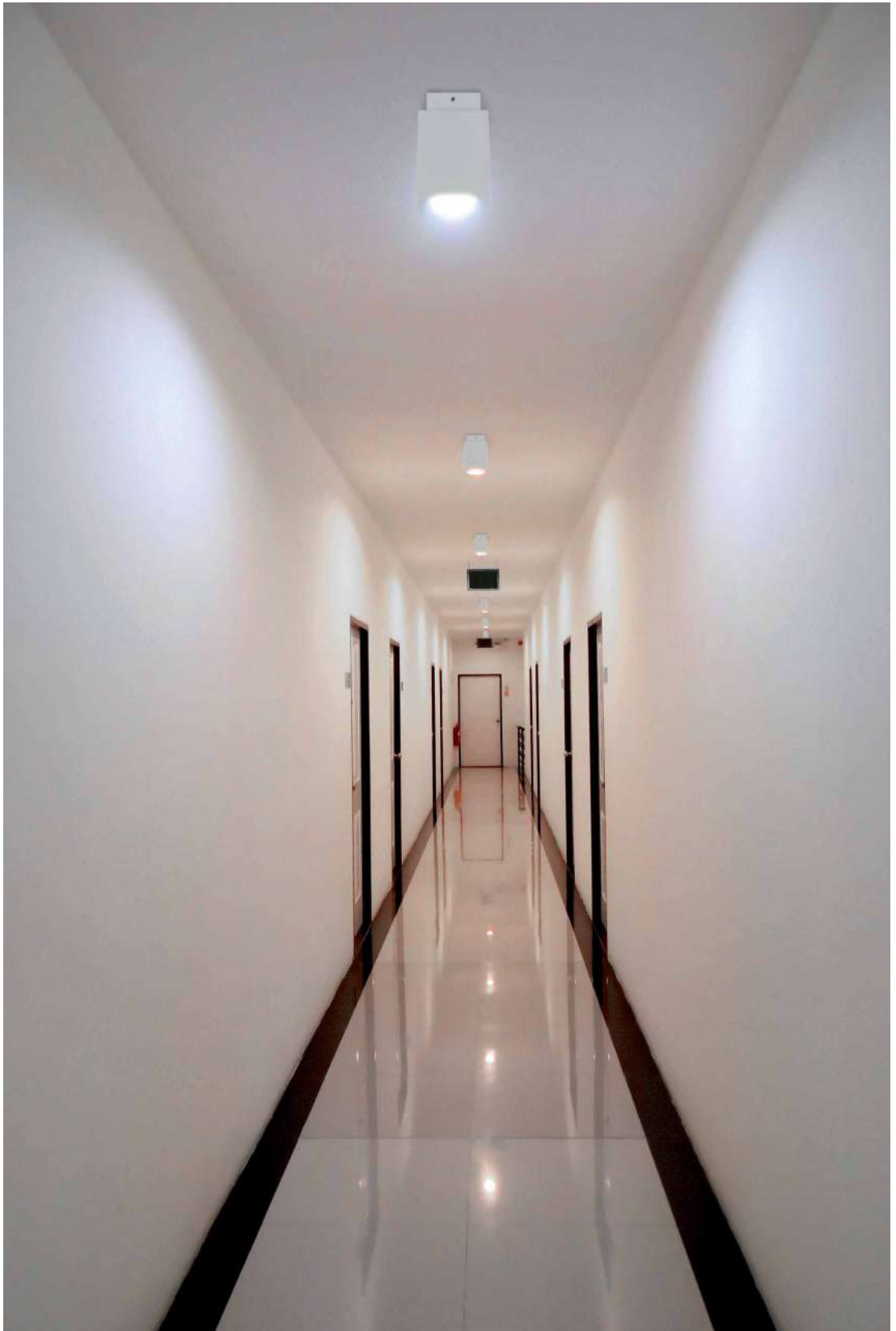

Brick

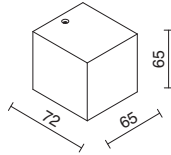

412A-LO103B-40

LED 3W 165lm 3000K

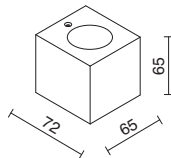

412B-LO1E2B-40

LED 2x 3W 2x 165lm 3000K

Brick G

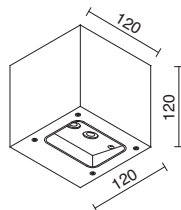

412B-LO1F1B-01

412B-LO1F1B-40

LED 2x 5W 2x 325lm 3000K



Denar



711A-L0106A-01 □

LED 2x 2W 2x 160lm 3000K

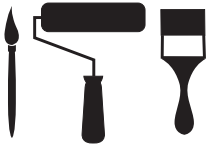
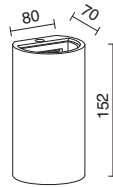

Se recomienda el uso de papel de lija en la superficie antes de aplicar pintura para pared.

It is recommended to sand with fine grain sandpaper the surface of the luminaire before painting it with the wall paint.

Avant d'appliquer la peinture murale, poncer la surface du luminaire avec du papier de verre à grains fins.

Recomenda-se o uso de lixa na superfície antes da pintura com tinta de parede.



Nucir

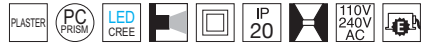

713A-L0106A-01 □

LED 2x 2W 2x 160lm 3000K

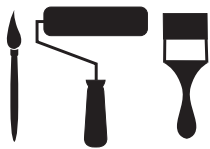
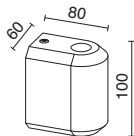

Se recomienda el uso de papel de lija en la superficie antes de aplicar pintura para pared.

It is recommended to sand with fine grain sandpaper the surface of the luminaire before painting it with the wall paint.

Avant d'appliquer la peinture murale, poncer la surface du luminaire avec du papier de verre à grains fins.

Recomenda-se o uso de lixa na superfície antes da pintura com tinta de parede.



Shadow



419B-LO1D1B-40 

2x LED 3W 195lm 3000K

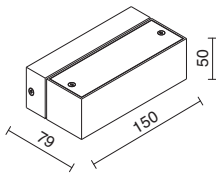



Iona

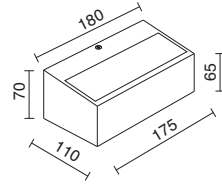

634A-L01 I3B-01

634A-L01 I3B-03

LED 13W 1200lm 3000K



634A-H35X1A-01

634A-H35X1A-03

R7s (74,9 mm) QT-DE 60W max.



634B-L01 I3B-01

634B-L01 I3B-03

LED 13W 1200lm 3000K



Rett



504C-L0105A-01

504C-L0105A-40

LED 5W 450lm 3000K



504A-L0108A-01

504A-L0108A-40

LED 8W 790lm 3000K

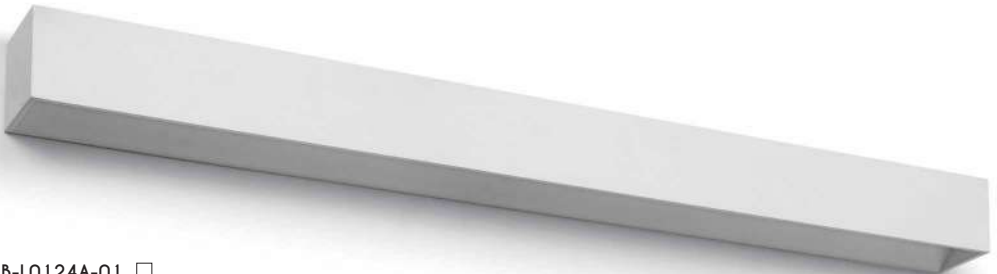
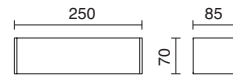

504B-L0124A-01

504B-L0124A-40

LED 24W 2270lm 3000K

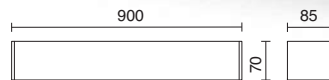



Deneb



695A-L0112A-01

695A-L0112A-32

LED 12W 1200lm 3000K

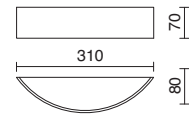

Cluny



691A-L0116A-40

LED 16W 1600lm 3000K

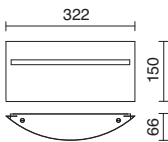



Remy



498A-L0105A-01 □

LED 5W 340lm 3000K

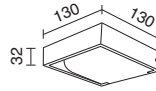

Sheibe



613A-L0105A-01 □

LED 5W 450lm 3000K

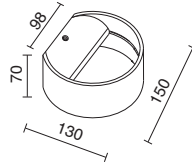

Iv



497A-L0105A-01 □

497A-L0105A-39 ■

LED 5W 310lm 3000K

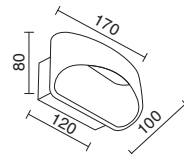

Aliya

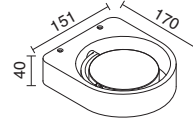

584A-L0105A-01 □

LED 5W 450lm 3000K





Ribbon



697A-L0106B-01 □

LED 6W 300lm 3000K

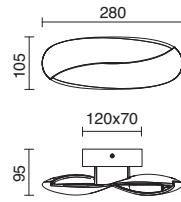



Pyramid

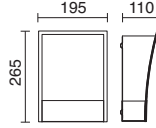

- *Disponibile en 4000K
- *Available in 4000K
- *Disponibile en 4000K
- *Disponível com 4000K



612A-L0112A-32 □

LED 12W 900lm 3000K*

612A-C05X1A-32 □

E27 [Led / Fluo / Hal] max. 60W

Lámparas recomendadas / Recommended lamps
Lampes recommandées / Lâmpadas recomendadas

LED FILAMENT



pag. 260

Espiga



693A-L0112A-35 ■

LED 12W 1200lm 3000K

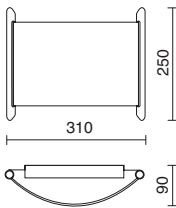



Circus



589A-L0124A-35 ◼

LED 24W 1800lm 3000K*

- ▲
- *Disponible en 4000K
- *Available in 4000K
- *Disponible en 4000K
- *Disponível com 4000K

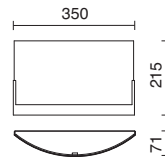

Lámparas recomendadas / Recommended lamps
Lampes recommandées / Lâmpadas recomendadas

LED FILAMENT



pag. 260

589A-G05X1A-35 ◼

E27 [Led / Fluo / Hal] max. 60W

Vollmond



626A-G05X1A-32 ◻

E27 [Led / Fluo / Hal] max. 60W

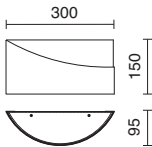

Lámparas recomendadas / Recommended lamps
Lampes recommandées / Lâmpadas recomendadas

LED FILAMENT



pag. 260



Finn



690A-L0112A-35 ■

LED 12W 1200lm 3000K

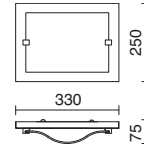

Aurora



689A-L0124A-40 ■

LED 24W 2400lm 3000K

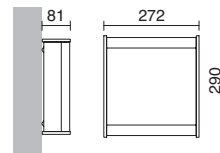

Menkar



694A-L0112A-35 ■

LED 12W 1200lm 3000K

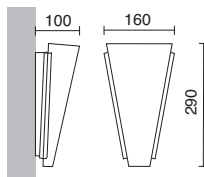

Toliman



692A-L0106A-01

692A-L0106A-32

LED 6W 600lm 3000K

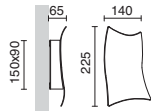

Toscana

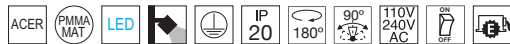

new



842A-LO103B-01

842A-LO103B-35

LED 3W 200lm 3000K

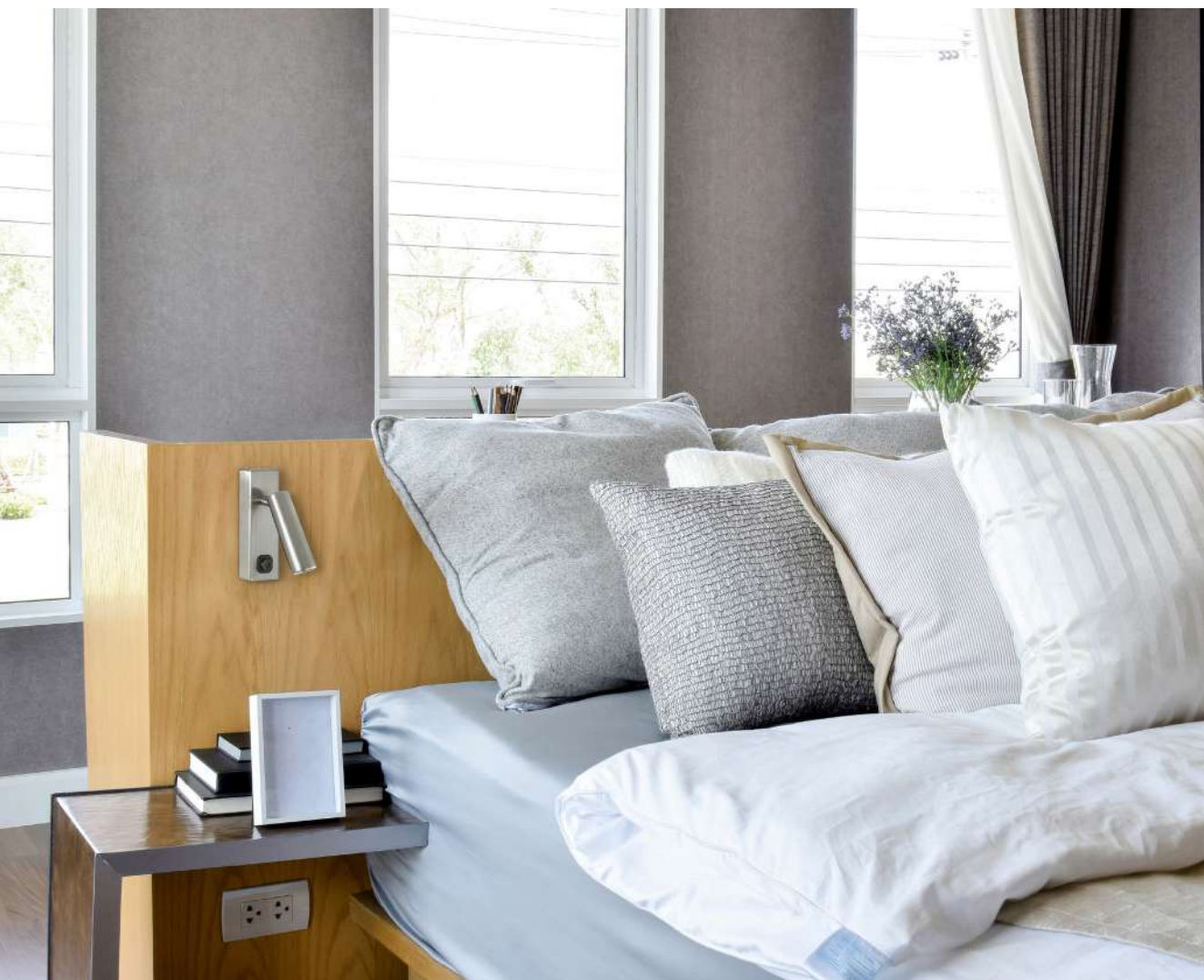
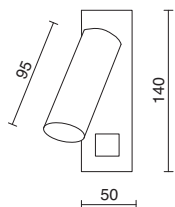

01 Blanco / White / Blanc / Branco

35 Niquel satinado / Satin nickel / Nickel satiné / Niquel acetinado

Dorés



700A-L0106b-32 □

LED 3W 200lm 3000K
+
LED 3W 200lm 3000K

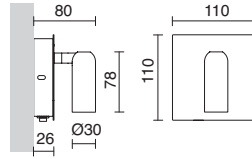

Dirk

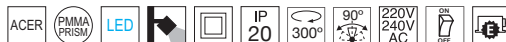

704A-LO103B-01 □

LED 3W 200lm 3000K

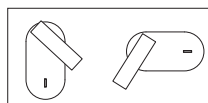
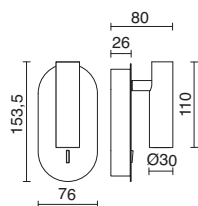

Doble posición.
Double position.
Double position.
Posição dupla.

Lector



705A-LO103B-01 □

705A-LO103B-02 ■

LED 3W 200lm 3000K

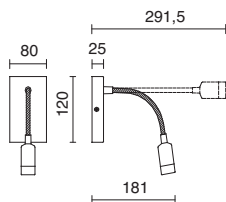

Diden

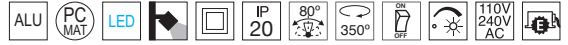

592A-L0105A-03 ■

LED 5W 330lm 3000K

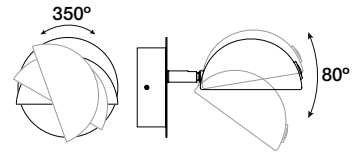
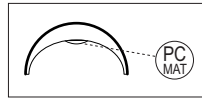
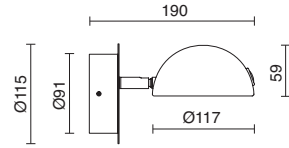

Spot



616A-L0103A-40 ■

LED 3W 240lm 3000K

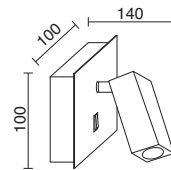



Baltic



727A-Y05X1B-01 □

E27 [Led / Fluo / Hal] max. 60W

+ LED 3W 240lm 3000K

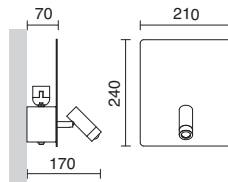

new 727C-Y05X1B-01 □

E27 [Led / Fluo / Hal] max. 60W

+ LED 3W 240lm 3000K



727B-G05X1A-01 □

E27 [Led / Fluo / Hal] max. 60W

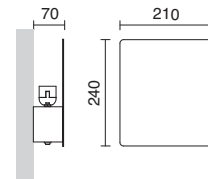



Lesing



509A-L0103B-39 ■

LED 3W 240lm 3000K



509B-L0103B-39 ■

LED 3W 240lm 3000K

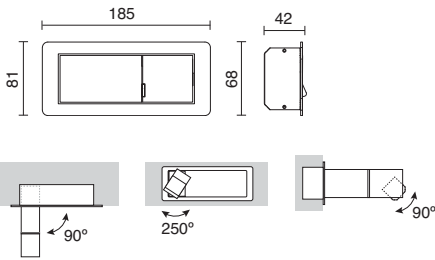
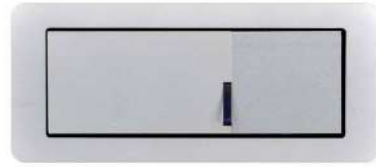

Caja de empotrar / Recessing box
Boîte d'encastrement / Caixa de encastrar

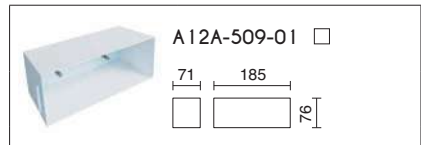

Elfi

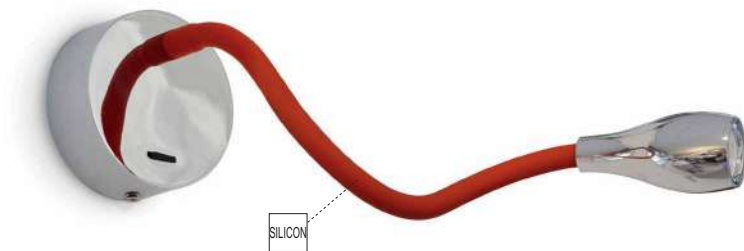

7 10A-LO103A-02 ■

7 10A-LO103A-07 ■

LED 2W 160lm 3000K

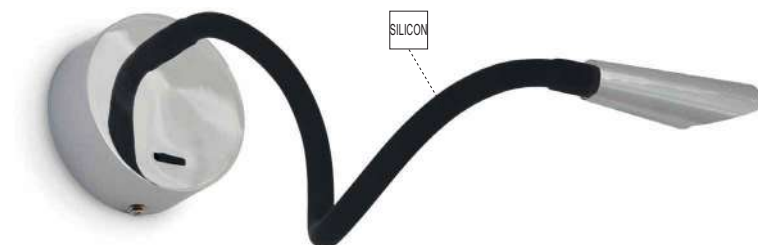
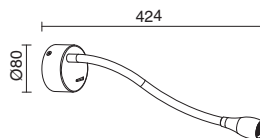

7 10B-LO103A-02 ■

7 10B-LO103A-07 ■

LED 2W 160lm 3000K

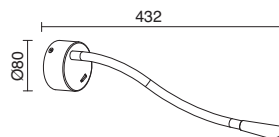

Leiden

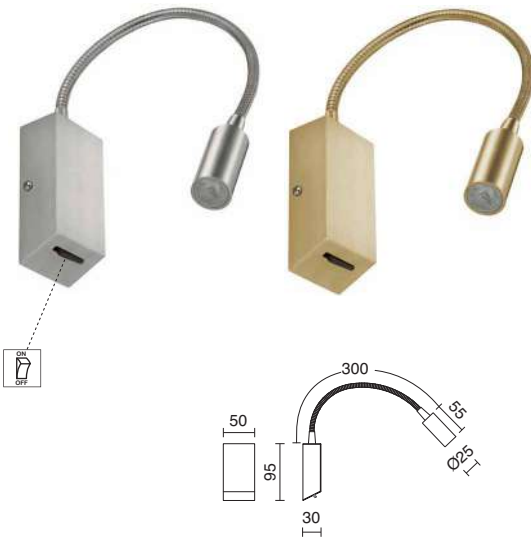

517B-L0103B-35

new 517B-L0103B-46

LED 3W 240lm 3000K

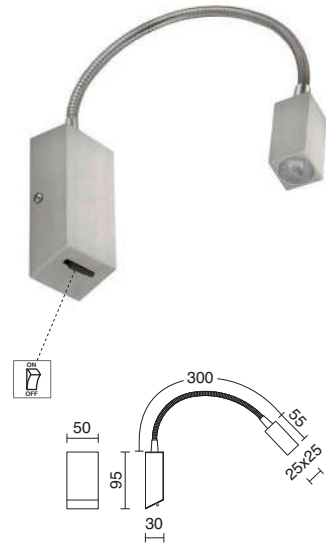

517D-L0103B-35

LED 3W 240lm 3000K

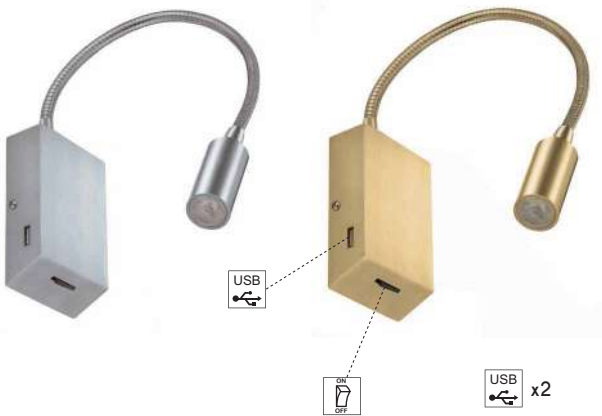

new 517E-L0103B-35

new 517E-L0103B-46

LED 3W 240lm 3000K

Olvas

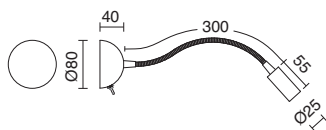
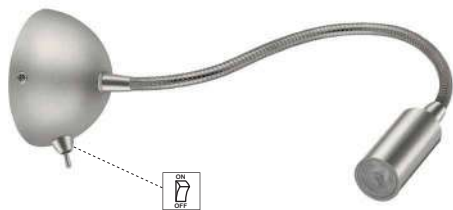

518B-L0103A-35 ■

LED 3W 240lm 3000K

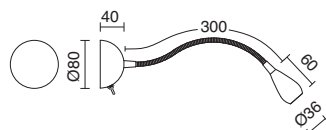
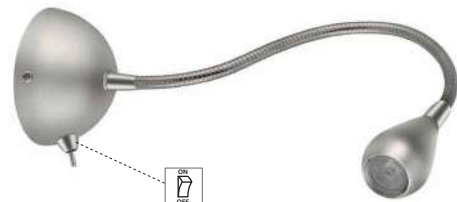

518A-L0103A-35 ■

LED 3W 240lm 3000K



Julia



603A-L0105A-32 □

LED 5W 420lm 3000K

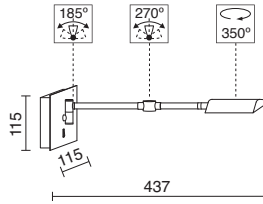
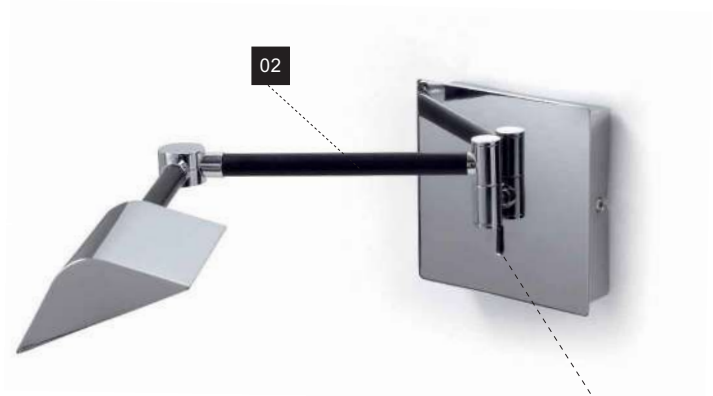

Book



588A-L0104A-02 ■

LED 4W 280lm 3000K

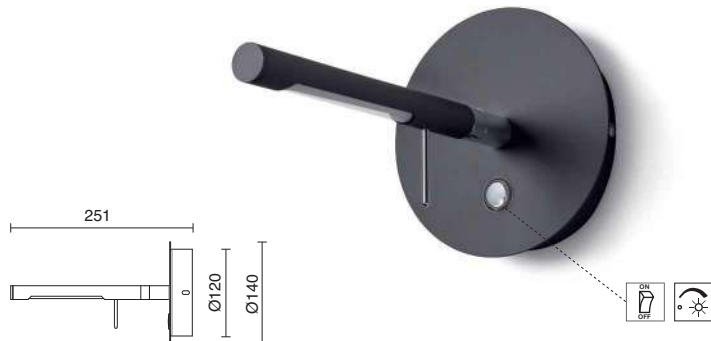



Lore



624A-L0103A-35 ■

LED 3W 240lm 3000K

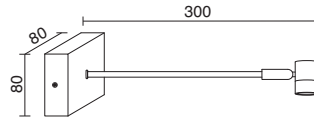

Tabel



625A-L0106A-35 ■

LED 6W 500lm 3000K

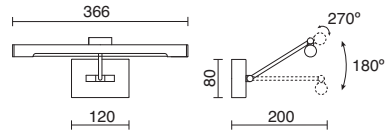

625B-L0112A-35 ■

LED 12W 1000lm 3000K

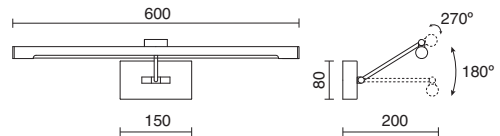



Cloé



680A-G04X1A-13 ■

E14 [Led / Fluo / Hal] max. 40W

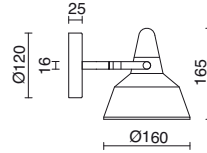

Lámparas recomendadas
Recommended lamps
Lampes recommandées
Lâmpadas recomendadas

LED FILAMENT



pag. 260

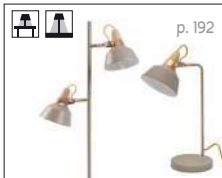

new

Valan



846B-G05X1A-01 □

E27 [Led / Fluo / Hal] max. 60W

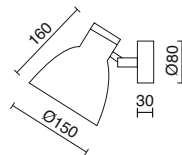

Lámparas recomendadas
Recommended lamps
Lampes recommandées
Lâmpadas recomendadas

LED FILAMENT



pag. 260



Elke



714A-G21X1A-32 □

GU10 [Led / Hal] max. 50W

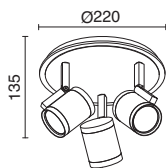
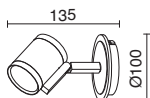

714B-G21X1A-32 □

3x GU10 [Led / Hal] max. 50W

Lámparas recomendadas
Recommended lamps
Lampes recommandées
Lâmpadas recomendadas

LED PRO



pag. 261

▲ Bajo pedido, acabado negro-oro mate.
On request, black- matt gold finish.
À demande, finition noir-or mat.
Sub pedido acabamento preto-matt ouro.



Kasha



723B-G04X1A-CM ■

3x E14 [Led / Fluo / Hal] max. 40W

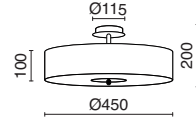

Lámparas recomendadas
 Recommended lamps
 Lampes recommandées
 Lâmpadas recomendadas

LED FILAMENT



pag. 260



Britta



Pantalla no incluida / Shade not included / Abat-Jour exclu / Abajur não incluído



68 1A-G05X1A-02 + A35C-004-CA

68 1A-G05X1A-02 ■

E27 [Led / Fluo / Hal] max. 60W

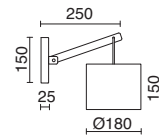

Pantalla disponible / Available shade
Abat-Jour disponible / Abajur disponível

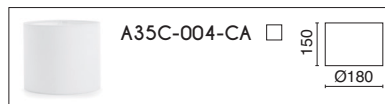

- ▲ Otros acabados de pantalla bajo pedido, pag 273
- Other shade finishes available upon request, pag 273
- Autres finitions des abat-jours sur demande, pag 273
- Outros acabamentos para os Abajures sob pedido, pag 273



Lámparas recomendadas / Recommended lamps
Lampes recommandées / Lâmpadas recomendadas

LED FILAMENT



pag. 260

Easy



Pantalla no incluida / Shade not included / Abat-Jour exclu / Abajur não incluido



595A-C05X 1A-35 + A32A-004-CC

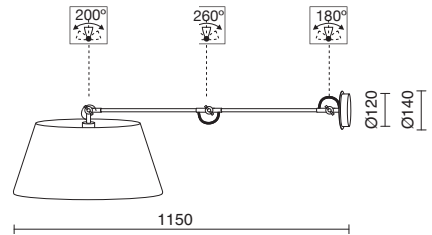

595A-C05X 1A-35

E27 [Led / Fluo / Hal] max. 60W

Pantallas disponibles / Available shades / Abat-Jours disponibles / Abajures disponiveis



▲ Otros acabados de pantalla bajo pedido, pag 273 / Other shade finishes available upon request, pag 273
Autres finitions des abat-jours sur demande, pag 273 / Outros acabamentos para os Abajures sob pedido, pag 273

Lámparas recomendadas / Recommended lamps
Lampes recommandées / Lâmpadas recomendadas

LED FILAMENT



pag. 260





Pantalla no incluida / Shade not included / Abat-Jour exclu / Abajur não incluído



717G-G05X1A-02 + A32C-004-HC (x3)

717G-G05X1A-02 ■

717G-G05X1A-03 ■

3x E27 [Led / Fluo / Hal] max. 60W

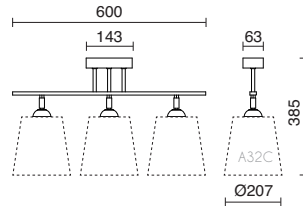
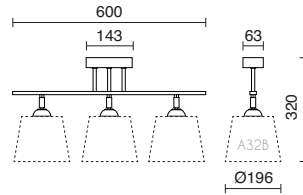

Lámparas recomendadas
Recommended lamps
Lampes recommandées
Lâmpadas recomendadas

LED FILAMENT



pag. 260

Pantallas disponibles / Available shades / Abat-Jours disponibles / Abajures disponíveis

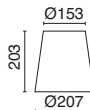
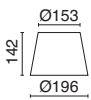

A32B-004-CA

A32C-004-CA

A32B-004-CC

A32C-004-CC

A32B-004-CK

A32C-004-CK

A32B-004-CJ

A32C-004-CJ

A32B-004-CE

A32C-004-CE

A32B-004-HC

A32C-004-HC



▲ Otros acabados de pantalla bajo pedido, pag 273 / Other shade finishes available upon request, pag 273
Autres finitions des abat-jours sur demande, pag 273 / Outros acabamentos para os Abajures sob pedido, pag 273



717G-C05X1A-03 + A32C-004-CJ (x3)



717G-C05X1A-02 + A32C-004-CA (x3)



717G-C05X1A-02 + A32C-004-HC + A32C-004-CJ + A32C-004-CA



717G-C05X1A-02 + A32B-004-HC + A32B-004-CJ + A32B-004-CK



717G-C05X1A-02 + A32B-004-CJ + A32B-004-CE + A32B-004-CJ



717G-C05X1A-03 + A32B-004-CK (x3)



Pantalla no incluida / Shade not included / Abat-Jour exclu / Abajur não incluido



717C-G05X1A-02 ■

717C-G05X1A-32 □

E27 [Led / Fluo / Hal] max. 60W

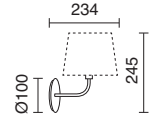

717C-G05X1A-02 + A26E-004-HC



717C-G05X1A-02 + A26E-004-CA



717C-G05X1A-32 + A26E-004-CE



717C-G05X1A-02 + A26E-004-CC



717C-G05X1A-32 + A26E-004-CK

Pantallas disponibles / Available shades
Abat-Jours disponibles / Abajures disponíveis



- A26E-004-CA
- A26E-004-CC
- A26E-004-CK
- A26E-004-CJ
- A26E-004-CE
- A26E-004-HC

Lámparas recomendadas / Recommended lamps
Lampes recommandées / Lâmpadas recomendadas

LED FILAMENT



pag. 260



▲ Otros acabados de pantalla bajo pedido, pag 273 / Other shade finishes available upon request, pag 273
Autres finitions des abat-jours sur demande, pag 273 / Outros acabamentos para os Abajures sob pedido, pag 273

Nuno



Pantalla no incluida / Shade not included / Abat-Jour exclu / Abajur não incluido



841A-Y05X1A-35 ●

E27 [Led / Fluo / Hal] max 60W
+
LED 3W 240lm 3000K

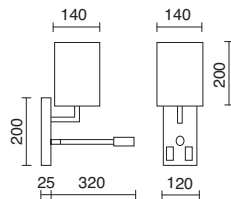

Pantallas disponibles / Available shades / Abat-Jours disponibles / Abajures disponíveis



▲ Otros acabados de pantalla bajo pedido, pag 273 / Other shade finishes available upon request, pag 273
Autres finitions des abat-jours sur demande, pag 273 / Outros acabamentos para os Abajures sob pedido, pag 273



Bay



Pantalla no incluida / Shade not included / Abat-Jour exclu / Abajur não incluído



708A-Y05X1A-32 + A28E-004-CA

708A-Y05X1A-32

E27 [Led / Fluo / Hal] max. 60W
+
LED 2W 160lm 3000K

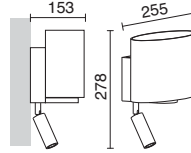

Pantalla disponible / Available shade / Abat-Jour disponible / Abajur disponível



▲ Otros acabados de pantalla bajo pedido, pag 273 / Other shade finishes available upon request, pag 273
Autres finitions des abat-jours sur demande, pag 273 / Outros acabamentos para os Abajures sob pedido, pag 273

Lâmparas recomendadas
Recommended lamps
Lampes recommandées
Lâmpadas recomendadas

LED FILAMENT



pag. 260

Monnet



Pantalla no incluida / Shade not included / Abat-Jour exclu / Abajur não incluído

709A-Y05X1A-35

E27 [Led / Fluo / Hal] max. 60W
+ LED 2W 160lm 3000K



709A-Y05X1A-35 + A36E-004-CC

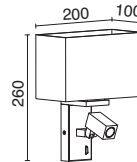

709A-Y05X1A-35 + A36E-004-CA

Pantalla disponible / Available shade / Abat-Jour disponible / Abajur disponível



▲ Otros acabados de pantalla bajo pedido, pag 273 / Other shade finishes available upon request, pag 273
Autres finitions des abat-jours sur demande, pag 273 / Outros acabamentos para os Abajures sob pedido, pag 273

Lámparas recomendadas
Recommended lamps
Lampes recommandées
Lâmpadas recomendadas

LED FILAMENT



pag. 260

Firenze



Pantalla no incluida / Shade not included / Abat-Jour exclu / Abajur não incluido

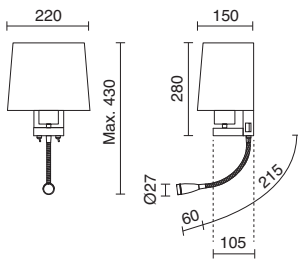

new 507F-Y05X 1B-35

new 507F-Y05X 1B-46

E27 [Led / Fluo / Hal] max. 60W
+ LED 3W 240lm 3000K

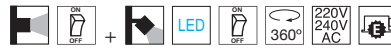

507A-Y05X 1B-35

new 507A-Y05X 1B-46

E27 [Led / Fluo / Hal] max. 60W
+ LED 3W 240lm 3000K



507E-Y05X 1B-35

E27 [Led / Fluo / Hal] max. 60W
+ LED 3W 240lm 3000K



Pantallas disponibles / Available shades / Abat-Jours disponibles / Abajures disponíveis

	A26A-004-CA <input type="checkbox"/>		A26A-004-CC <input type="checkbox"/>		new A26A-004-CB <input checked="" type="checkbox"/>	
	A27A-004-CA <input type="checkbox"/>		A27A-004-CC <input type="checkbox"/>		new A27A-004-CB <input checked="" type="checkbox"/>	

▲ Otros acabados de pantalla bajo pedido, pag 273 / Other shade finishes available upon request, pag 273
Autres finitions des abat-jours sur demande, pag 273 / Outros acabamentos para os Abajures sob pedido, pag 273



Lámparas recomendadas / Recommended lamps
Lampes recommandées / Lâmpadas recomendadas

LED FILAMENT



pag. 260



Firenze



507B-G05X1A-35 + A27A-004-CC

507B-G05X1A-35

E27 [Led / Fluo / Hal] max. 60W

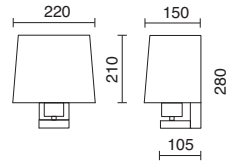

Pantallas disponibles / Available shades / Abat-Jours disponibles / Abajures disponibles

	A26A-004-CA <input type="checkbox"/>		A26A-004-CC <input type="checkbox"/>		new A26A-004-CB <input type="checkbox"/>	
	A27A-004-CA <input type="checkbox"/>		A27A-004-CC <input type="checkbox"/>		new A27A-004-CB <input type="checkbox"/>	

▲ Otros acabados de pantalla bajo pedido, pag 273 / Other shade finishes available upon request, pag 273
Autres finitions des abat-jours sur demande, pag 273 / Outros acabamentos para os Abajures sob pedido, pag 273



Lámparas recomendadas / Recommended lamps
Lampes recommandées / Lâmpadas recomendadas

LED FILAMENT



pag. 260



Oval



Pantalla no incluida / Shade not included / Abat-Jour exclu / Abajur não incluido



611C-G05X1A-35

E27 [Led / Fluo / Hal] max. 60W

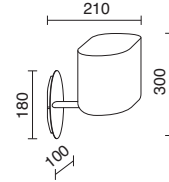

611C-G05X1A-35 + A28A-004-CC



611B-G05X1A-35

E27 [Led / Fluo / Hal] max. 60W

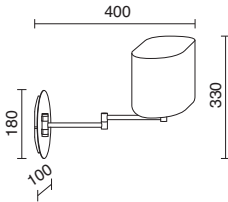

611B-G05X1A-35 + A28A-004-CA



611A-Y05X1A-35

E27 [Led / Fluo / Hal] max. 60W

+ LED 3W 240lm 3000K

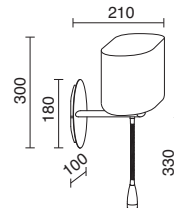

611A-G05X1A-35 + A28A-004-CC

Pantallas disponibles / Available shades
Abat-Jours disponibles / Abajures disponíveis

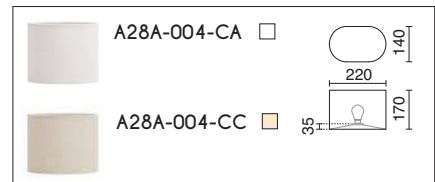

▲ Otros acabados de pantalla bajo pedido, pag 273
Other shade finishes available upon request, pag 273
Autres finitions des abat-jours sur demande, pag 273
Outros acabamentos para os Abajures sob pedido, pag 273



Lámparas recomendadas / Recommended lamps
Lampes recommandées / Lâmpadas recomendadas

LED FILAMENT



pag. 260



Gina



Pantalla no incluida / Shade not included / Abat-Jour exclu / Abajur não incluido



600C-G05X1A-35 ■

E27 [Led / Fluo / Hal] max. 60W

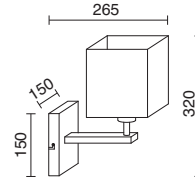

600C-G05X1A-35 + A30A-004-CC

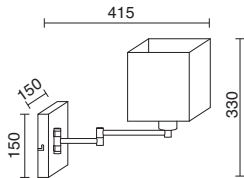

600B-G05X1A-35 ■

E27 [Led / Fluo / Hal] max. 60W



600B-G05X1A-35 + A30A-004-CA



600A-Y05X1A-35 ■

E27 [Led / Fluo / Hal] max. 60W

+ LED 3W 240lm 3000K

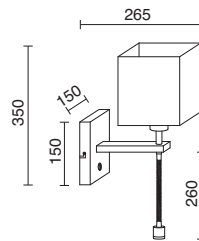

600A-G05X1A-35 + A30A-004-CC

Lámparas recomendadas
Recommended lamps
Lampes recommandées
Lâmpadas recomendadas

LED FILAMENT



pag. 260



Pantallas disponibles / Available shades / Abat-Jours disponibles / Abajures disponíveis



▲ Otros acabados de pantalla bajo pedido, pag 273 / Other shade finishes available upon request, pag 273
Autres finitions des abat-jours sur demande, pag 273 / Outros acabamentos para os Abajures sob pedido, pag 273



Gina



Pantalla no incluida / Shade not included / Abat-Jour exclu / Abajur não incluido

600G-G05X1A-35

2x E27 [Led / Fluo / Hal] max. 60W

Lámparas recomendadas
Recommended lamps
Lampes recommandées
Lâmpadas recomendadas

LED FILAMENT



pag. 260

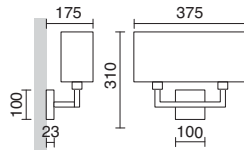

600G-G05X1A-35 + A36D-004-CA

Pantallas disponibles / Available shades / Abat-Jours disponibles / Abajures disponíveis



▲ Otros acabados de pantalla bajo pedido, pag 273 / Other shade finishes available upon request, pag 273
Autres finitions des abat-jours sur demande, pag 273 / Outros acabamentos para os Abajures sob pedido, pag 273



Verona



Pantalla no incluida / Shade not included / Abat-Jour exclu / Abajur não incluido



510A-Y04X1B-35

E14 [Led / Fluo / Hal] max. 40W
+
LED 3W 240lm 3000K

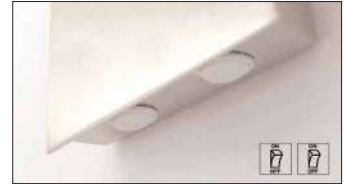

510A-Y04X1B-35 + A29A-004-CA

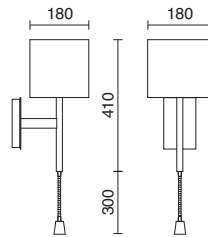

510A-Y04X1B-35 + A30A-004-CA

Pantallas disponibles / Available shades
Abat-Jours disponibles / Abajures disponíveis

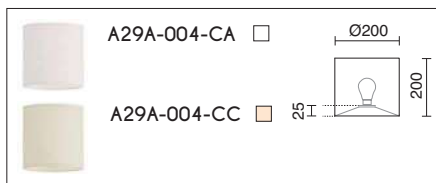

Pantallas disponibles / Available shades
Abat-Jours disponibles / Abajures disponíveis

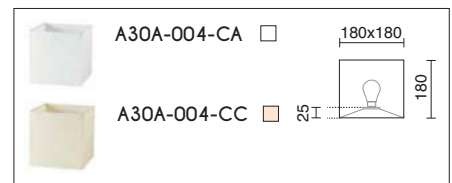

Lámparas recomendadas
Recommended lamps
Lampes recommandées
Lâmpadas recomendadas

LED FILAMENT



pag. 260

▲ Otros acabados de pantalla bajo pedido, pag 273 / Other shade finishes available upon request, pag 273
Autres finitions des abat-jours sur demande, pag 273 / Outros acabamentos para os Abajures sob pedido, pag 273

Bearn



Pantalla no incluida / Shade not included / Abat-Jour exclu / Abajur não incluido



516A-Y04X1B-32 + A26A-516-CA



516A-Y04X1B-32 □

E14 [Led / Fluo / Hal] max. 40W
+ LED 3W 240lm 3000K

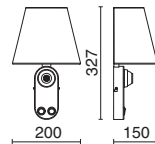

Pantallas disponibles / Available shades
Abat-Jours disponibles / Abajures disponíveis

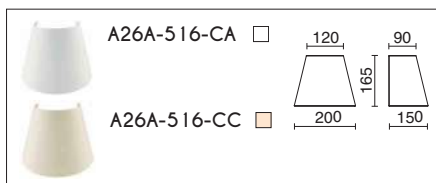

▲ Otros acabados de pantalla bajo pedido, pag 273
Other shade finishes available upon request, pag 273
Autres finitions des abat-jours sur demande, pag 273
Outros acabamentos para os Abajures sob pedido, pag 273

LED FILAMENT



pag. 260

Lámparas recomendadas / Recommended lamps
Lampes recommandées / Lâmpadas recomendadas

Eda



Pantalla no incluida / Shade not included / Abat-Jour exclu / Abajur não incluido



596A-Y05X1A-32 + A26D-004-CA



596A-Y05X1A-32 □

E27 [Led / Fluo / Hal] max. 60W
+ LED 3W 240lm 3000K

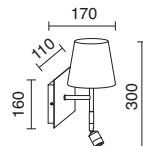

Pantallas disponibles / Available shades
Abat-Jours disponibles / Abajures disponíveis

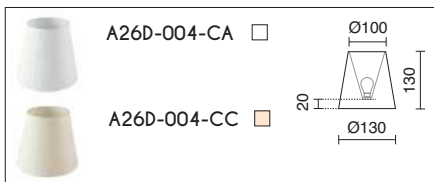

▲ Otros acabados de pantalla bajo pedido, pag 273
Other shade finishes available upon request, pag 273
Autres finitions des abat-jours sur demande, pag 273
Outros acabamentos para os Abajures sob pedido, pag 273

Lámparas recomendadas / Recommended lamps
Lampes recommandées / Lâmpadas recomendadas

LED FILAMENT



pag. 260



Colgantes

Pendant
Suspensions
Suspensão



new

Tess

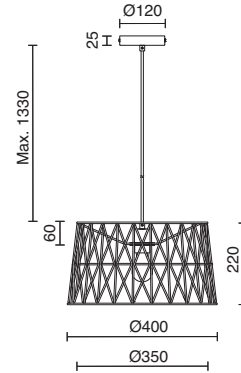

837C-G05X1A-01 □

E27 [Led / Fluo / Hal] max. 60W

Lámparas recomendadas / Recommended lamps
Lampes recommandées / Lâmpadas recomendadas

LED FILAMENT



pag. 260

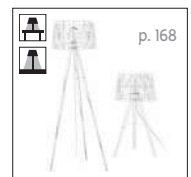



new

Selma

840B-G05X 1A-55 840B-G05X 1A-56

E27 [Led / Fluo / Hal] max. 40W

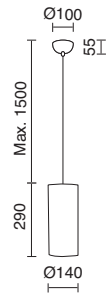

Lámparas recomendadas / Recommended lamps
Lampes recommandées / Lâmpadas recomendadas

LED FILAMENT



pag. 260



new

Selma

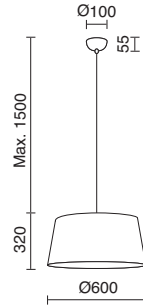

840A-G05X1A-55

840A-G05X1A-56

E27 [Led / Fluó / Hal] max. 40W



Lámparas recomendadas / Recommended lamps
Lampes recommandées / Lâmpadas recomendadas

LED FILAMENT



pag. 260



new

Fiyi



838A-G05X1A-54 ■

E27 [Led / Fluó / Hal] max. 60W

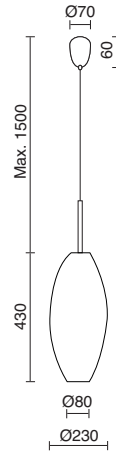

Lámparas recomendadas / Recommended lamps
Lampes recommandées / Lâmpadas recomendadas

LED FILAMENT



pag. 260



Vimet



724A-G05X1A-53 ■

new 724A-G05X1A-54 ■

E27 [Led / Fluo / Hal] max. 60W

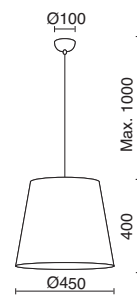

Lámparas recomendadas / Recommended lamps
Lampes recommandées / Lâmpadas recomendadas

LED FILAMENT



pag. 260



Cuska



720A-G05X1A-50 ■

E27 [Led / Fluo / Hal] max. 60W

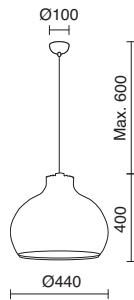
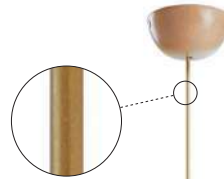

new 720B-G05X1A-50 ■

E27 [Led / Fluo / Hal] max. 60W

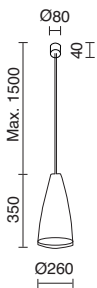

Lámparas recomendadas / Recommended lamps / Lampes recommandées / Lâmpadas recomendadas

LED FILAMENT



pag. 260



Beton

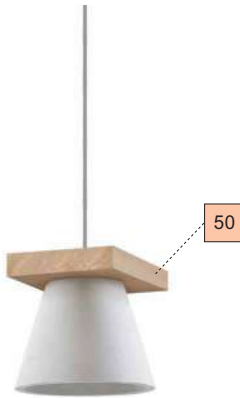

683A-G04X1A-03 ■

E14 [Led / Fluo / Hal] max. 40W

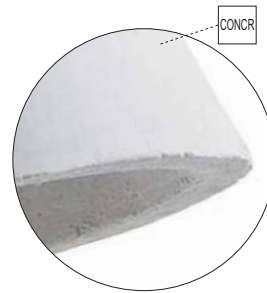
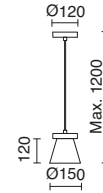

683B-G04X1A-03 ■

3x E14 [Led / Fluo / Hal] max. 40W

Lámparas recomendadas
Recommended lamps
Lampes recommandées
Lâmpadas recomendadas

LED FILAMENT



pag. 260

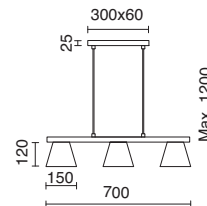



Baguet



685B-G05X1A-02 ■

E27 [Led / Fluo / Hal] max. 60W

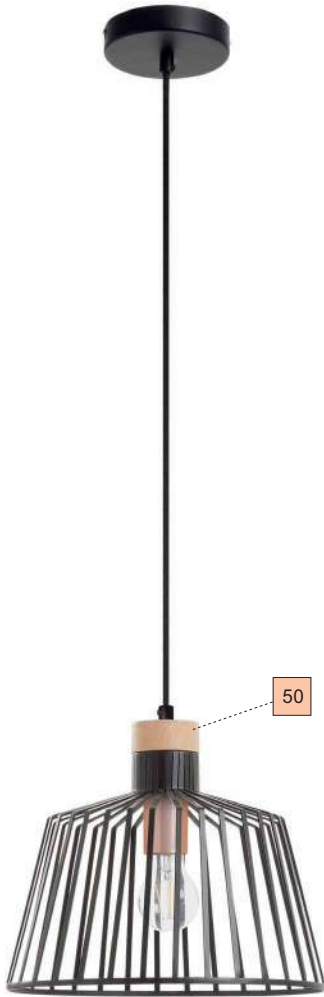

685A-G05X1A-02 ■

E27 [Led / Fluo / Hal] max. 60W

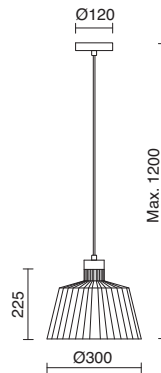

Lámparas recomendadas / Recommended lamps / Lampes recommandées / Lâmpadas recomendadas

LED FILAMENT



pag. 260



Elga



684A-G05X1A-02 ■

E27 [Led / Fluo / Hal] max. 60W

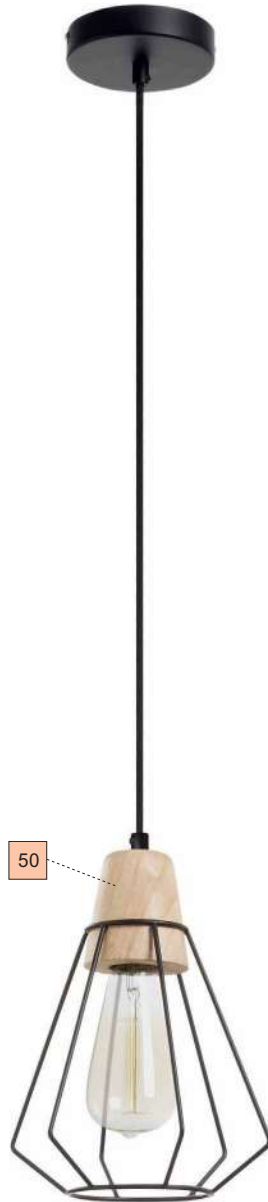
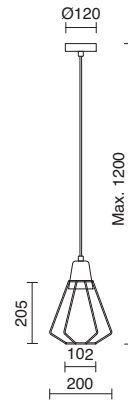

Lámparas recomendadas / Recommended lamps / Lampes recommandées / Lâmpadas recomendadas

LED FILAMENT



pag. 260



Flavia

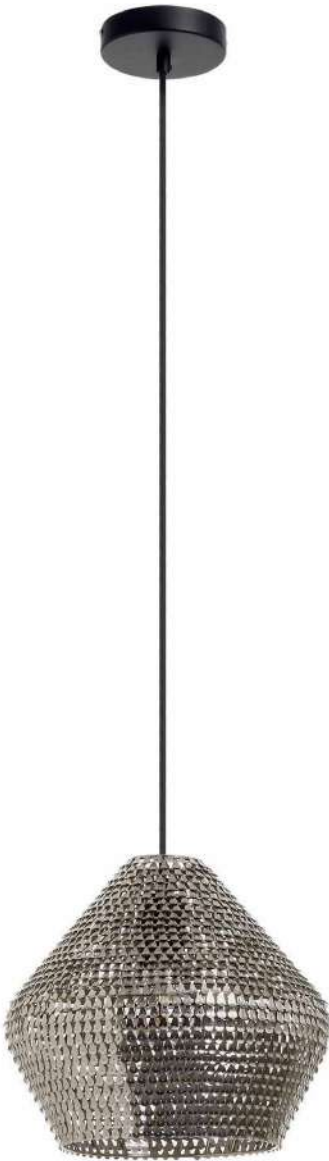

686A-G05X1A-44 □

E27 [Led / Fluo / Hal] max. 60W

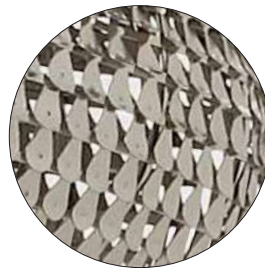
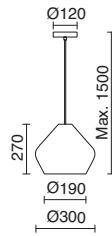

Lámparas recomendadas / Recommended lamps
Lampes recommandées / Lâmpadas recomendadas

LED FILAMENT



pag. 260



Sira



687A-G05X1A-01

687A-G05X1A-37

E27 [Led / Fluo / Hal] max. 60W

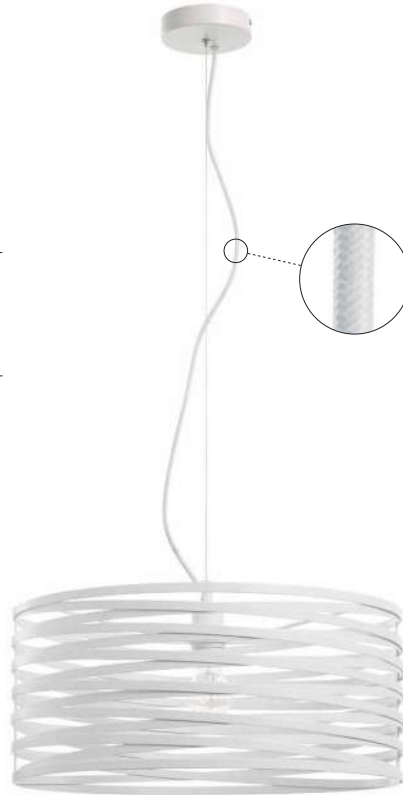
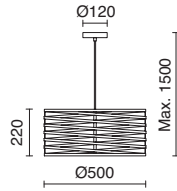

Lámparas recomendadas / Recommended lamps
Lampes recommandées / Lâmpadas recomendadas

LED FILAMENT



pag. 260



Dora



594A-G05X1A-01 □

E27 [Led / Fluo / Hal] max. 60W

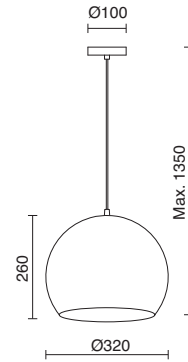

Lámparas recomendadas / Recommended lamps
Lampes recommandées / Lâmpadas recomendadas

LED FILAMENT



pag. 260

Eyra Glass

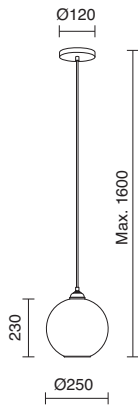

597A-G05X1A-01 □

E27 [Led / Fluo / Hal] max. 60W

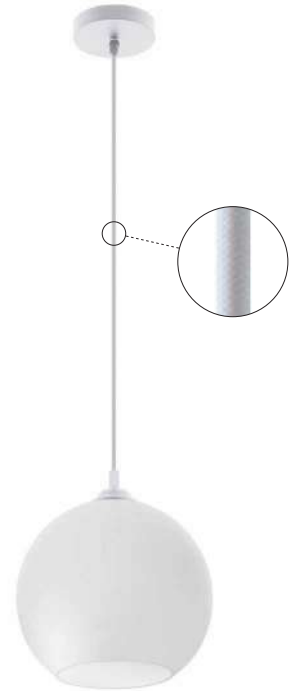

Lámparas recomendadas / Recommended lamps
Lampes recommandées / Lâmpadas recomendadas

LED FILAMENT



pag. 260

Estikla



- 719A-G04X1A-01
- 719A-G04X1A-02
- 719A-G04X1A-07

E14 [Led / Fluo / Hal] max. 40W

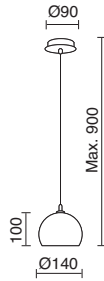
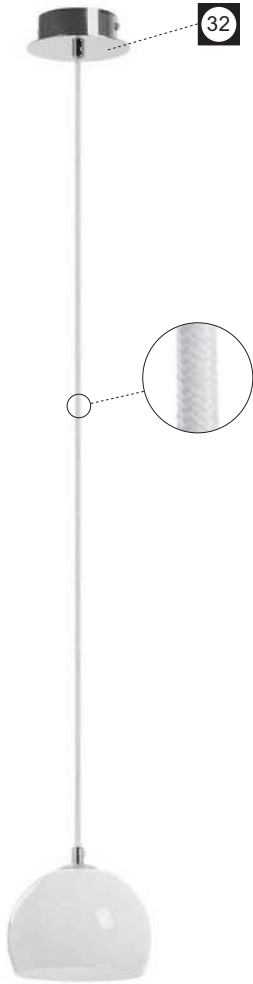

- 719B-G04X1A-01
- 719B-G04X1A-02
- 719B-G04X1A-07

E14 [Led / Fluo / Hal] 3x max. 40W

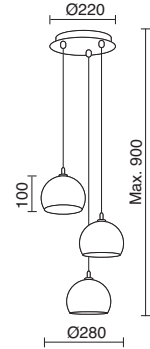

- 719C-G04X1A-01
- 719C-G04X1A-02
- 719C-G04X1A-07

E14 [Led / Fluo / Hal] 5x max. 40W

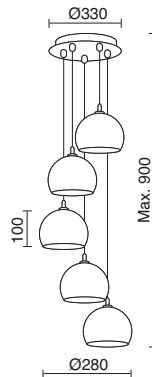

Lámparas recomendadas
Recommended lamps
Lampes recommandées
Lâmpadas recomendadas

LED FILAMENT



pag. 260



Brenda



725A-G05X1A-29 □

E27 [Led / Fluo / Hal] max. 60W

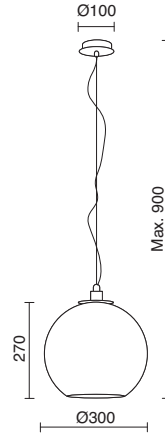

Lámparas recomendadas / Recommended lamps
Lampes recommandées / Lâmpadas recomendadas

LED FILAMENT



pag. 260

Cupertino



699A-LO105b-37 ■

LED 4,8W 240lm 3000K



Gilda



698A-L0105B-37 ■

LED 4,8W 240lm 3000K

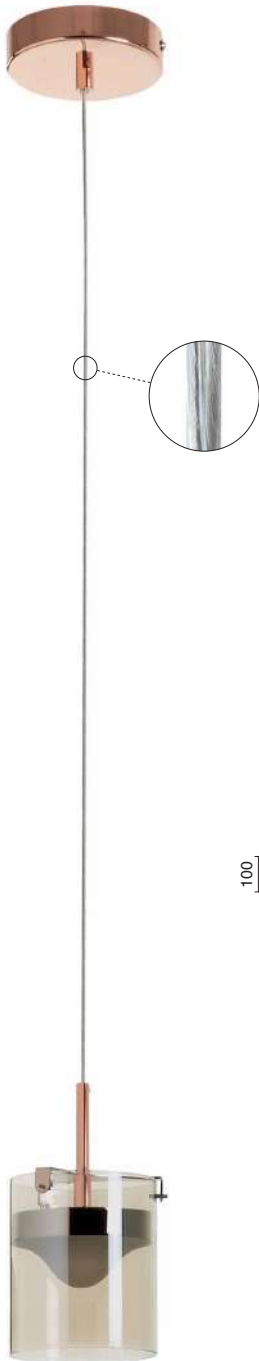

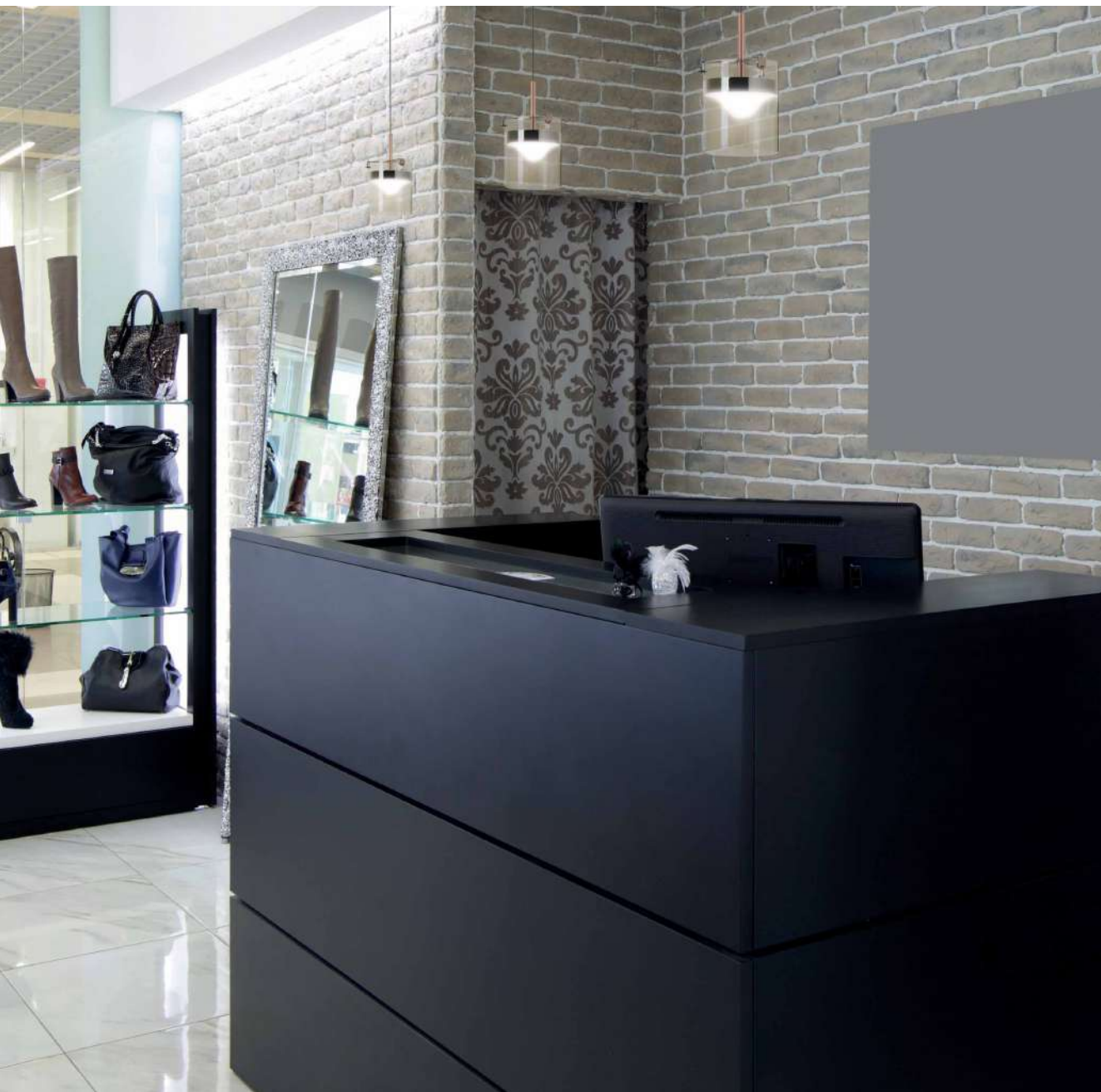

Alessandra

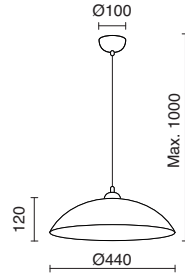

721A-G05X1A-94 ■

E27 [Led / Fluo / Hal] max. 60W



721A-G05X1A-95 ■

E27 [Led / Fluo / Hal] max. 60W

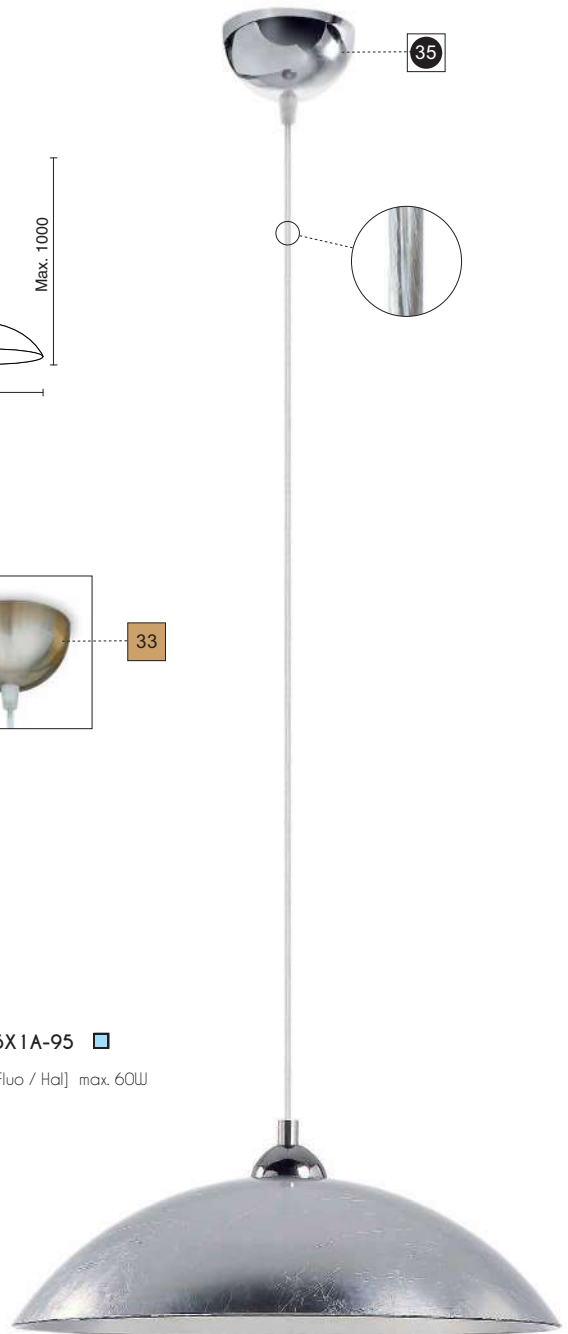

Lámparas recomendadas / Recommended lamps
Lampes recommandées / Lâmpadas recomendadas

LED FILAMENT



pag. 260

Alessandra



72 1B-G05X1A-92 □

E27 [Led / Fluo / Hal] max. 60W

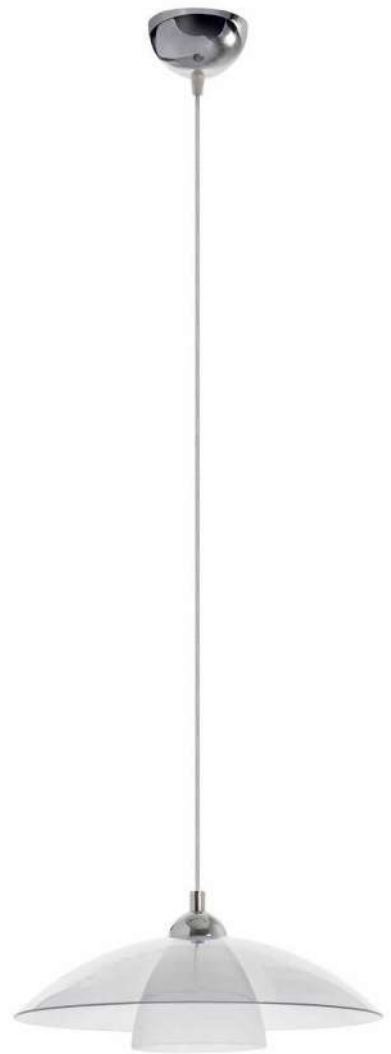
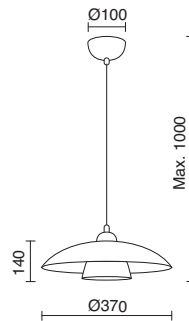

Lámparas recomendadas / Recommended lamps
Lampes recommandées / Lâmpadas recomendadas

LED FILAMENT



pag. 260

Aliya



584B-LO1H4A-01 □
LED 4x 10W 4x 900lm 3000K

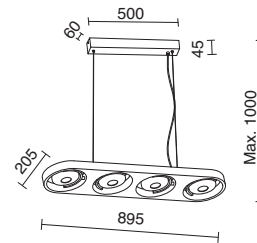

p. 48



Fred



- A20A-715-01
- A20A-715-02
- A20A-715-03

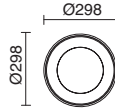
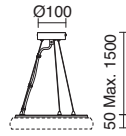

- 715A-L0125A-01
- 715A-L0125A-02
- 715A-L0125A-03

LED 25W 1850lm 3000K

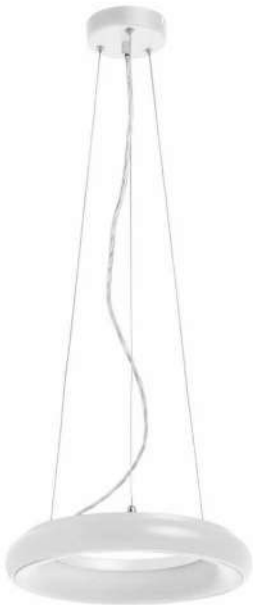

715A-L0125A-01 + A20A-715-01

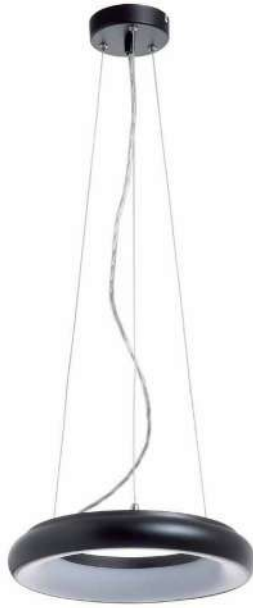

715A-L0125A-02 + A20A-715-02

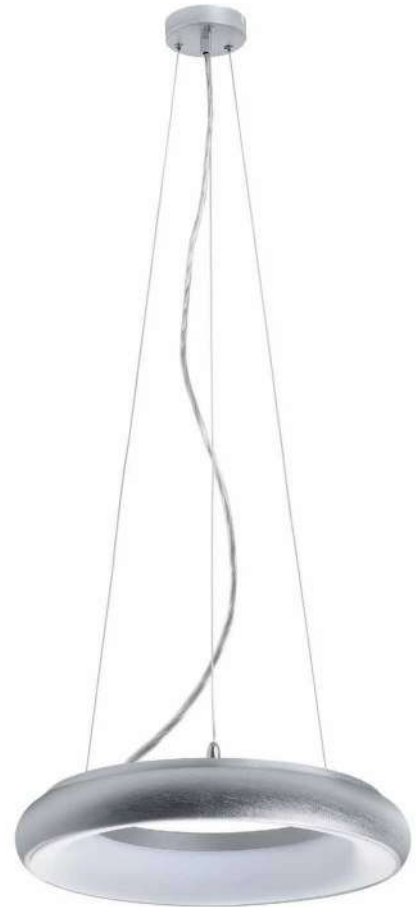

715B-L3135A-03 + A20A-715-03

- 715B-L3135A-01
- 715B-L3135A-02
- 715B-L3135A-03

LED 35W 2940lm 3000K

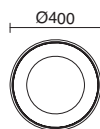
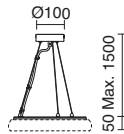

Kasha

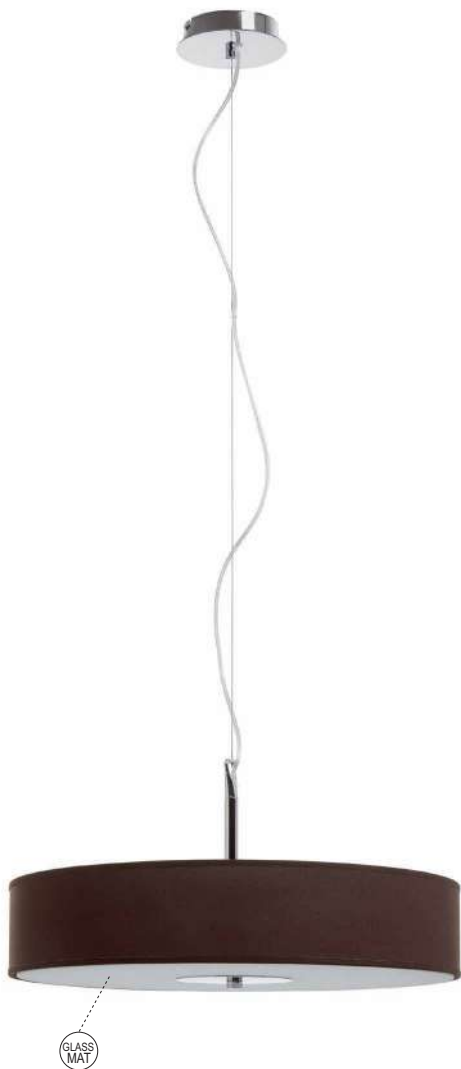

723A-G04X1A-CM ■

3x E14 [Led / Fluo / Hal] 3x max. 40W

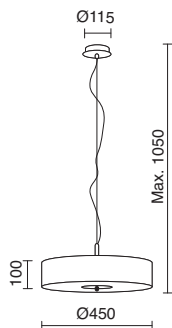

Lámparas recomendadas
Recommended lamps
Lampes recommandées
Lâmpadas recomendadas

LED FILAMENT

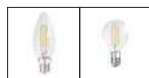

pag. 260





Pantalla no incluida / Shade not included / Abat-Jour exclu / Abajur não incluído

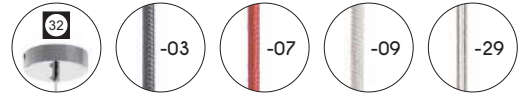

7 16A-G05X 1A-03

7 16A-G05X 1A-07

7 16A-G05X 1A-09

7 16A-G05X 1A-29

E27 [Led / Fluo / Hal] max. 60W



716A-G05X1A-29 + A32D-004-CK



716A-G05X1A-07 + A32C-004-HC

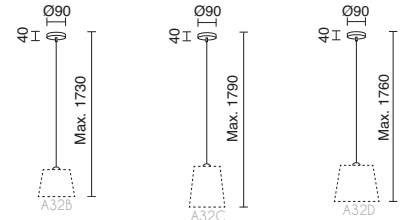

Pantallas disponibles / Available shades / Abat-Jours disponibles / Abajures disponíveis



- A32B-004-CA
- A32B-004-CC
- A32B-004-CK
- A32B-004-CJ
- A32B-004-CE
- A32B-004-HC



- A32C-004-CA
- A32C-004-CC
- A32C-004-CK
- A32C-004-CJ
- A32C-004-CE
- A32C-004-HC

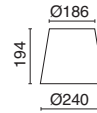

- A32D-004-CA
- A32D-004-CC
- A32D-004-CK
- A32D-004-CJ
- A32D-004-CE
- A32D-004-HC

▲ Otros acabados de pantalla bajo pedido, pag 273 / Other shade finishes available upon request, pag 273
Autres finitions des abat-jours sur demande, pag 273 / Outros acabamentos para os Abajures sob pedido, pag 273

Lámparas recomendadas
Recommended lamps
Lampes recommandées
Lâmpadas recomendadas

LED FILAMENT



pag. 260



p. 80



p. 82



p. 170



716A-C05X1A-09 + A32D-004-CC



716A-C05X1A-07 + A32D-004-CJ



716A-C05X1A-07 + A32B-004-CA



716A-C05X1A-03 + A32C-004-CE



716A-C05X1A-29 + A32C-004-CJ



716A-C05X1A-09 + A32B-004-HC

A TU ESTILO



Pantalla no incluida / Shade not included / Abat-Jour exclu / Abajur não incluído



716B-G05X1A-29
+
A32C-004-CJ
+
A32C-004-CK
+
A32C-004-HC

716B-G05X1A-07
+
A32C-004-CJ
+
A32C-004-CK
+
A32C-004-CA

- 716B-G05X1A-03
- 716B-G05X1A-07
- 716B-G05X1A-09
- 716B-G05X1A-29

3x E27 [Led / Fluvo / Hal] max. 60W

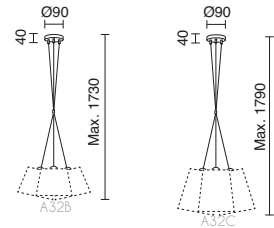

Pantallas disponibles / Available shades / Abat-Jours disponibles / Abajures disponíveis

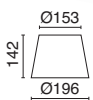

- | | |
|---|---|
| A32B-004-CA <input type="checkbox"/> | A32C-004-CA <input type="checkbox"/> |
| A32B-004-CC <input type="checkbox"/> | A32C-004-CC <input type="checkbox"/> |
| A32B-004-CK <input type="checkbox"/> | A32C-004-CK <input type="checkbox"/> |
| A32B-004-CJ <input checked="" type="checkbox"/> | A32C-004-CJ <input checked="" type="checkbox"/> |
| A32B-004-CE <input type="checkbox"/> | A32C-004-CE <input type="checkbox"/> |
| A32B-004-HC <input type="checkbox"/> | A32C-004-HC <input type="checkbox"/> |

▲ Otros acabados de pantalla bajo pedido, pag 273 / Other shade finishes available upon request, pag 273
Autres finitions des abat-jours sur demande, pag 273 / Outros acabamentos para os Abajures sob pedido, pag 273

Lámparas recomendadas
Recommended lamps
Lampes recommandées
Lâmpadas recomendadas

LED FILAMENT



pag. 260







Lámpara no incluida / Lamp not included / Lampde pas inclus / Lâmpada não incluído



7 17D-G05X 1A-01

7 17D-G05X 1A-02

7 17D-G05X 1A-32

E27 [Led / Vintage] max. 60W

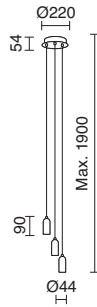

7 17E-G05X 1A-01

7 17E-G05X 1A-02

7 17E-G05X 1A-32

E27 [Led / Vintage] 3x max. 60W

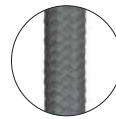

7 17F-G05X 1A-01

7 17F-G05X 1A-02

7 17F-G05X 1A-32

E27 [Led / Vintage] 5x max. 60W

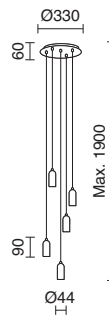

Lámparas recomendadas / Recommended lamps / Lampes recommandées / Lâmpadas recomendadas

LED FILAMENT



pag. 260



Selene



Lámpara no incluida / Lamp not included / Lampde pas inclus / Lâmpada não incluído



728A-G05X1A-02 ■

728A-G05X1A-35 ●

728A-G05X1A-37 ■

E27 [Led / Fluo / Hal] max. 60W

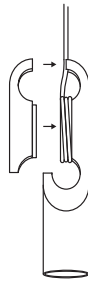
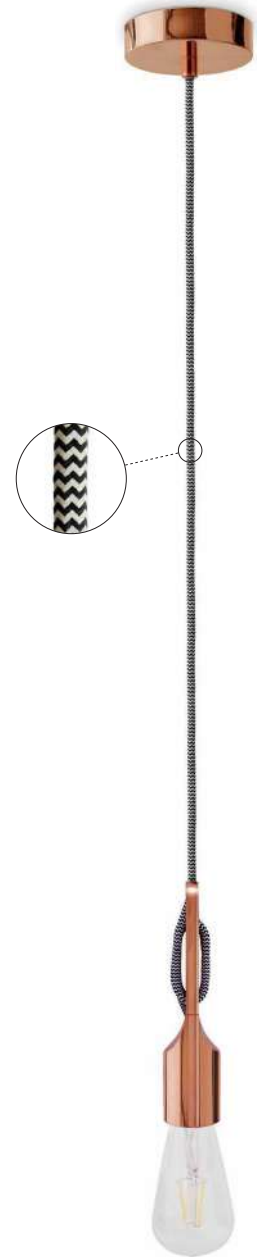
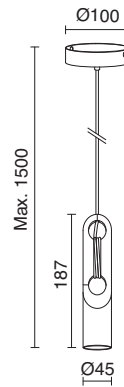

Lamparas recomendadas / Recommended lamps / Lampes recommandées / Lâmpadas recomendadas

LED FILAMENT



pag. 260



Aprilla



Lámpara no incluida / Lamp not included / Lampade pas inclus / Lâmpada não incluído

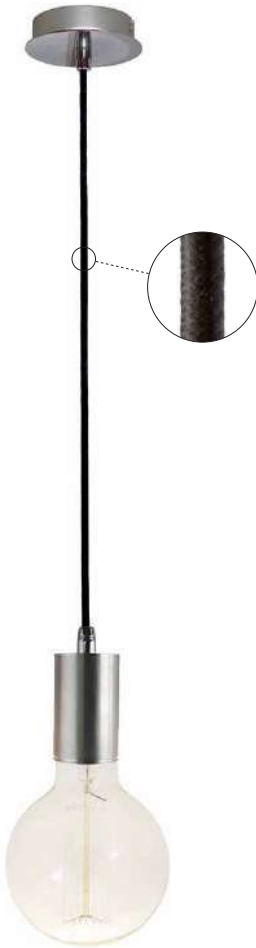

499A-G05X 1A-39 ■

E27 [Led / Fluo / Hal] max. 60W



Lámparas recomendadas / Recommended lamps
Lampes recommandées / Lâmpadas recomendadas

LED FILAMENT



pag. 260



Kaira



605A-C04X1A-10 □

E14 [Led / Fluo / Hal] max. 40W

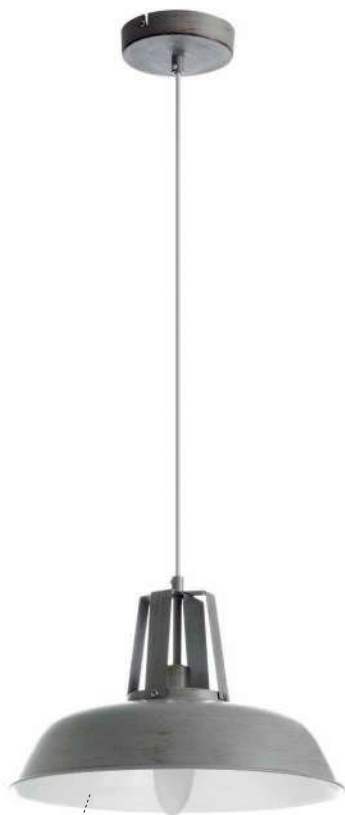

01

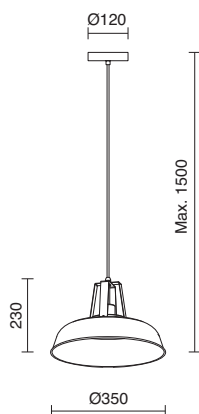

Lámparas recomendadas
Recommended lamps
Lampes recommandées
Lâmpadas recomendadas

LED FILAMENT



pag. 260

Cloé

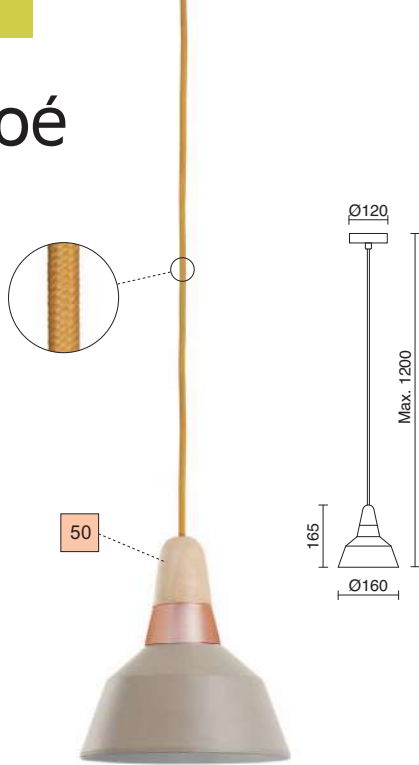

680B-G04X1A-13 ■

E14 [Led / Fluo / Hal] max. 40W

Lámparas recomendadas
Recommended lamps
Lampes recommandées
Lâmpadas recomendadas

LED FILAMENT



pag. 260

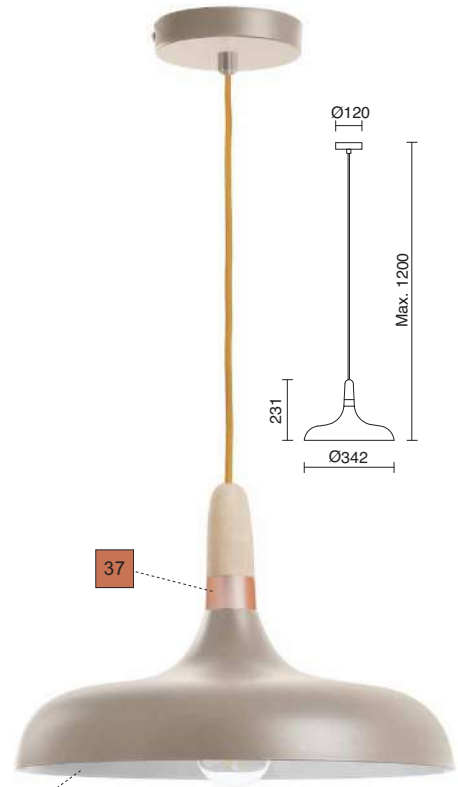

680C-G05X1A-13 ■

E27 [Led / Fluo / Hal] max. 60W

Lámparas recomendadas / Recommended lamps
Lampes recommandées / Lâmpadas recomendadas

LED FILAMENT



pag. 260

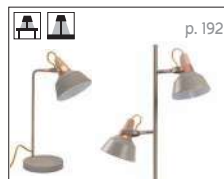



MENU
food and drink

new

Lírica

844A-G05X1A-01 844A-G05X1A-03

E27 [Led / Fluo / Hal] max. 60W

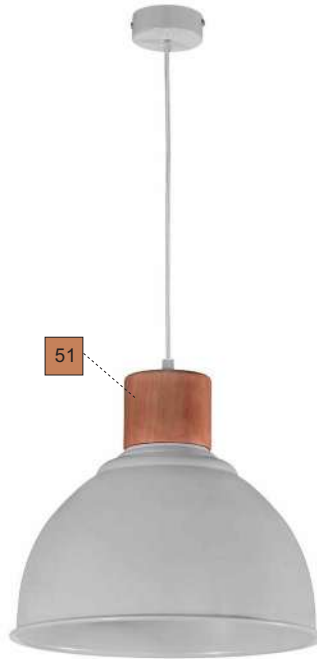
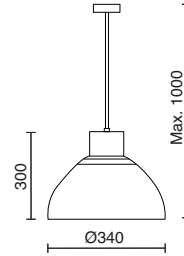

Lámparas recomendadas / Recommended lamps
Lampes recommandées / Lâmpadas recomendadas

LED FILAMENT



pag. 260



new

Valan

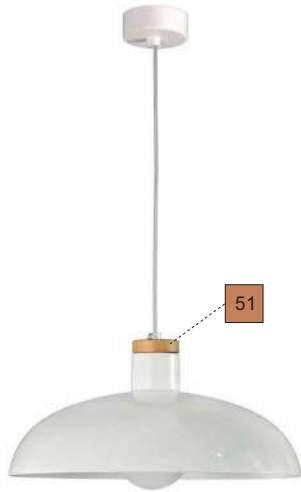

846A-G05X1A-01 □

E27 [Led / Fluo / Hal] max. 60W

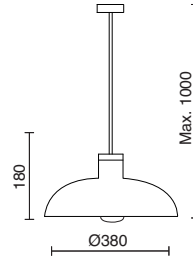

Lámparas recomendadas / Recommended lamps
Lampes recommandées / Lâmpadas recomendadas

LED FILAMENT



pag. 260

new

Lacio



843A-G05X1A-01 □

E27 [Led / Fluo / Hal] max. 60W

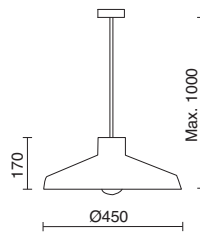

Lámparas recomendadas / Recommended lamps
Lampes recommandées / Lâmpadas recomendadas

LED FILAMENT



pag. 260



Antiq

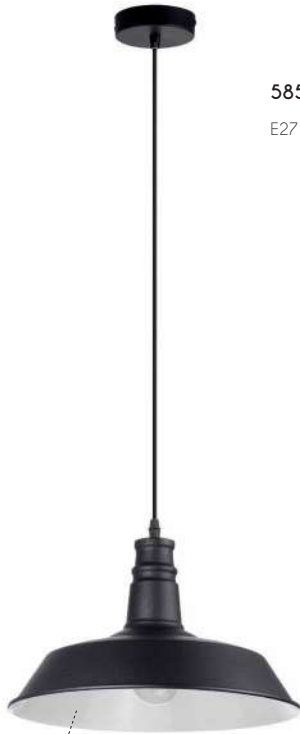

01

585A-G05X 1A-02 ■

E27 [Led / Fluo / Hal] max. 60W

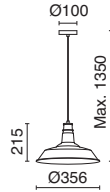

Vintage

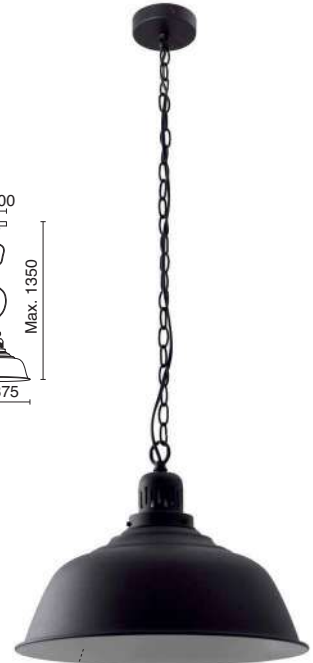

03

620A-G05X 1A-02 ■

E27 [Led / Fluo / Hal] max. 60W



Lámparas recomendadas / Recommended lamps
Lampes recommandées / Lâmpadas recomendadas

LED FILAMENT



pag. 260



Livia



682A-G05X1A-91 ■

E27 [Led / Fluo / Hal] max. 60W

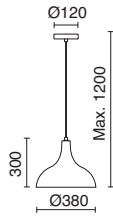

Lámparas recomendadas / Recommended lamps
Lampes recommandées / Lâmpadas recomendadas

LED FILAMENT



pag. 260



Tanna



94

618A-G05X1A-02 ■

E27 [Led / Fluo / Hal] max. 60W

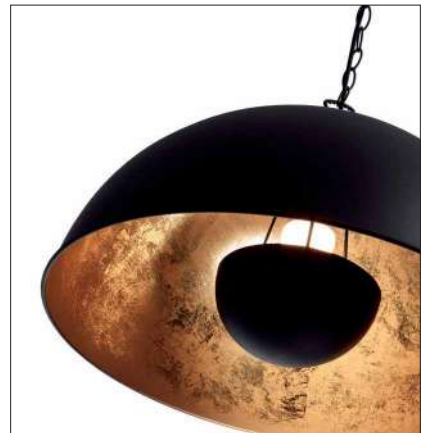
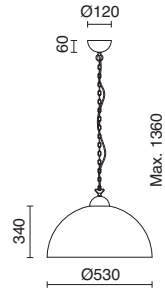

Lámparas recomendadas / Recommended lamps
Lampes recommandées / Lâmpadas recomendadas

LED FILAMENT



pag. 260



Olivia

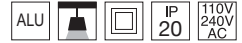

610A-G05X1A-42 ■

E27 [Led / Fluo / Hal] max. 60W

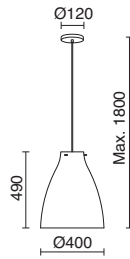

Bell

586A-G05X1A-01 □

E27 [Led / Fluo / Hal] max. 60W

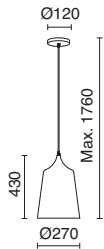

01

01

Lámparas recomendadas / Recommended lamps
Lampes recommandées / Lâmpadas recomendadas

LED FILAMENT



pag. 260



Camila



601A-G05X1A-32

601A-G05X1A-37

E27 [Led / Fluo / Hal] max. 60W

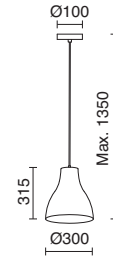

Lámparas recomendadas / Recommended lamps
Lampes recommandées / Lâmpadas recomendadas

LED FILAMENT



pag. 260

Mildred



608A-G05X 1A-40 

E27 [Led / Fluo / Hal] max. 60W

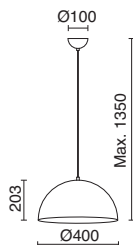

Lámparas recomendadas / Recommended lamps
Lampes recommandées / Lâmpadas recomendadas

LED FILAMENT



pag. 260

Dina



593A-L0108A-01

593A-L0108A-03

LED 8W 500lm 3000K

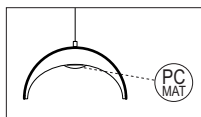
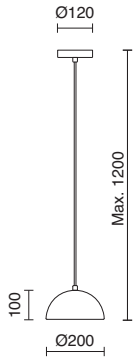



Kable 12



Galada

164D-G23X1D-32 □

GU5,3 [Led / Hal] max. 50W

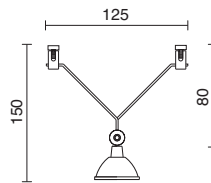

Lámparas recomendadas
Recommended lamps
Lampes recommandées
Lâmpadas recomendadas

LED PRO



pag. 261

- Lámpara no incluída.
- Lamp not included.
- Lampe exclue.
- Lâmpada não incluída.



Hara

164E-H18X1D-32 □

G53 [Led / Hal] max. 50W

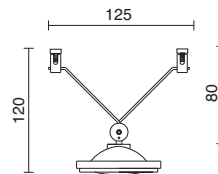

- Lámpara no incluída.
- Lamp not included.
- Lampe exclue.
- Lâmpada não incluída.

Acces. / Transform. Kable12, p. 165

Kable 12



Caf

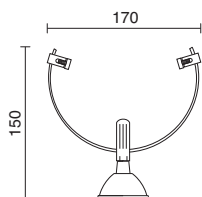

164F-G23X1D-32 □

GU5,3 [Led / Hal] max. 50W

- Altura ajustable.
- Adjustable height.
- Réglable en hauteur.
- Altura ajustável.



- Lámpara no incluida.
- Lamp not included.
- Lampe exclue.
- Lâmpada não incluida.



Zer

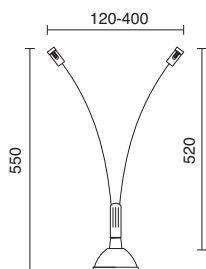

164G-G23X1D-32 □

GU5,3 [Led / Hal] max. 50W

- Altura ajustable.
- Adjustable height.
- Réglable en hauteur.
- Altura ajustável.

- Lámpara no incluida.
- Lamp not included.
- Lampe exclue.
- Lâmpada não incluida.

Lámparas recomendadas
Recommended lamps
Lampes recommandées
Lâmpadas recomendadas

LED PRO



pag. 261

Acces. / Transform. Kable12, p. 165

Kable 12



Devas

ACER

164C-G23X1D-32 □

GU5,3 [Led / Hal] max. 50W

Lámparas recomendadas.
Recommended lamps.
Lampes recommandées.
Lampadas recomendadas.

LED PRO



pag. 261

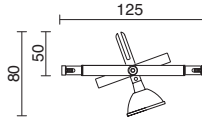

Acces. / Transform. Kable 12, p. 165



Kable 12 Accessories



12V
AC

B08A-X33X2D-03 ■

Cable de alimentación (venta por metros) Sección cable: 5,4mm².
Power cord (sold in meters), cord section: 5,4mm².
Cable d'alimentation (vendu au mètre) Section du câble: 5,4mm².
Cabo de alimentação (venda por metros) Secção cabo: 5,4mm².



12V
AC

B08H-X33X2D-03 ■

Juego de terminales de alimentación. Se suministra con 2x100cm de cable.
Set of power terminals. Supplied with 2x100cm sets of cord.
Jeu du bornes d'alimentation. Livré avec câble 2x100cm.
Jogo de terminais de alimentação. Fornece-se com 2x100cm de cabo.

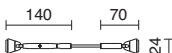
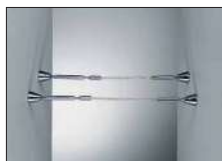

A15B-164-03 ■

Juego de soportes tensores.
Set of tensioning brackets.
Jeu de supports tenseurs.
Jogo de suportes tensores.

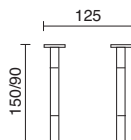

A15C-164-03 ■

Juego distanciadores techo.
Altura 15cm. (9cm prescindiendo del tramo central).
Set of ceiling deflectors.
Length 15cm. (9cm without the central section).
Jeu du séparateurs pour le plafond.
Hauteur 15cm (9cm en dehors du section centrale).
Jogo distanciadores de teto.
Altura 15cm. (9cm prescindindo do trecho central).

Transformadores / Transformers / Transformateurs / Transformadores **KABLE12**

pag. 268



B02M-X33A5D-03 ■

240/12V AC 200W IP 20 10,8x10,4x9,9cm

B02M-X33A9D-03 ■

240/12V AC 500W IP 20 12x13,2x10,8cm



B02F-X33A8D-32 □

230/12V AC 400W IP 20 22x11cm

*Para la utilización de estos transformadores se debe cambiar el PIA o magnetotérmico de una curva "C" a una curva "D" (curva lenta). Para más información consultar con el departamento técnico.

*For the use of these transformers you should change the MCB (Miniature Circuit Breaker) from a "C" curve to a "D" curve (slow curve). For more information, please consult the technical department.

*Pour utiliser ces transformateurs, c'est nécessaire de remplacer le disjoncteur magnéto-thermique à courbe "C" par un autre à courbe "D". Pour des renseignements complémentaires veuillez contacter notre département technique.

*Para a utilização destes transformadores deve-se mudar o PIA (Pequeno Interruptor Automático) ou magnetotérmico de uma curva "C" para uma curva "D" (curva lenta). Para mais informação consultar o departamento técnico.

Pie y sobremesa

Floor and table lamps

Lampadaires et lampes à poser

Pé e Mesa



new

Tess



837A-G05X1A-01 □

E27 [Led / Fluo / Hal] max. 60W

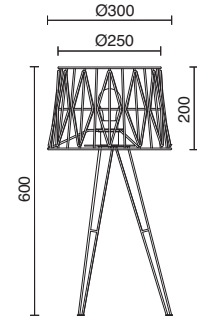

837B-G05X1A-01 □

E27 [Led / Fluo / Hal] max. 60W

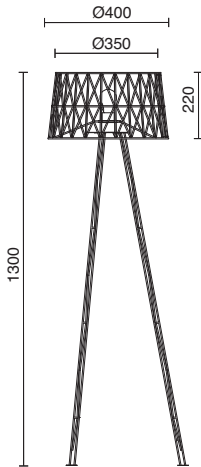

Lámparas recomendadas / Recommended lamps
Lampes recomandées / Lámpadas recomendadas

LED FILAMENT



pag. 260







Pantalla no incluida / Shade not included / Abat-Jour exclu / Abajur não incluído



717A-G05X1A-02 + A26F-004-CJ



717A-G05X1A-32 + A26F-004-CK



717A-G05X1A-02 + A26F-004-CA



717A-G05X1A-32 + A26F-004-HC

717A-G05X1A-02 ■

717A-G05X1A-32 □

E27 [Led / Fluo / Hal] max. 60W

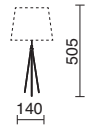

Pantallas disponibles / Available shades
Abat-Jours disponibles / Abajures disponíveis

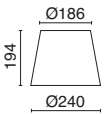

- A26F-004-CA
- A26F-004-CC
- A26F-004-CK
- A26F-004-CJ
- A26F-004-CE
- A26F-004-HC

▲
Otros acabados de pantalla bajo pedido, pag 273
Other shade finishes available upon request, pag 273
Autres finitions des abat-jours sur demande, pag 273
Outros acabamentos para os Abajures sob pedido, pag 273

Lámparas recomendadas / Recommended lamps
Lampes recommandées / Lâmpadas recomendadas

LED FILAMENT



pag. 260



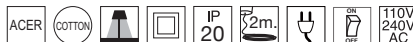

Pantalla no incluida / Shade not included / Abat-Jour exclu / Abajur não incluído

7 17B-G05X1A-02 ■

7 17B-G05X1A-32 □

E27 [Led / Fluo / Hal] max. 60W

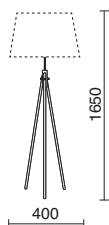

7 17B-G05X1A-02 + A26G-004-HC



7 17B-G05X1A-32 + A26G-004-CE

Pantallas disponibles / Available shades
Abat-jours disponibles / Abajures disponíveis

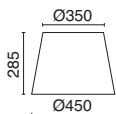

Lámparas recomendadas / Recommended lamps
Lampes recomendades / Lâmpadas recomendadas

LED FILAMENT



pag. 260

A26G-004-CA □

A26G-004-CC ■

A26G-004-CK ■

A26G-004-CJ ■

A26G-004-CE ■

A26G-004-HC ■



Otros acabados de pantalla bajo pedido, pag 273
Other shade finishes available upon request, pag 273
Autres finitions des abat-jours sur demande, pag 273
Outros acabamentos para os Abajures sob pedido, pag 273



p. 80



p. 82



p. 134

02 Negro / Black / Noir / Preto 32 Cromo / Chrome / Chrom / Cromo

CA Cotton White CC Cotton Beige CE Cotton Capuccino CJ Cotton Red CK Cotton Grey HC Yute Beige

new

Lars

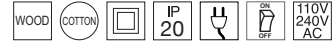

Pantalla no incluida / Shade not included / Abat-Jour exclu / Abajur não incluído



845A-G05X1A-50

E27 [Led / Fluó / Hal] max. 60W

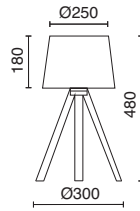
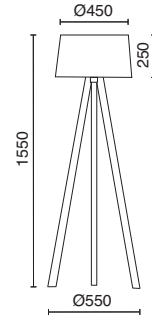

845B-G05X1A-50

E27 [Led / Fluó / Hal] max. 60W



Pantallas disponibles / Available shades
Abat-Jours disponibles / Abajures disponíveis

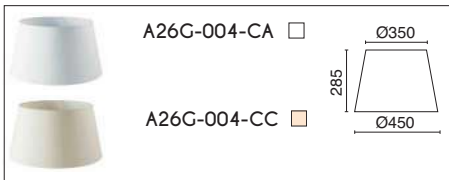

Pantallas disponibles / Available shades
Abat-Jours disponibles / Abajures disponíveis

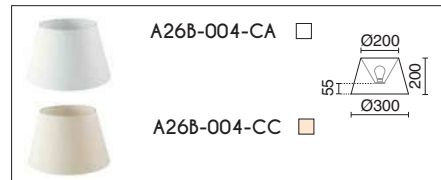

▲ Otros acabados de pantalla bajo pedido, pag 273 / Other shade finishes available upon request, pag 273
Autres finitions des abat-jours sur demande, pag 273 / Outros acabamentos para os Abajures sob pedido, pag 273



Wood

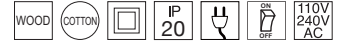

Pantalla no incluida / Shade not included / Abat-Jour exclu / Abajur não incluído

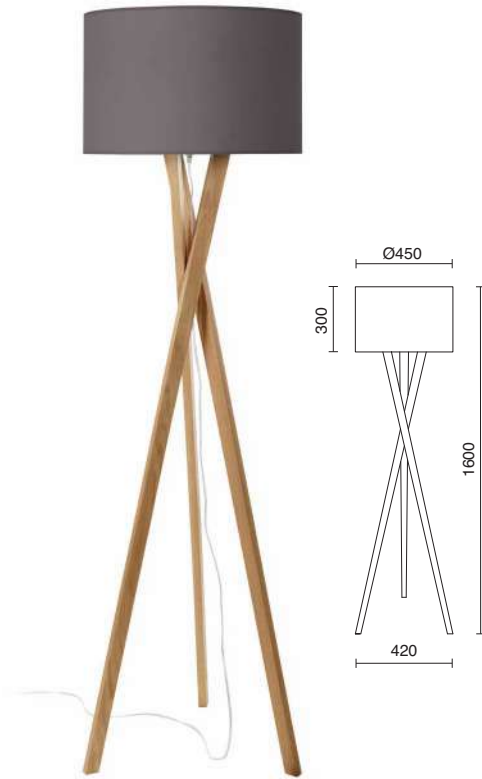

621A-C05X1A-50 + A29B-004-CG

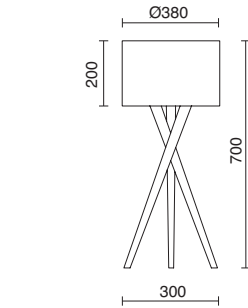

621B-C05X1A-50 + A29C-004-DC



621A-C05X1A-50

E27 [Led / Fluo / Hal] max. 60W



621B-C05X1A-50

E27 [Led / Fluo / Hal] max. 60W



Pantallas disponibles / Available shades
Abat-Jours disponibles / Abajures disponíveis

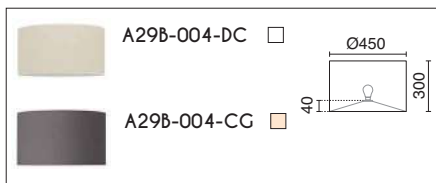

Pantallas disponibles / Available shades
Abat-Jours disponibles / Abajures disponíveis

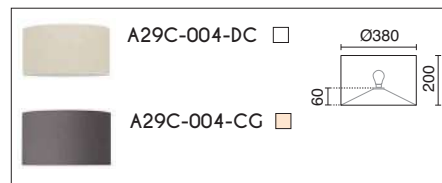

Lámparas recomendadas / Recommended lamps
Lampes recommandées / Lâmpadas recomendadas

LED FILAMENT



pag. 260

▲ Otros acabados de pantalla bajo pedido, pag 273 / Other shade finishes available upon request, pag 273
Autres finitions des Abat-jours sur demande, pag 273 / Outros acabamentos para os Abajures sob pedido, pag 273



Kara



Pantalla no incluida / Shade not included / Abat-Jour exclu / Abajur não incluído

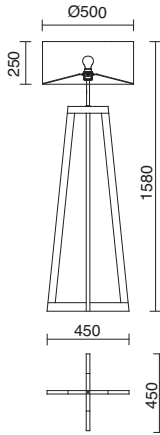

703A-G05X1A-51 ■

E27 [Led / Fluo / Hal] max. 60W



Lámparas recomendadas / Recommended lamps
Lampes recommandées / Lâmpadas recomendadas

LED FILAMENT



pag. 260

Pantalla disponible / Available shade
Abat-Jour disponible / Abajur disponível

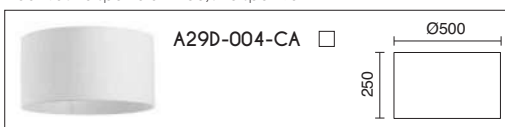

▲ Otros acabados de pantalla bajo pedido, pag 273 / Other shade finishes available upon request, pag 273
Autres finitions des Abat-jours sur demande, pag 273 / Outros acabamentos para os Abajures sob pedido, pag 273





Britta



Pantalla no incluida / Shade not included / Abat-Jour exclu / Abajur não incluído

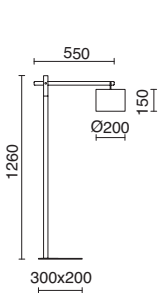

68 1C-G05X 1A-02 ■

E27 [Led / Fluo / Hal] max. 60W

Pantalla disponible / Available shade
Abat-Jour disponible / Abajur disponível

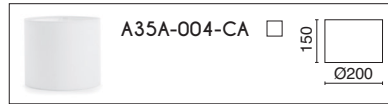

▲ Otros acabados de pantalla bajo pedido, pag 273
Other shade finishes available upon request, pag 273
Autres finitions des abat-jours sur demande, pag 273
Outros acabamentos para os Abajures sob pedido, pag 273



68 1B-G05X 1A-02 ■

E27 [Led / Fluo / Hal] max. 60W

Pantalla disponible / Available shade
Abat-Jour disponible / Abajur disponível

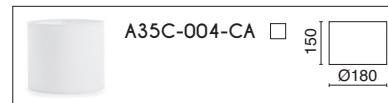

▲ Otros acabados de pantalla bajo pedido, pag 273
Other shade finishes available upon request, pag 273
Autres finitions des abat-jours sur demande, pag 273
Outros acabamentos para os Abajures sob pedido, pag 273



68 1B-G05X 1A-02 + A35A-004-CA

68 1C-G05X 1A-02 + A35C-004-CA



p. 77

Lámparas recomendadas / Recommended lamps
Lampes recommandées / Lâmpadas recomendadas

LED FILAMENT



pag. 260



Gram

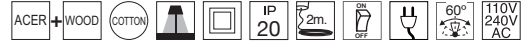

Pantalla no incluida / Shade not included / Abat-Jour exclu / Abajur não incluido



688A-C05X1A-51 ■

E27 [Led / Fluo / Hal] max. 60W

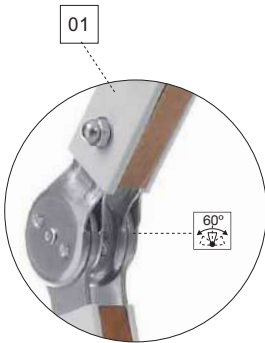

Lámparas recomendadas / Recommended lamps
Lampes recommandées / Lâmpadas recomendadas

LED FILAMENT



pag. 260

Pantalla disponible / Available shade
Abat-Jour disponible / Abajur disponível

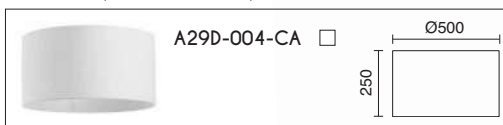

▲ Otros acabados de pantalla bajo pedido, pag 273 / Other shade finishes available upon request, pag 273
Autres finitions des Abat-jours sur demande, pag 273 / Outros acabamentos para os Abajures sob pedido, pag 273



Skandia

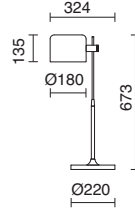
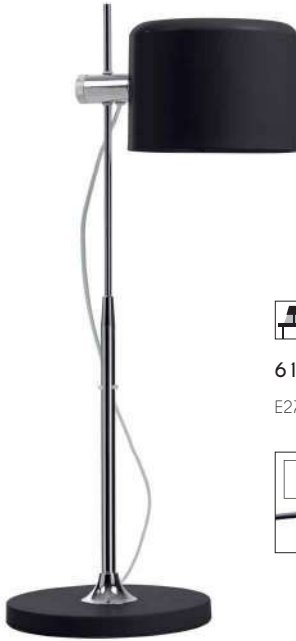

614A-G05X1A-02 ■

E27 [Led / Fluo / Hal] max. 60W



- Altura ajustable.
- Adjustable height.
- Réglable en hauteur.
- Altura ajustável.

Lámparas recomendadas / Recommended lamps
Lampes recommandées / Lâmpadas recomendadas

LED FILAMENT



pag. 260

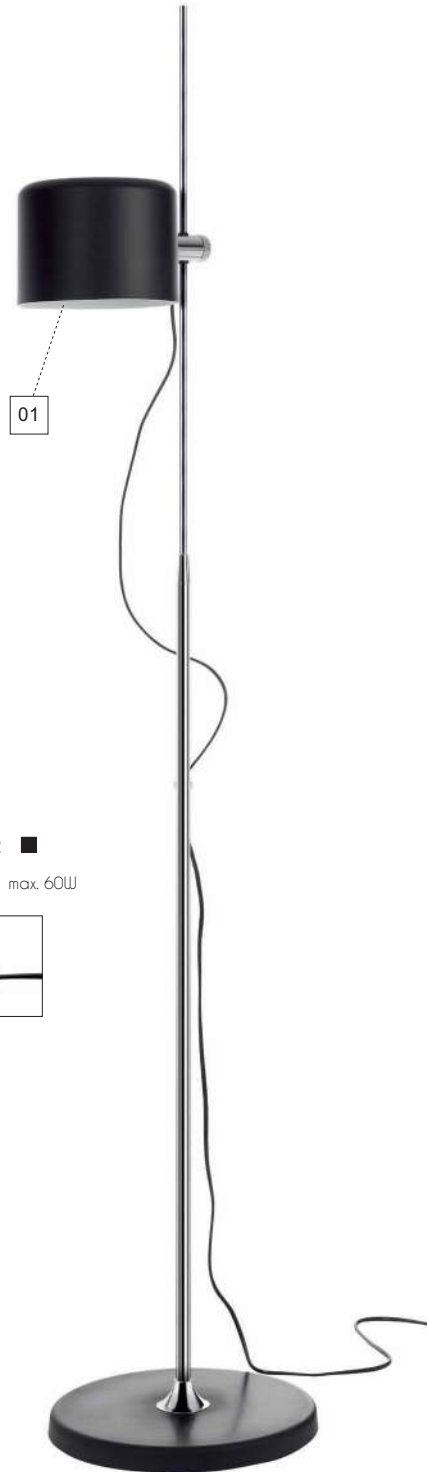

614B-G05X1A-02 ■

E27 [Led / Fluo / Hal] max. 60W

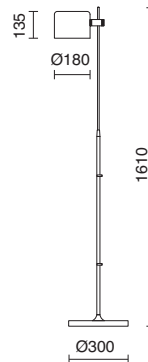



Spin



Pantalla no incluida / Shade not included / Abat-Jour exclu / Abajur não incluído

615A-G05X1A-32

E27 [Led / Fluo / Hal] max. 60W



Pantallas disponibles / Available shades / Abat-Jours disponibles / Abajures disponíveis



▲ Otros acabados de pantalla bajo pedido, pag 273 / Other shade finishes available upon request, pag 273
Autres finitions des Abat-jours sur demande, pag 273 / Outros acabamentos para os Abajures sob pedido, pag 273

Lámparas recomendadas / Recommended lamps
Lampes recomendades / Lâmpadas recomendadas

LED FILAMENT



pag. 260

Base de mármol
Marble base
Pied en marbre
Base de mármore

02

615A-G05X1A-32 + A32A-004-CA



Zanzibar



622A-G05X1A-02 ■

E27 [Led / Fluo / Hal] max. 60W

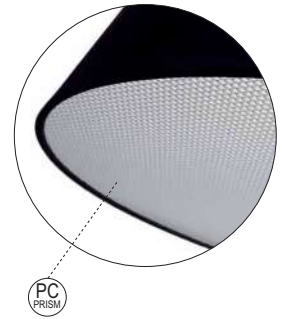
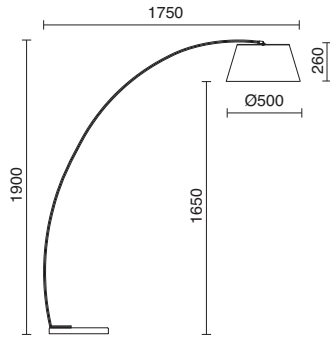
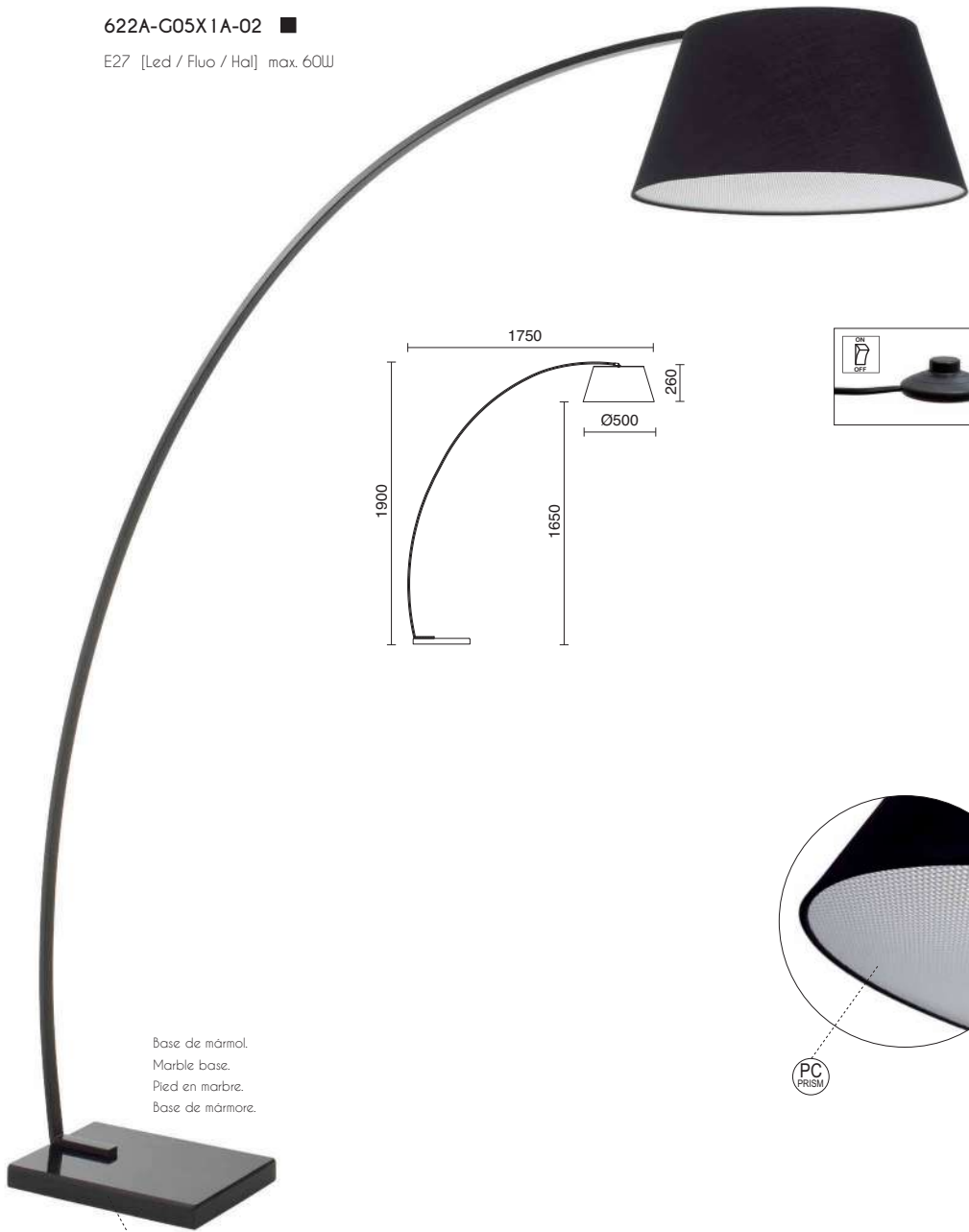

Base de mrmar.
 Marble base.
 Pied en marbre.
 Base de mrmore.

02

Lmparas recomendadas / Recommended lamps
 Lampes recommandes / Lmpadas recomendadas

LED FILAMENT



pag. 260



Maui



607A-G05X1A-35 ■

E27 [Led / Fluo / Hal] max. 60W

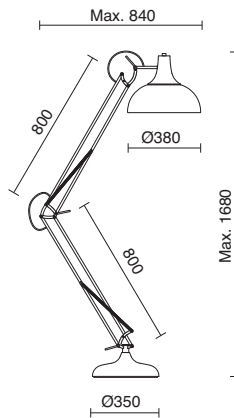
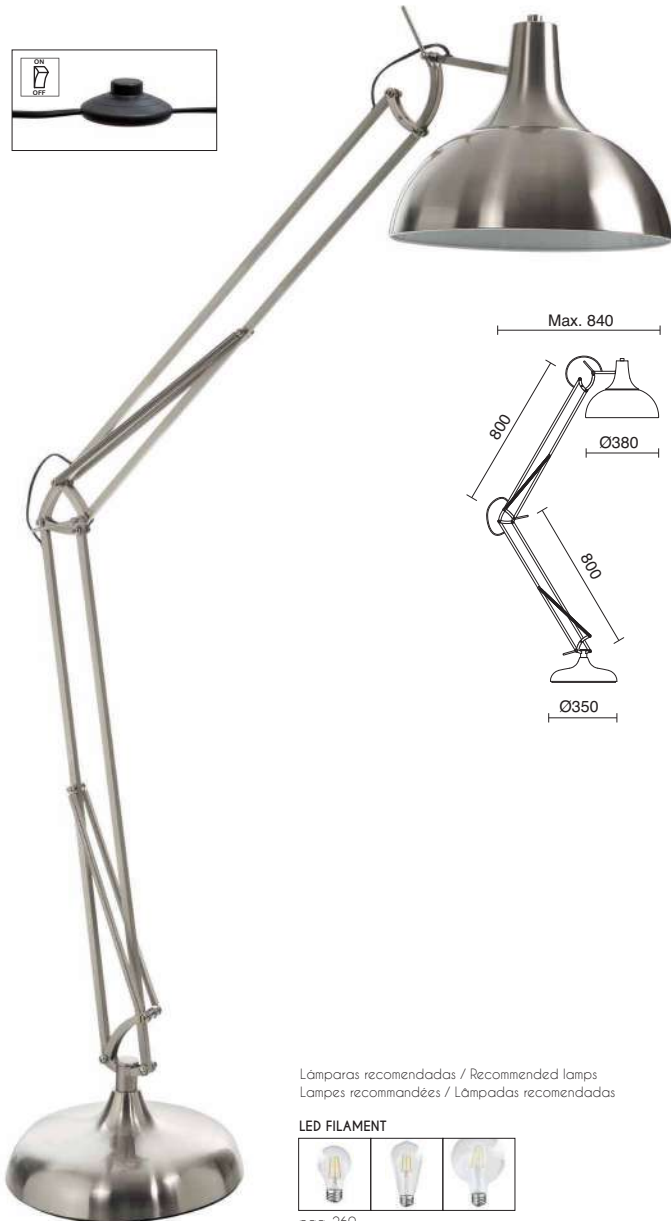

Lámparas recomendadas / Recommended lamps
Lampes recommandées / Lâmpadas recomendadas

LED FILAMENT



pag. 260





new

Valan

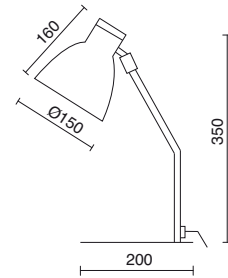

846C-G05X1A-01 □

E27 [Led / Fluo / Hal] max. 60W

Lámpara recomendada / Recommended lamp
Lampe recommandée / Lâmpada recomendada

LED FILAMENT



pág. 260





Cloé

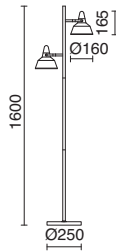
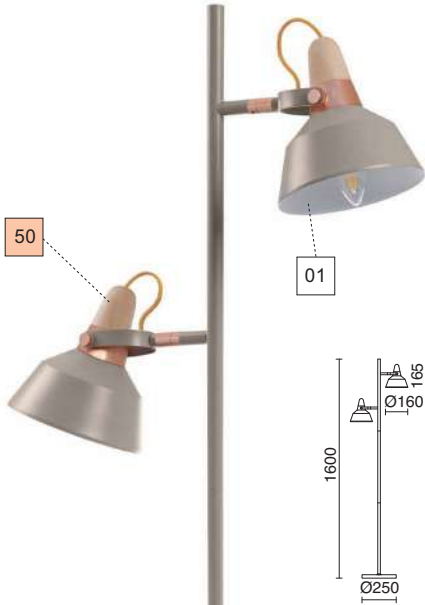
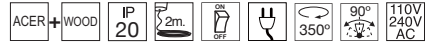

680D-G04X1A-13 ■

2x E14 [Led / Fluo / Hal] max. 40W

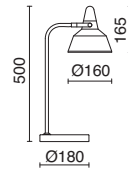

680E-G04X1A-13 ■

E14 [Led / Fluo / Hal] max. 40W



Lámparas recomendadas
Recommended lamps
Lampes recommandées
Lâmpadas recomendadas

LED FILAMENT



pag. 260





Oma

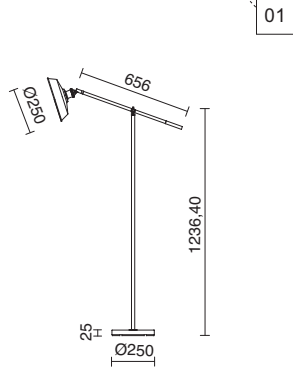
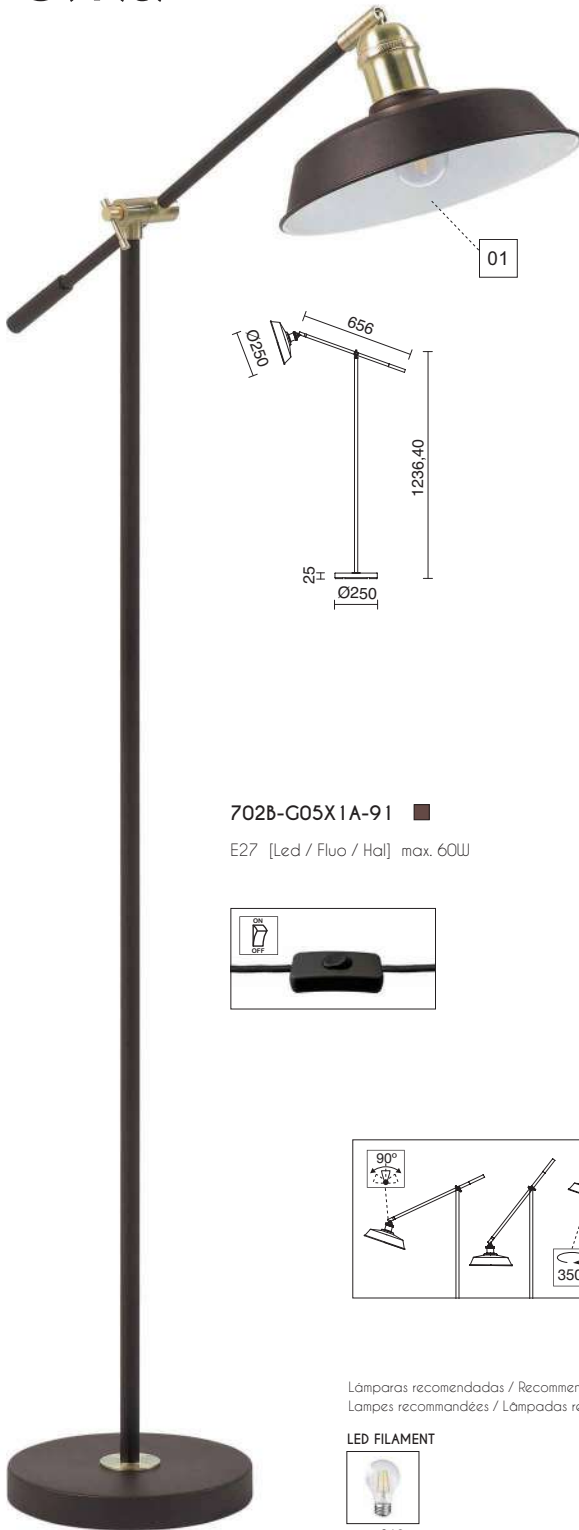

702A-G05X1A-91 ■

E27 [Led / Fluo / Hal] max. 60W



702B-G05X1A-91 ■
E27 [Led / Fluo / Hal] max. 60W

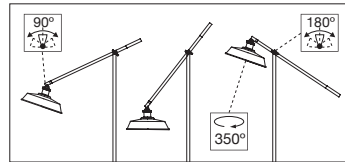
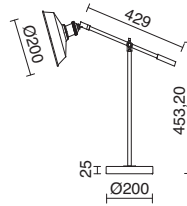

Lámparas recomendadas / Recommended lamps
Lampes recommandées / Lâmpadas recomendadas

LED FILAMENT



pag. 260



Astrid



701B-G05X1A-91 ■

E27 [Led / Fluo / Hal] max. 60W

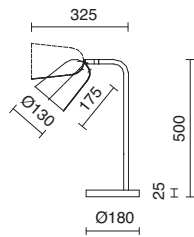

701A-G05X1A-91 ■

E27 [Led / Fluo / Hal] max. 60W

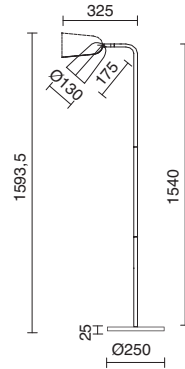
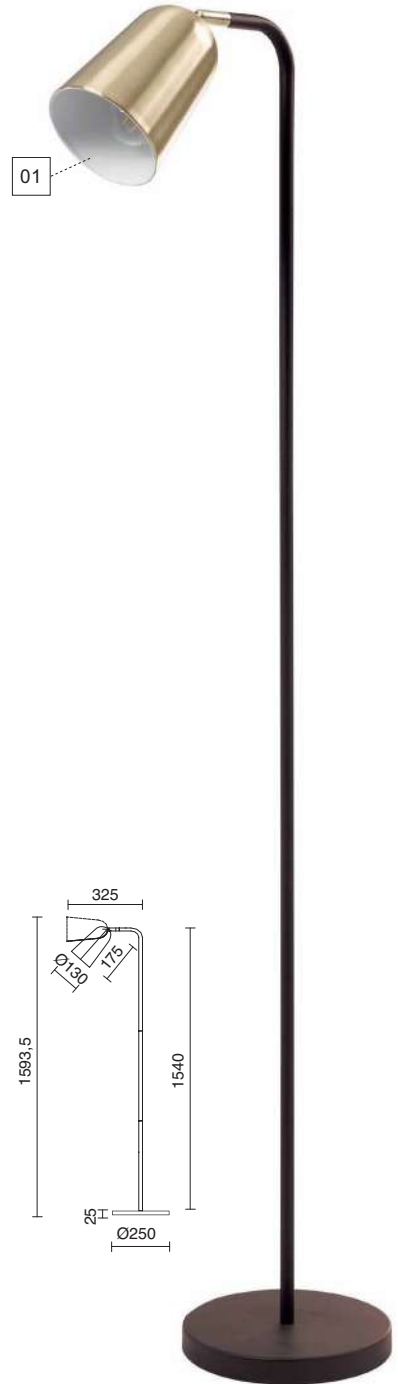

Lámparas recomendadas / Recommended lamps
Lampes recommandées / Lámpadas recomendadas

LED FILAMENT



pag. 260



Foc



679A-L0129B-35 

LED 28,6W 2000lm 3000K





Flama



598A-LO124B-35 ■

LED 24W 2100lm 3000K

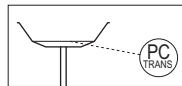



Albero



633A-L01H8A-35

LED 30W 2400lm 3000K
 +
 LED 5W 400lm 3000K

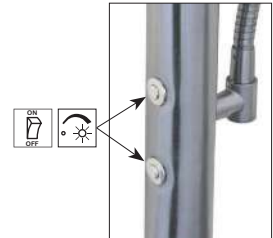
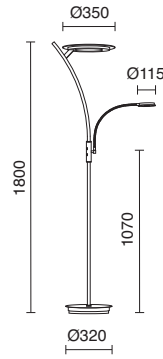



Study

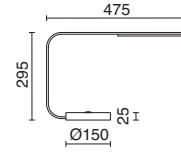

617A-L0105A-39 ■

LED 5W 280lm 3000K



Book

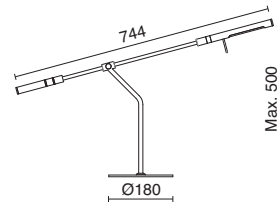

588B-L0104A-02 ■

LED 5W 280lm 3000K

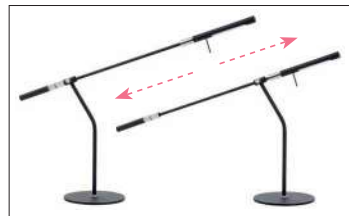



Iris



Pantalla no incluida / Shade not included / Abat-Jour exclu / Abajur não incluído



602A-G05X1A-35 + A33A-004-CA

602A-G05X1A-32

E27 [Led / Fluo / Hal] max. 60W

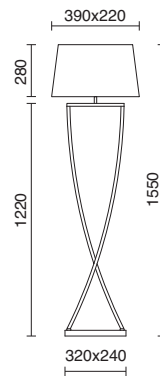

Pantallas disponibles / Available shades
Abat-Jours disponibles / Abajures disponíveis

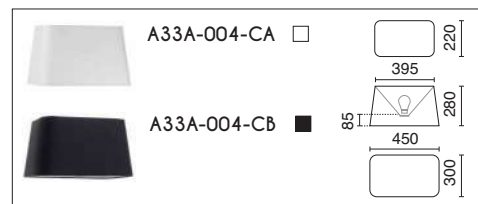

▲ Otros acabados de pantalla bajo pedido, pag 273
Other shade finishes available upon request, pag 273
Autres finitions des Abat-jours sur demande, pag 273
Outros acabamentos para os Abajures sob pedido, pag 273

Lámparas recomendadas / Recommended lamps
Lampes recommandées / Lâmpadas recomendadas

LED FILAMENT



pag. 260

Iris



Pantalla no incluida / Shade not included / Abat-Jour exclu / Abajur não incluído

602B-G05X1A-32

E27 [Led / Fluo / Hal] max 60W

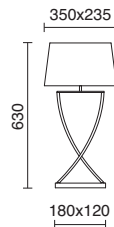

Pantallas disponibles / Available shades
Abat-Jours disponibles / Abajures disponíveis

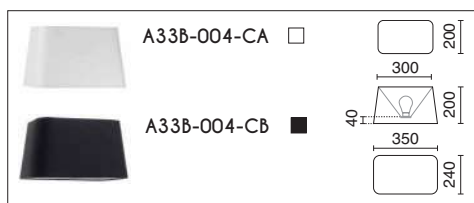

602B-G05X1A-32 + A33B-004-CB

Lámparas recomendadas
Recommended lamps
Lampes recommandées
Lâmpadas recomendadas

LED FILAMENT



pag. 260

▲ Otros acabados de pantalla bajo pedido, pag 273
Other shade finishes available upon request, pag 273
Autres finitions des Abat-jours sur demande, pag 273
Outros acabamentos para os Abajures sob pedido, pag 273



Firenze



Pantalla no incluida / Shade not included / Abat-Jour exclu / Abajur não incluído



507C-G05X1A-35 + A26C-004-CC

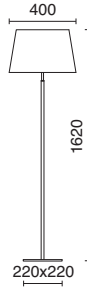

507C-G05X1A-35

E27 [Led / Fluo / Hal] max. 60W

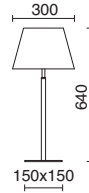

507D-G05X1A-35 + A26B-004-CC



507D-G05X1A-35

E27 [Led / Fluo / Hal] max. 60W



Pantallas disponibles / Available shades
Abat-Jours disponibles / Abajures disponíveis

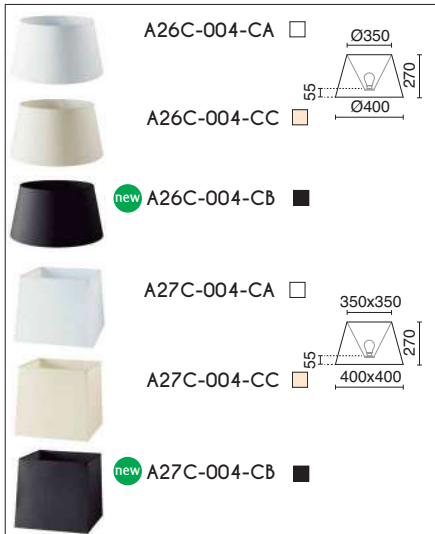

Pantallas disponibles / Available shades
Abat-Jours disponibles / Abajures disponíveis



p. 86

Lámparas recomendadas
Recommended lamps
Lampes recommandées
Lâmpadas recomendadas

LED FILAMENT



pag. 260

▲ Otros acabados de pantalla bajo pedido, pag 273
Other shade finishes available upon request, pag 273
Autres finitions des Abat-jours sur demande, pag 273
Outros acabamentos para os Abajures sob pedido, pag 273



Eda



Pantalla no incluida / Shade not included / Abat-Jour exclu / Abajur não incluído



596C-Y05X1A-32 + A26B-004-CC



596C-Y05X1A-32 □

E27 [Led / Fluo / Hal] max. 60W

+ LED 3W 240lm 3000K

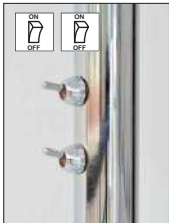

596B-Y05X1A-32 □

E27 [Led / Fluo / Hal] max. 60W

+ LED 3W 240lm 3000K

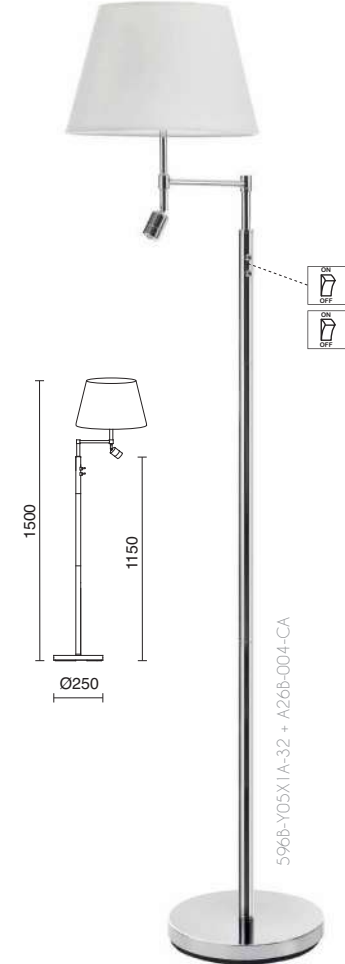

596b-Y05X1A-32 + A26b-004-CA

Pantallas disponibles / Available shades / Abat-Jours disponibles / Abajures disponiveis

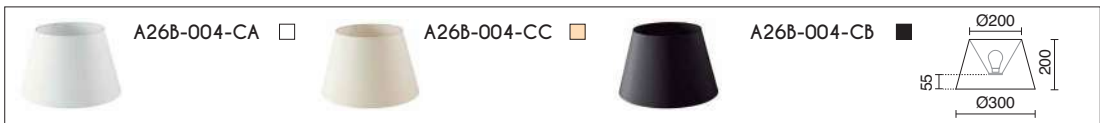

▲ Otros acabados de pantalla bajo pedido, pag 273 / Other shade finishes available upon request, pag 273
Autres finitions des Abat-jours sur demande, pag 273 / Outros acabamentos para os Abajures sob pedido, pag 273



Lámparas recomendadas / Recommended lamps
Lampes recommandées / Lâmpadas recomendadas

LED FILAMENT



pag. 260



Oval



Pantalla no incluida / Shade not included / Abat-Jour exclu / Abajur não incluido



611F-G05X1A-35 + A28A-004-CC

611F-G05X1A-35 ■

E27 [Led / Fluo / Hal] max. 60W

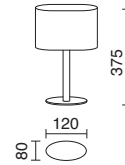

Pantallas disponibles / Available shades
Abat-Jours disponibles / Abajures disponibles

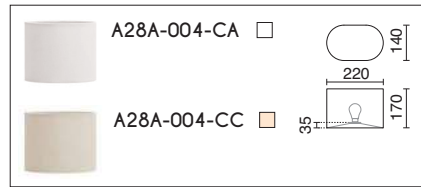

▲ Otros acabados de pantalla bajo pedido, pag 273
Other shade finishes available upon request, pag 273
Autres finitions des Abat-jours sur demande, pag 273
Outros acabamentos para os Abajures sob pedido, pag 273

611E-G05X1A-35 ■

E27 [Led / Fluo / Hal] max. 60W



Pantallas disponibles / Available shades
Abat-Jours disponibles / Abajures disponibles

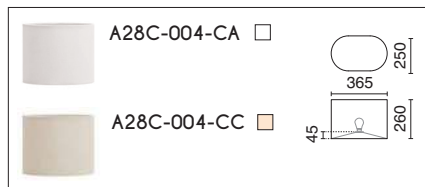

▲ Otros acabados de pantalla bajo pedido, pag 273
Other shade finishes available upon request, pag 273
Autres finitions des Abat-jours sur demande, pag 273
Outros acabamentos para os Abajures sob pedido, pag 273



611E-G05X1A-35 + A28C-004-CC



Lámparas recomendadas / Recommended lamps
Lampes recommandées / Lâmpadas recomendadas

LED FILAMENT



pag. 260

Oval



Pantalla no incluida / Shade not included / Abat-Jour exclu / Abajur não incluído

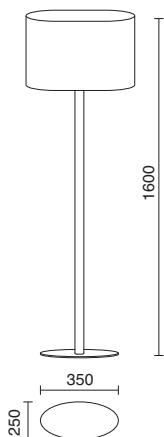

61 ID-G05X1A-35

E27 [Led / Fluo / Hal] max. 60W



Pantallas disponibles / Available shades
Abat-Jours disponibles / Abajures disponíveis

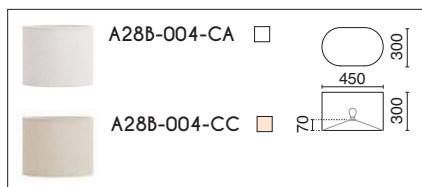

▲ Otros acabados de pantalla bajo pedido, pag 273
Other shade finishes available upon request, pag 273
Autres finitions des Abat-jours sur demande, pag 273
Outros acabamentos para os Abajures sob pedido, pag 273

Lámparas recomendadas / Recommended lamps
Lampes recommandées / Lâmpadas recomendadas

LED FILAMENT



pag. 260



61 ID-G05X1A-35 + A28B-004-CA

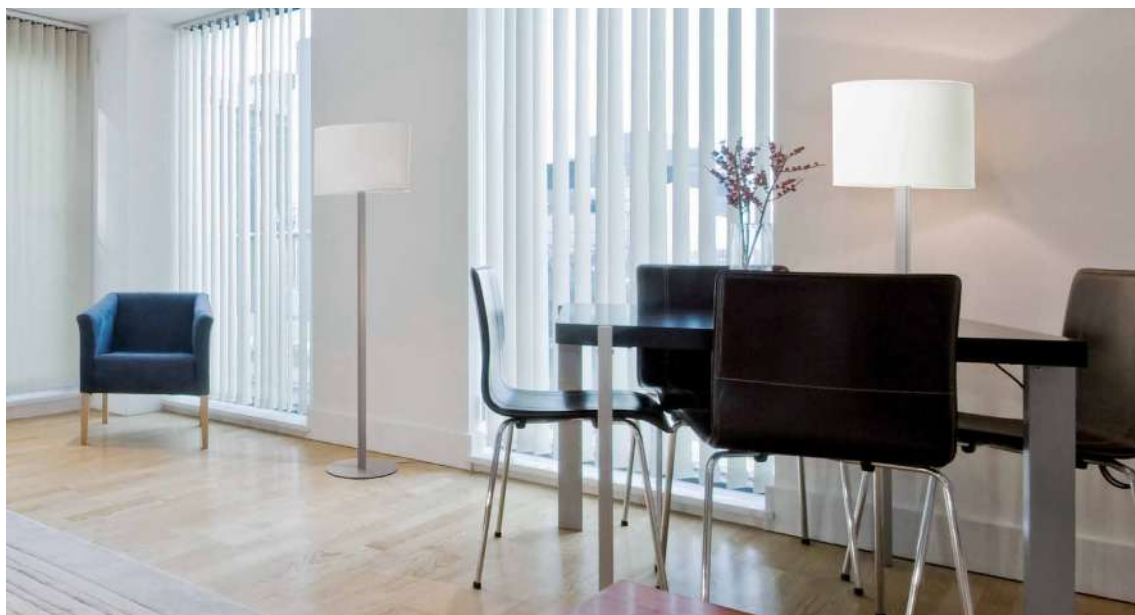

Gina



Pantalla no incluida / Shade not included / Abat-Jour exclu / Abajur não incluido

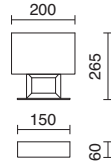

600F-G05X1A-35 ●

E27 [Led / Fluo / Hal] max. 60W



600F-G05X1A-35 + A36C-004-CC

Pantallas disponibles / Available shades / Abat-Jours disponibles / Abajures disponíveis



▲ Otros acabados de pantalla bajo pedido, pag 273 / Other shade finishes available upon request, pag 273
Autres finitions des Abat-jours sur demande, pag 273 / Outros acabamentos para os Abajures sob pedido, pag 273

600E-G05X1A-35 ●

E27 [Led / Fluo / Hal] max. 60W

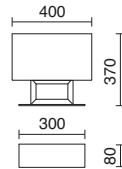

600E-G05X1A-35 + A36B-004-CA

Pantallas disponibles / Available shades / Abat-Jours disponibles / Abajures disponíveis



▲ Otros acabados de pantalla bajo pedido, pag 273 / Other shade finishes available upon request, pag 273
Autres finitions des Abat-jours sur demande, pag 273 / Outros acabamentos para os Abajures sob pedido, pag 273



p. 92

Lámparas recomendadas / Recommended lamps
Lampes recommandées / Lâmpadas recomendadas

LED FILAMENT



pag. 260

Gina



Pantalla no incluida / Shade not included / Abat-Jour exclu / Abajur não incluído

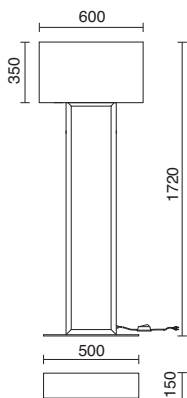

600D-G05X1A-35 ●

2x E27 [Led / Fluó / Hal] max. 60W



Pantallas disponibles / Available shades
Abat-Jours disponibles / Abajures disponíveis

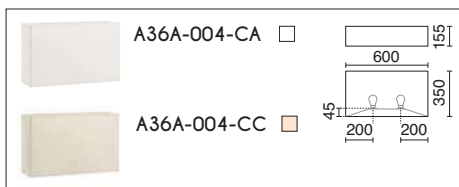

▲ Otros acabados de pantalla bajo pedido, pag 273
Other shade finishes available upon request, pag 273
Autres finitions des Abat-jours sur demande, pag 273
Outros acabamentos para os Abajures sob pedido, pag 273

Lámparas recomendadas / Recommended lamps
Lampes recommandées / Lâmpadas recomendadas

LED FILAMENT



pag. 260



Baño

Bathroom

Salle de bain

Banho



Iluminación y seguridad en el baño

- ZONA 1** Las luminarias tienen que estar protegidas contra los chorros de agua. Mínimo luminarias con IPX5.
- ZONA 2** Las luminarias tienen que estar protegidas contra las salpicaduras de agua. Mínimo luminarias con IPX4 o superior.
- ZONA 3** No existen condiciones especiales de IP para esta zona.

Bathroom lighting and safety

- ZONE 1** Protection against water jets. IPX5 or above required.
- ZONE 2** Protection from water splashing. IPX4 or above required.
- ZONE 3** No-special restrictions of IP protection.

Éclairage et sécurité dans la salle de bain

- ZONE 1** Les luminaires doivent être protégés contre les jets d'eau. Minimum IPX5.
- ZONE 2** Les luminaires doivent être protégés contre les projections d'eau. Minimum IPX4 ou plus.
- ZONE 3** Il n'y a pas de conditions spéciales de protection IP.

Iluminação e segurança no banheiro

- ZONA 1** Luminárias devem ser protegidos contra jatos de água. Mínimos IPX5.
- ZONA 2** luminárias deve ser protegido contra salpicos de água. Luminárias mínimos com IPX4 ou superior.
- ZONA 3** Não há condições especiais IP para esta área.

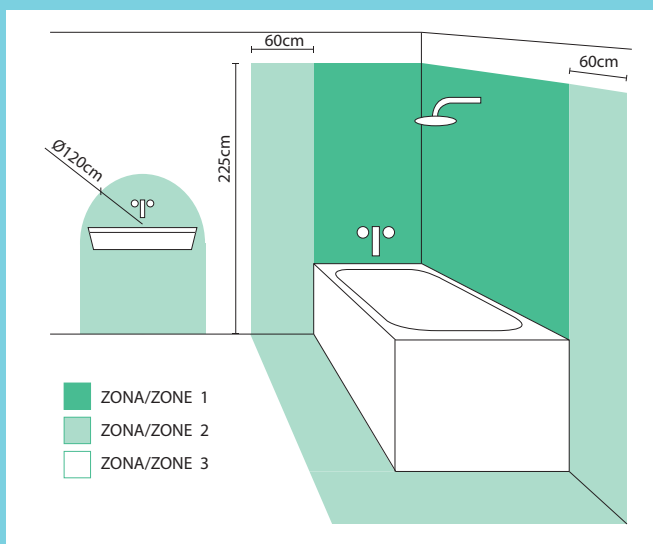

Krystal

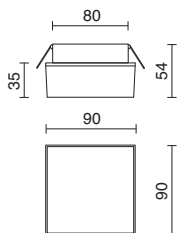

Ø80

Instalación en placa yeso.
Installation in plasterboard.
Installation sur plaque à plâtre.
Instalação em gesso cartonado.

511A-L0103H-29 □

LED 3W 240lm 3000K



Alimentador / Power supply / Alimentateur / Alimentador



pag. 268

Dik

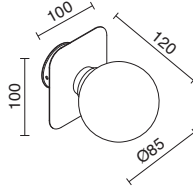

591B-LO104A-32 □

LED 4W 280lm 3000K

591A-LO1H5A-32 □

LED 3x 4W 840lm 3000K

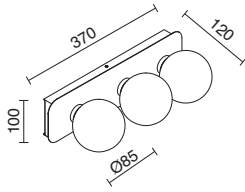

Sun



623A-LO103A-32 □

LED 3W 240lm 3000K

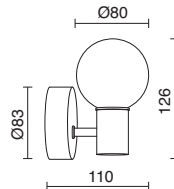



Vel



493A-G04X IA-32 □

E14 [Led / Fluo / Hal] max. 40W

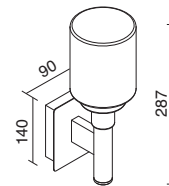

Lámparas recomendadas
 Recommended lamps
 Lampes recommandées
 Lâmpadas recomendadas

LED FILAMENT



pag. 260

Uveg



495A-G04X1A-28 □

E14 [Led / Fluo / Hal] max. 40W

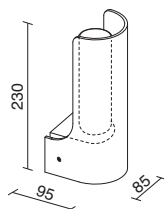

Bath Classic



712A-G04X1A-46 □

E14 [Led / Fluo / Hal] max. 40W

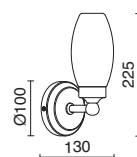

Lámparas recomendadas
Recommended lamps
Lampes recommandées
Lâmpadas recomendadas

LED FILAMENT



pag. 260

Bath

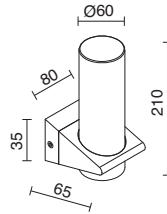

496A-G04X1A-32 □

E14 [Led / Fluo / Hal] max. 40W



496B-G04X1A-32 □

E14 [Led / Fluo / Hal] max. 40W

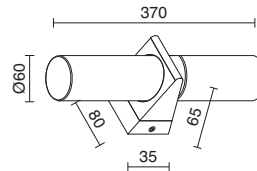

Lámparas recomendadas
Recommended lamps
Lampes recommandées
Lâmpadas recomendadas

LED FILAMENT



pag. 260



Friss



508A-F02B7B-32 □

2G11 TC-L 2x 18W

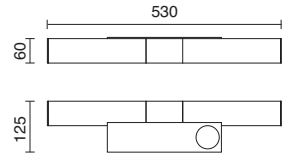

Sheid



513A-L0109B-32 □

LED 9W 720lm 3000K

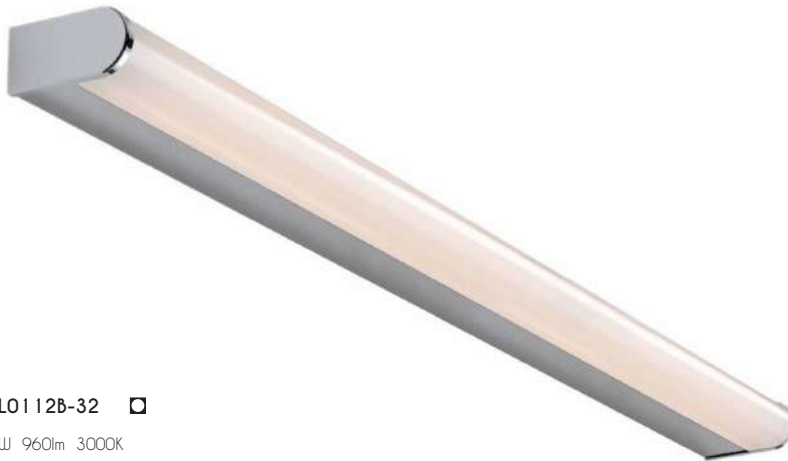
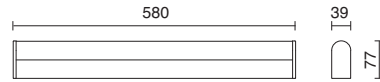

513B-L0112B-32 □

LED 12W 960lm 3000K

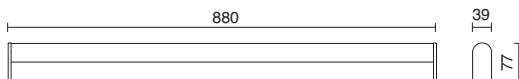

Lits



514A-L0109A-32 □

LED 9W 720lm 3000K

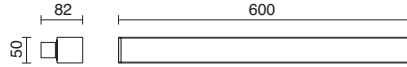

514B-L0112A-32 □

LED 12W 960lm 3000K

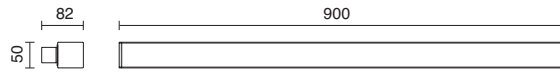

Desio



494A-G3 1X1A-32 □

GX53 T2 3x 3W / 4W / 6W

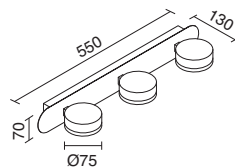

Lámpara recomendada
Recommended lamp
Lampe recommandée
Lâmpada recomendada

LED T2



pag. 259

Alf



696A-L0107A-32 □

LED 7W 430lm 3000K

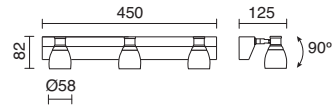

Dot



707A-L0105A-32 □

LED 3W 240lm 4000K

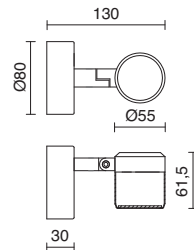

Moon

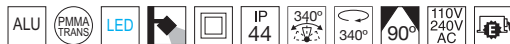

606A-L0105A-01 □

LED 5W 450lm 3000K

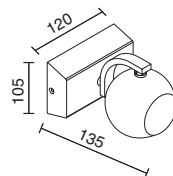

606B-L01G2A-01 □

2x LED 5W 450lm 3000K

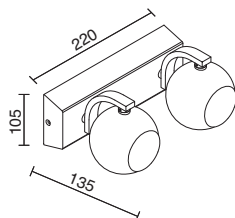

Tek



32

677A-L0205B-32 □

LED 6,5W 450lm 4000K

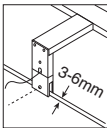
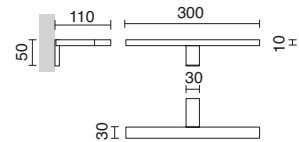

Clip de instalación en espejo incluido.
 Clip de instalação no espelho incluído.
 Mirror installation clip included.
 Clip d'installation du miroir inclus.

Alin



32

678A-L0206B-32 □

LED 7W 400lm 4000K

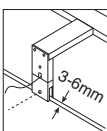
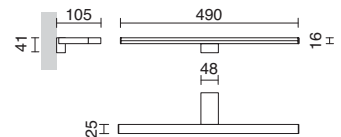

Clip de instalación en espejo incluido.
 Clip de instalação no espelho incluído.
 Mirror installation clip included.
 Clip d'installation du miroir inclus.



Tiel



515A-L01D2B-32 □

LED 3x 3W 720lm 3000K

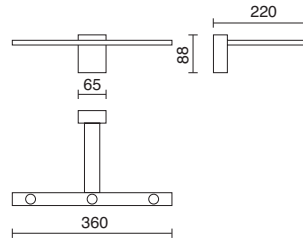

515B-L0103B-32 □

LED 3W 240lm 3000K

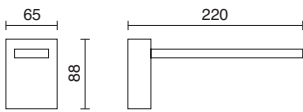



exo

Nat-Led

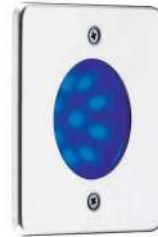
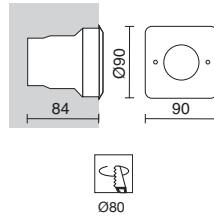

213A-L0102F-30 ■

LED 1,5W 3000K

213A-L1002F-30 ■

LED 1,5W

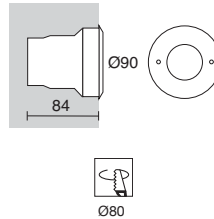

213B-L0102F-30 ■

LED 1,5W 3000K

213B-L1002F-30 ■

LED 1,5W

Alimentadores / Power supplies / Alimentateurs / Alimentadores



pag. 269



pag. 269



Roma

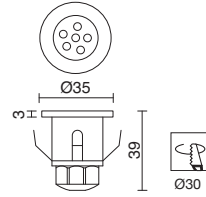

367A-L03E 1D-30 ■

LED 6x 0,1W 6000K

Instalación en placa yeso.
Installation in plasterboard.
Installation sur plaque à plâtre.
Instalação em gesso cartonado.



No precisa caja de empotrar.
Recessing box is not necessary.
Boîtier d'encastrement n'est pas nécessaire.
No precisa caixa embutida.

Alimentador / Power supply / Alimentateur / Alimentador

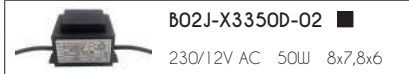

pag. 268



Ventiladores

Ceiling fans
Ventilateurs
Fãs



Fujil

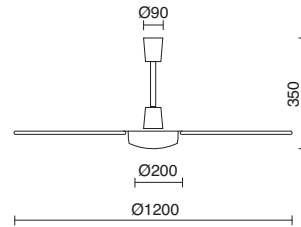
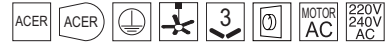

638A-VX60B-01 □

22,6W - 32,2W - 39,2W - 43,7W - 60W

RPM 195 - 256 - 290 - 307 - 330

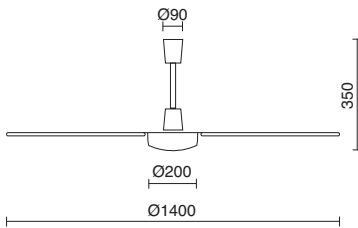

638B-VX82B-01 □

25,8W - 33,5W - 39,8W - 44,2W - 66,3W

RPM 148 - 187 - 207 - 247 - 295

Instalar en techos altos o naves.
Install in high ceilings or industrial premises.
Instaler en plafonds élevés.
Instalado em tectos altos ou naves industriais.

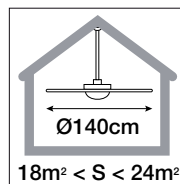
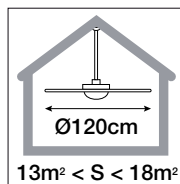
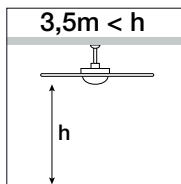

Cefiro



637A-WL90B-07 ■

18W - 48,6W - 90,7W

RPM 64 - 115 - 163

LED 18W 1800lm 3000K

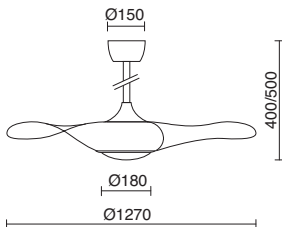

- 2 alturas (40 o 50cm totales) mediante dos tijas incluidas.
- 2 heights (40 or 50cm total) with two rods included.
- 2 hauteurs (40 ou 50cm totale) avec deux tiges incluses.
- 2 alturas (40 o 50cm totales) mediante dos extensões incluído.

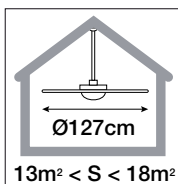
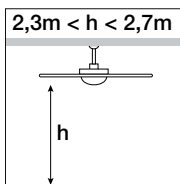

- Acabado rojo transparente.
- Transparent red finishing.
- Finition rouge transparent.
- Acabamento transparente vermelho.



Vento

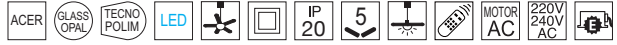

636A-WL75B-51 ■

17,6W - 43,9W - 75W

RPM 89 - 148 - 192

LED 17W 1700lm 3000K

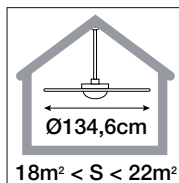
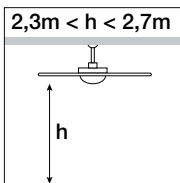
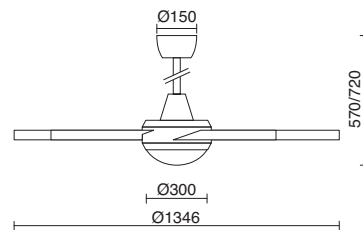

2 alturas (57 o 72cm totales) mediante dos tijas incluidas.
 2 heights (57 or 72cm total) with two rods included.
 2 hauteurs (57 ou 72cm totale) avec deux tiges incluses.
 2 alturas (57 o 72cm totales) mediante dos extensões incluído.



Marinada



635A-WL58B-01 □

635A-WL58B-03 ■

21,4W - 42,9W - 57,9W

RPM 112 - 175 - 208

LED 13W 1300lm 3000K

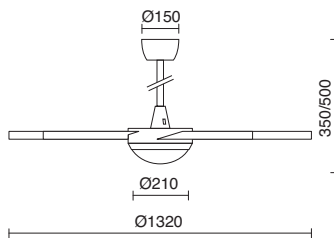

- 2 alturas (35 o 50cm totales) mediante dos tijas incluidas.
- 2 heights (35 or 50cm total) with two rods included.
- 2 hauteurs (35 ou 50cm totale) avec deux tiges incluses.
- 2 alturas (35 o 50cm totales) mediante dos extensões incluido.

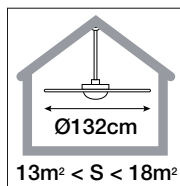
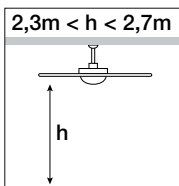



GNX

Led strip in



464A-L0124F-00 3000°K
464A-L0224F-00 4000°K
 LED 60leds/m 4,8W/m 360lm/m

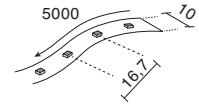

* **464B-L0105F-00** 3000°K
464B-L0205F-00 4000°K
 LED 60leds/m 4,8W/m 360lm/m

Alimentadores / Power supplies / Alimentateurs / Alimentadores



(Pag. 269)



464A-L0172F-00
 LED 60leds/m 3000°K 14,4W/m 1260lm/m

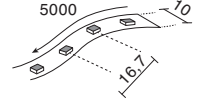

* **464B-L0115F-00**
 LED 60leds/m 3000°K 14,4W/m 1260lm/m

Alimentadores / Power supplies / Alimentateurs / Alimentadores



(Pag. 269)



464C-L0172F-00
 LED 120leds/m 3000°K 14,4W/m 1200lm/m

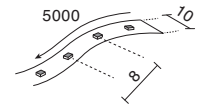

* **464D-L0115F-00**
 LED 120leds/m 3000°K 14,4W/m 1200lm/m

Alimentadores / Power supplies / Alimentateurs / Alimentadores

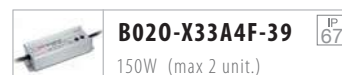

(Pag. 269)



Auto-adhs. 3M

* Longitud de tira led personalizada. Corte en tramos de 5 o 10 cm. Se suministra con 1 toma de alimentación.
 Bespoke length. Cut in sections of 5 or 10 cm. Comes with 1 power supply.
 Longueur de ruban Led sur-mesure. Coupe en sections de 5 ou 10 cm. Fourni avec un câble d'alimentation.
 Comprimento da fita de Led personalizada. Corte por seção de 5 ou 10 cm. Fornece-se com uma tomada de alimentação.

Led strip in **R G B**



464A-L0472F-00

LED 60leds/m 14,4W/m 470lm/m



464B-L0415F-00

LED 60leds/m 14,4W/m 470lm/m

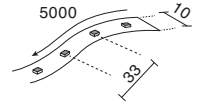

Alimentador / Power supply / Alimentateur / Alimentador



B020-X3380F-39

80W (max. 1 unit.)



B020-X33A4F-39

150W (max. 2 unit.)

(Pag. 269)

Sistema control RGB / RGB control system

Système de contrôle RGB / Sistema de controle RGB



B05F-G33A9F-39

432W (max. 2 unit.)



30m.

Amplificador / Amplifier / Amplificateur / Amplificador



B05H-G33A7F-39

216W (max. 2 unit.)



Precisa transformador adicional
Additional transformer required
Nécessite transformateur supplémentaire
Requer transformador adicional



Auto-adhs. 3M

* Longitud de tira led personalizada. Corte en tramos de 10 cm. Se suministra con 1 toma de alimentación.
Bespoke length. Cut in sections of 10 cm. Comes with 1 power supply.
Longueur de ruban Led sur-mesure. Coupe en sections de 10 cm. Fourni avec un câble d'alimentation.
Cumprimento da fita de Led personalizada. Corte por seção de 10 cm. Fornece-se com uma tomada de alimentação.

Led strip out

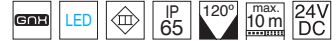

Resina de Poliuretano / Polyurethane resin
Résine de Polyuréthane / Resina de Poliuretano



465F-L0124F-29 3000°K
465F-L0224F-29 4000°K
LED 60leds/m 4,8W/m 310lm/m

* **465G-L0105F-29** 3000°K
465G-L0205F-29 4000°K
LED 60leds/m 4,8W/m 310lm/m

Alimentador / Power supply / Alimentateur / Alimentador

B020-X3340F-39
40W (max. 1 unit.)
B020-X3380F-39
80W (max. 3 unit.)

(Pag. 269)

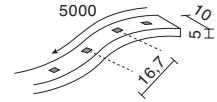

465D-L0172F-29
LED 60leds/m 3000°K 14,4W/m 630lm/m

* **465E-L0115F-29**
LED 60leds/m 3000°K 14,4W/m 630lm/m

Alimentador / Power supply / Alimentateur / Alimentador

B020-X3380F-39
80W (max. 1 unit.)
B020-X33A4F-39
150W (max. 2 unit.)

(Pag. 269)

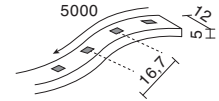

465B-L0172F-29
LED 120leds/m 3200°K 14,4W/m 1120lm/m

* **465C-L0115F-29**
LED 120leds/m 3200°K 14,4W/m 1120lm/m

Alimentador / Power supply / Alimentateur / Alimentador

B020-X3380F-39
80W (max. 1 unit.)
B020-X33A4F-39
150W (max. 2 unit.)

(Pag. 269)

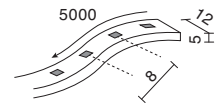

Auto-adhs. 3M

* Longitud de tira led personalizada. Corte en tramos de 5 o 10 cm. Se suministra con 1 toma de alimentación.
Bespoke length. Cut in sections of 5 or 10 cm. Comes with 1 power supply.

Longueur de ruban Led sur-mesure. Coupe en sections de 5 ou 10 cm. Fourni avec un câble d'alimentation.

Cumprimento da fita de Led personalizada. Corte por seção de 5 ou 10 cm. Fornece-se com uma tomada de alimentação.

Led strip out

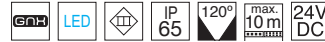

Protector de silicona / Silicon protector
 Protecteur de silicone / Protetor de silicone



465A-L0124F-29

LED 60leds/m 3000K 4,8W/m 240lm/m

Alimentador / Power supply / Alimentateur / Alimentador

	B020-X3340F-39 40W (max. 1 unit.)
	B020-X33A1F-39 100W (max. 2 unit.)

(Pag. 269)

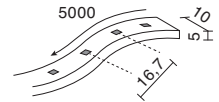

RGB



465F-L0472F-29

LED 120leds/m 14,4W/m 500lm/m



465G-L0415F-29

LED 120leds/m 14,4W/m 500lm/m

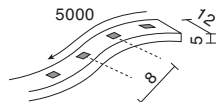

Alimentador / Power supply / Alimentateur / Alimentador



	B020-X3380F-39 80W (max. 1 unit.)
	B020-X33A4F-39 150W (max. 2 unit.)

(Pag. 269)

Sistema control RGB / RGB control system
 Système de contrôle RGB / Sistema de controle RGB

	B05E-G33A7F-39 288W (max. 2 unit.)					
	30m.					

Amplificador / Amplifier / Amplificateur / Amplificador

	B05G-G33A8F-39 216W (max. 2 unit.)				<small>Precisa transformador adicional Additional transformer required Nécessite transformateur supplémentaire Requer transformador adicional</small>
---	--	---	---	---	---



Auto-adhs. 3M

* Longitud de tira led personalizada. Corte en tramos de 5 o 10 cm. Se suministra con 1 toma de alimentación.
 Bespoke length. Cut in sections of 5 or 10 cm. Comes with 1 power supply.
 Longueur de ruban Led sur-mesure. Coupe en sections de 5 ou 10 cm. Fourni avec un câble d'alimentation.
 Comprimento da fita de Led personalizada. Corte por seção de 5 ou 10 cm. Fornece-se com uma tomada de alimentação.

Dispositivos RGB / RGB devices / Dispositifs RGB / Dispositivos RGB



Driver
Push
Driver
Driver



B02X-X33J2F-00 3x 16,8W



Panel controlador DMX táctil de pared, 1 zona RGB
DMX touch panel controller, 1 RGB zone
Écran tactile générateur DMX, 1 zone RGB
Painel controlador DMX táctil de parede, 1 zona RGB



B05L-X33X2E-00 12x85x25mm



Decodificador DMX RGB
RGB DMX decoder
Décodeur DMX RGB
Descodificador DMX RGB



B05I-X33J3F-00 4x 120W



Panel controlador DMX táctil de pared, 4 zonas RGBW
DMX touch panel controller, 4 RGBW zone.
Écran tactile générateur DMX., 4 zone RGBW
Painel controlador DMX táctil de parede, 4 zonas RGB



B05M-X33X2F-00 80x86x29,10mm

Empotramiento en cajetín universal NO INCLUIDO
Recessing by flush mounting box NOT INCLUDED
Encastrement en boîtier universel NON INCLUS
Encastramento em caixa universal NÃO INCLUÍDA



* Fuente alimentación / Power Supply / Source d'alimentation / Fonte de alimentação

Skoll

Dispositivos RGB / RGB devices / Dispositifs RGB / Dispositivos RGB



Receptor RF RGB
RGB RF receiver
Récepteur RF RGB
Receptor RF RGB



B05J-X33J4F-00 3x 120W



Mando RF controlador, 4 zonas RGB.
RF remote controller of 4 RGB zones.
Télécommande RF, 4 zone RGB.
Comando RF controlador, 4 zonas RGB.



B05N-X33X2X-00



★ Fuente alimentación / Power Supply / Source d'alimentation / Fonte de alimentação.



Amplificador de señal RGB
RGB power repeater
Amplificateur de signal RGB
Amplificador de sinal RGB



B05K-X33J4F-00 3x 120W

Skoll

Perfil / Profil / Profilé / Perfis

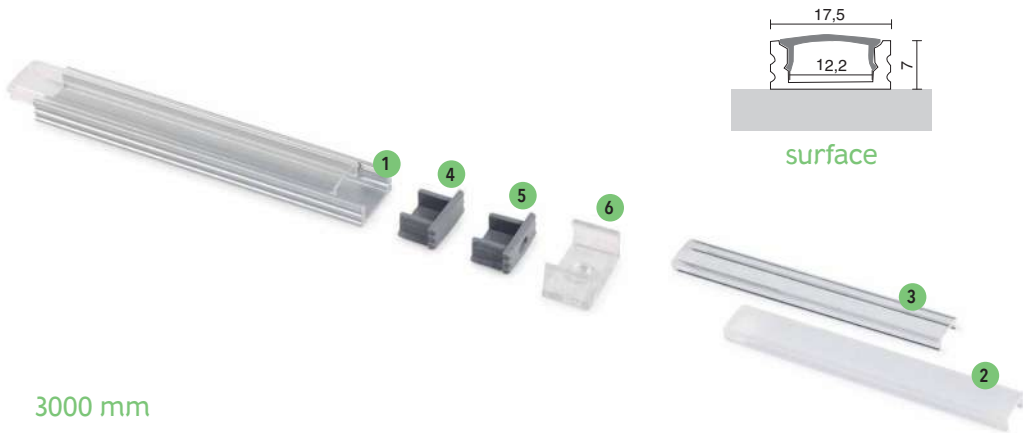

3000 mm

Ref.

ALU

1 **A50A-778-39**

Perfil aluminio anodizado en "U" 7x17,5 mm adosado (3m)
7x17,5mm "U" -shaped surface anodized aluminium profile (3m)
Profil en aluminium anodisé dans "U" 7x17,5 mm sur surface (3m)
Perfil alumínio anodizado em "U" 7x17,5 mm de superfície (3m)

PC
OPAL

2 **A50C-778-00**

Difusor PC opal (3m)
Opal PC diffuser (3m)
Diffuseur PC opale (3m)
Difusor PC opalino (3m)

PC
TRANS

3 **A50D-778-00**

Difusor PC transparente (3m)
Clear PC diffuser (3m)
Diffuseur PC transparent (3m)
Difusor PC transparente (3m)

4 **A50G-778-03**

Tapa final gris sin agujero
Grey end cap w/o hole
Embout sans trou en gris
Tampa final cinzenta sem furo

5 **A50H-778-03**

Tapa final gris con agujero
Grey end cap with hole
Embout avec trou en gris
Tampa final cinzenta com furo

6 **A50I-778-00**

Fijación transparente
Clear clamp
Fixation transparente
Fixação transparente

kit 1000 mm

Ref.

ALU

A50B-778-39

Perfil aluminio anodizado en "U" 7x17,5 mm adosado (1m)+ tapas+fijaciones
7x17,5mm "U" -shaped surface anodized aluminium profile (1m)+end caps+clamps
Profil en aluminium anodisé dans "U" 7x17,5 mm sur surface (1m)+embouts+fixations
Perfil alumínio anodizado em "U" 7x17,5 mm de superfície (1m) + tampas + fixações

ALU + PC
OPAL

A50E-778-39

Perfil aluminio anodizado en "U" 7x17,5 mm adosado (1 m)+difusor PC opal+ tapas+fijaciones
7x17,5mm "U" -shaped surface anodized aluminium profile (1m)+ opal PC diffuser+end caps+clamps
Profil en aluminium anodisé dans "U" 7x17,5 mm sur surface (1m)+diffuseur PC opale + embouts+fixations
Perfil alumínio anodizado em "U" 7x17,5 mm de superfície (1m) + difusor PC opal + tampas + fixações

ALU + PC
TRANS

A50F-778-39

Perfil aluminio anodizado en "U" 7x17,5 mm adosado (1m)+difusor PC transparente+ tapas+fijaciones
7x17,5mm "U" -shaped surface anodized aluminium profile (1m)+clear PC diffuser+end caps+clamps
Profil en aluminium anodisé dans "U" 7x17,5 mm sur surface (1m)+diffuseur PC transparent + embouts+fixations
Perfil alumínio anodizado em "U" 7x17,5 mm de superfície (1m) + difusor de PC transparente + tampas + fixações

Skoll

Perfil / Profil / Profilé / Perfis

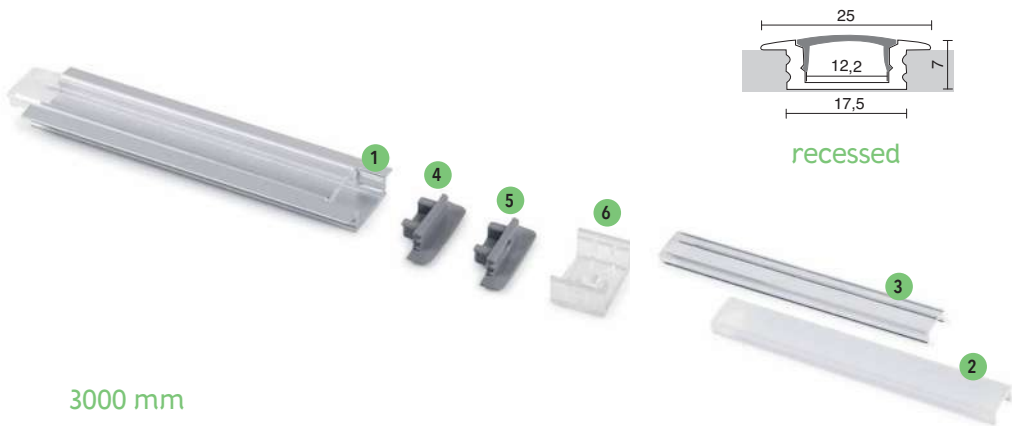

3000 mm

Ref.

	1 A51A-778-39	Perfil aluminio anodizado empotrado 7x25 mm (3m) 7x25 mm recessed anodized aluminium profile (3m) Profil en aluminium anodisé encastré 7x25 mm (3m) Perfil alumínio anodizado de encastrar 7x25 mm (3m)
	2 A51C-778-00	Difusor PC opal (3m) Opal PC diffuser (3m) Diffuseur PC opale (3m) Difusor PC opalino (3m)
	3 A51D-778-00	Difusor PC transparente (3m) Clear PC diffuser (3m) Diffuseur PC transparent (3m) Difusor de PC transparente (3m)
	4 A51G-778-03	Tapa final gris sin agujero Grey end cap w/o hole Embout sans trou en gris Tampa final cinza sem furo
	5 A51H-778-03	Tapa final gris con agujero Grey end cap with hole Embout avec trou en gris Tampa final cinza com furo
	6 A51I-778-00	Fijación transparente Clear clamp Fixation transparente Fixação transparente

kit 1000 mm

Ref.

	A51B-778-39	Perfil aluminio anodizado empotrado 7x25 mm (1m)+ tapas+fijaciones 7x25 mm recessed anodized aluminium profile (1m)+end caps+clamps Profil en aluminium anodisé encastré 7x25 mm (1m)+embouts+fixations Perfil alumínio anodizado de encastrar 7x25 mm (1m) + tapas + fixações
+	A51E-778-39	Perfil aluminio anodizado empotrado 7x25 mm (1m)+difusor PC opal+ tapas+fijaciones 7x25 mm recessed anodized aluminium profile (1m)+opal PC diffuser+end caps+clamps Profil en aluminium anodisé encastré 7x25 mm (1m)+diffuseur PC opale +embouts+fixations Perfil alumínio anodizado de encastrar 7x25 mm (1m) + difusor PC opal + tapas + fixações
+	A51F-778-39	Perfil aluminio anodizado empotrado 7x25 mm (1m)+difusor PC transparente+ tapas+fijaciones 7x25 mm recessed anodized aluminium profile (1m)+clear PC diffuser+end caps+clamps Profil en aluminium anodisé encastré 7x25 mm (1m)+diffuseur PC transparent +embouts+fixations Perfil alumínio anodizado de encastrar 7x25 mm (1m) + difusor de PC transparente + tapas + fixações

Skoll

Perfil / Profil / Profilé / Perfis

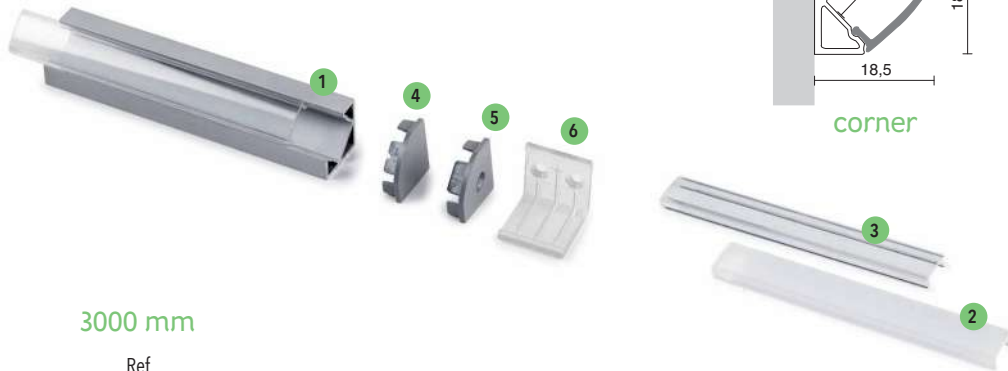

3000 mm

Ref.

ALU	1 A52A-778-39	Perfil aluminio anodizado esquinero 18,5x18,5 mm (3m) 18,5x18,5 mm anodized aluminium corner profile (3m) Profil en aluminium anodisé pour coin 18,5x18,5mm (3m) Perfil aluminio anodizado de canto 18,5x18,5mm (3m)
PC OPAL	2 A52C-778-00	Difusor PC opal (3m) Opal PC diffuser (3m) Diffuseur PC opale (3m) Difusor PC opalino (3m)
PC TRANS	3 A52D-778-00	Difusor PC transparente (3m) Clear PC diffuser (3m) Diffuseur PC transparent (3m) Difusor PC Transparente (3m)
	4 A52G-778-03	Tapa final gris sin agujero Grey end cap w/o hole Embout sans trou en gris Tampa final cinzenta sem furo
	5 A52H-778-03	Tapa final gris con agujero Grey end cap with hole Embout avec trou en gris Tampa final cinzenta com furo
	6 A52I-778-00	Fijación transparente Clear clamp Fixation transparente Fixação transparente

kit 1000 mm

Ref.

ALU	A52B-778-39	Perfil aluminio anodizado esquinero 18,5x18,5 mm (1m)+ tapas+fijaciones 18,5x18,5 mm anodized aluminium corner profile (1m)+end caps+clamps Profil en aluminium anodisé pour coin 18,5x18,5 mm(1m)+embouts+fixations Perfil aluminio anodizado de canto 18,5x18,5mm (1m)+tampas+fixações
ALU + PC OPAL	A52E-778-39	Perfil aluminio anodizado esquinero 18,5x18,5 mm (1m)+difusor PC opal+ tapas+fijaciones 18,5x18,5 mm anodized aluminium corner profile (1m)+opal PC diffuser+end caps+clamps Profil en aluminium anodisé pour coin 18,5x18,5 mm (1m)+diffuseur PC opale +embouts+fixations Perfil aluminio anodizado de canto 18,5x18,5mm (1m)+Difusor PC opalino (1m)+tampas+fixações
ALU + PC TRANS	A52F-778-39	Perfil aluminio anodizado esquinero 18,5x18,5 mm (1m)+difusor PC transparente+ tapas+fijaciones 18,5x18,5 mm anodized aluminium corner profile (1m)+clear PC diffuser+end caps+clamps Profil en aluminium anodisé pour coin 18,5x18,5 mm (1m)+diffuseur PC transparent +embouts+fixations Perfil aluminio anodizado de canto 18,5x18,5mm (1m)+Difusor PC transparente (1m)+tampas+fixações

Led T2



378A-L3103A-01 3000K

378A-L3103A-02 4000K

GX53 LED T2 3W 350lm

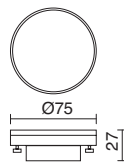

378A-L3104A-01 15 €

GX53 LED T2 4W 300lm 3000K

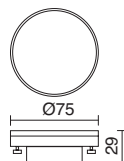

378A-L3106A-01 3000K

378A-L3106A-02 4000K

GX53 LED T2 6W 500lm

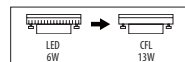
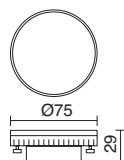

378B-L3107A-01 3000K

378B-L3107A-02 4000K

GX53 LED T2 7W 700lm

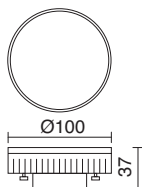

378B-L3110A-01 3000K

378B-L3110A-02 4000K

GX53 LED T2 10W 1000lm

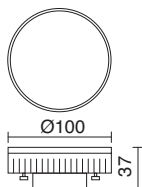

378C-L3111A-01 3000K

378C-L3111A-02 4000K

GX53 LED T2 11W 900lm

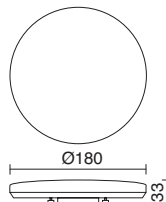

Led filament



632C-L0504B-01

E27 LED 4W 470lm 3000K

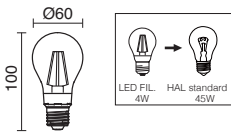

632C-L0506B-01

E27 LED 6W 800lm 2700K

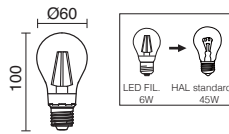

632C-L0507B-01

E27 LED 6,6W 720lm 3000K

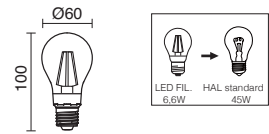

632F-L0504B-01

E27 LED 4W 470lm 3000K

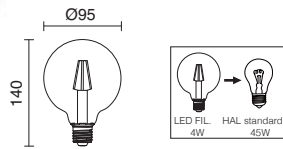

632G-L0504B-01

E27 LED 4W 470lm 3000K

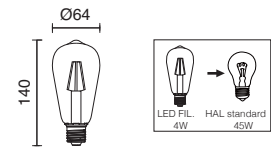

632D-L0404B-01

E14 LED 4W 470lm 3000K

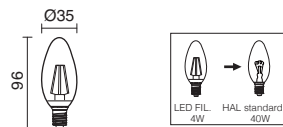

632E-L0404B-01

E14 LED 4W 470lm 3000K

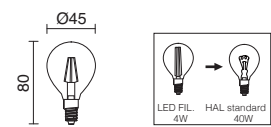

Led pro



578A-L2104A-01 3000K
578A-L2104A-02 4000K

GU10 LED 3,5W 400lm

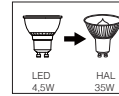
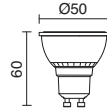

578A-L2105A-01 3000K
578A-L2105A-02 4000K

GU10 LED 4,5W 300lm



369C-L2308D-01 3000K
369C-L2308D-02 4000K

GU5,3 LED 7,6W 550lm

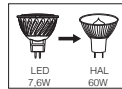
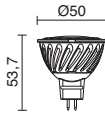

368C-L2305D-01 3000K
 GU5,3 LED 4W 300lm

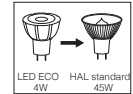

G9



369D-L2003B-01

G9 LED 2,5W 160lm 3000K



369D-L2003B-02

G9 LED 2,5W 160lm 4000K

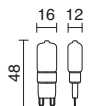

Inel



609A-L0109A-03

LED 8,5W 700lm 3000K

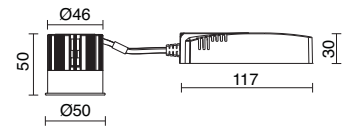

Led modul



371A-L3309B-01

LED SMD 8,7W 780lm 2900-3200K

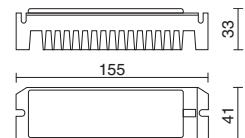
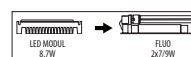

Gia

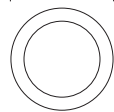
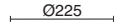
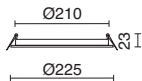
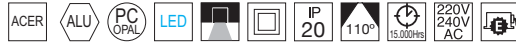

599A-L0118B-01 □

LED 18W 1250lm 3000K

599A-L0124B-01 □

LED 24W 1700lm 3000K

599A-L0218B-01 □

LED 18W 1310lm 4000K

599A-L0224B-01 □

LED 24W 1700lm 4000K

599A-L0318B-01 □

LED 18W 1310lm 6000K

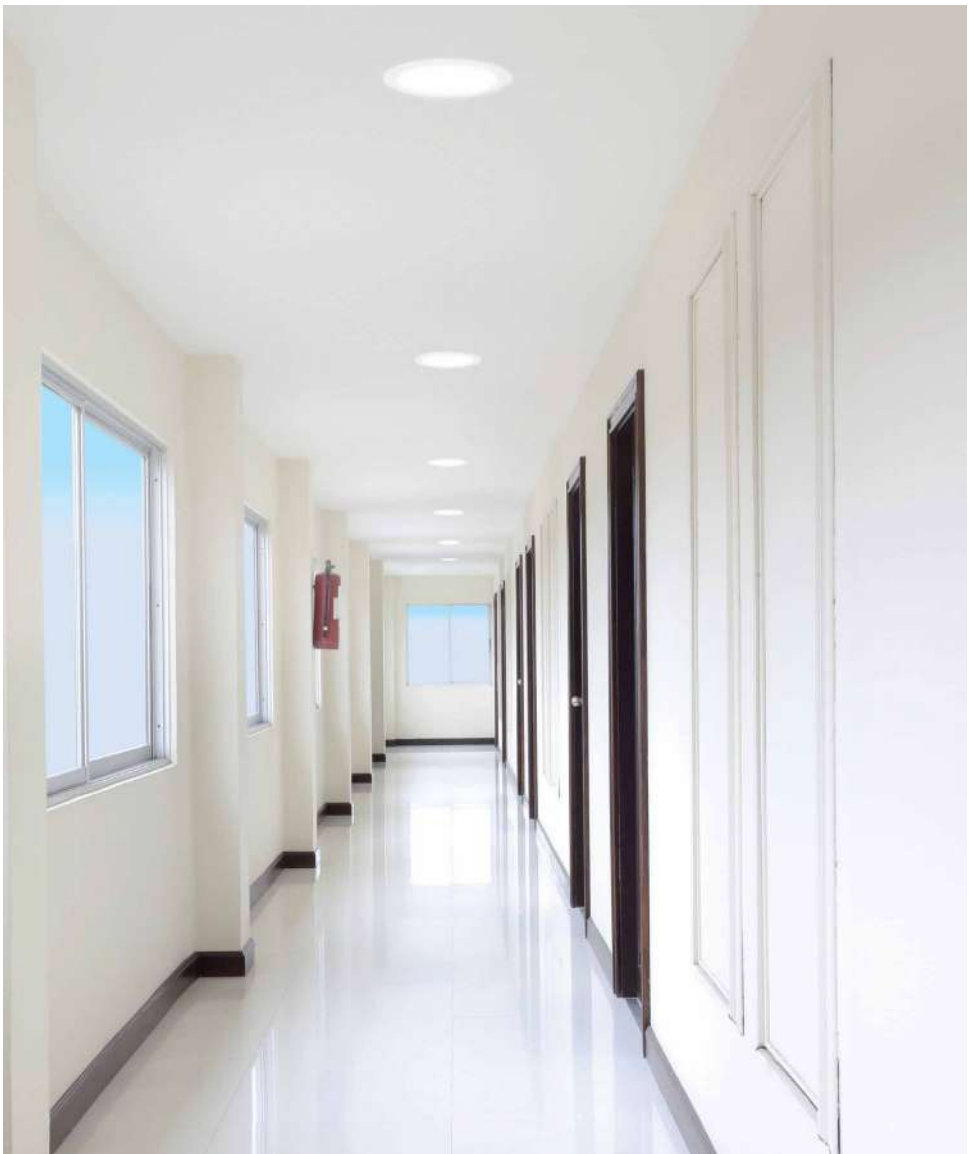



583A-LO140B-01

LED 40W 3250lm 3000K

583A-LO240B-01

LED 40W 3600lm 4000K

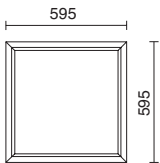

- Para falso techo modular.
- For modular ceiling.
- Pour faux plafond.
- Instalação em gesso cartonado.

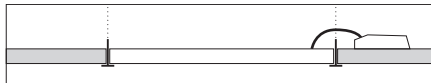

Accesorio superficie / Surface accessory
Accessoire surface / Acessório de superfície

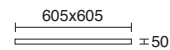

A20B-583-01

583B-LO140B-01

LED 40W 3250lm 3000K

583B-LO240B-01

LED 40W 3600lm 4000K

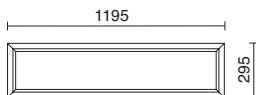
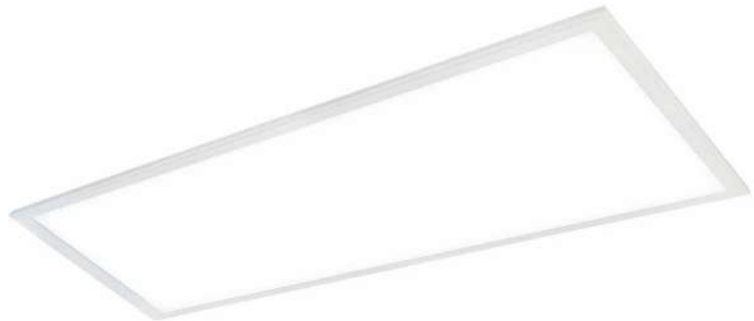

Kit de suspensión / Suspension kit
Kit de suspension / Kit de suspensão

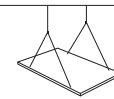

A20B-583-38

H max. 140cm







Track

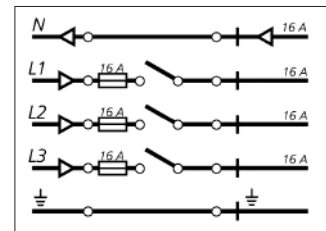
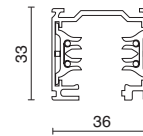

B 10A-X33X2A-01	□	100 cm
B 10A-X33X2A-02	■	100 cm
B 10A-X33X2A-03	■	100 cm
B 10B-X33X2A-01	□	200 cm
B 10B-X33X2A-02	■	200 cm
B 10B-X33X2A-03	■	200 cm
B 10C-X33X2A-01	□	300 cm
B 10C-X33X2A-02	■	300 cm
B 10C-X33X2A-03	■	300 cm
B 10D-X33X2A-01	□	400 cm
B 10D-X33X2A-02	■	400 cm
B 10D-X33X2A-03	■	400 cm

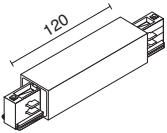
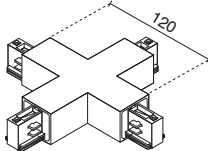
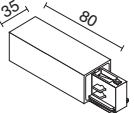
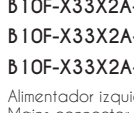
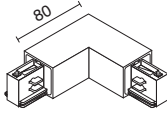
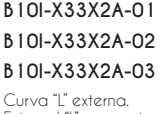
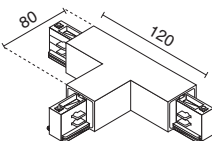
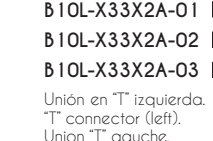
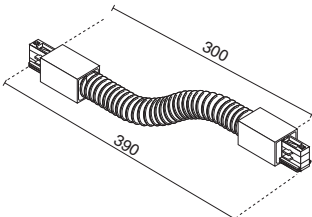
Carril / Track / Rail / Calha

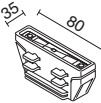
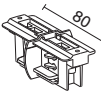
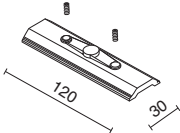

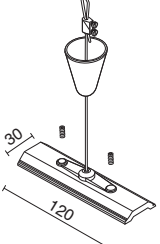
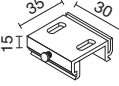
 <p> B10G-X33X2A-01 <input type="checkbox"/> B10G-X33X2A-02 <input checked="" type="checkbox"/> B10G-X33X2A-03 <input type="checkbox"/> Alimentador central. Central power supply. Alimentation centrale. Alimentador central. </p>	 <p> B10J-X33X2A-01 <input type="checkbox"/> B10J-X33X2A-02 <input checked="" type="checkbox"/> B10J-X33X2A-03 <input type="checkbox"/> Unión en "X". "X" connector. Union "X". Junção "X". </p>
 <p> B10E-X33X2A-01 <input type="checkbox"/> B10E-X33X2A-02 <input checked="" type="checkbox"/> B10E-X33X2A-03 <input type="checkbox"/> Alimentador derecha. Mains connector (right). Alimentation droite. Alimentador direito. </p>	 <p> B10F-X33X2A-01 <input type="checkbox"/> B10F-X33X2A-02 <input checked="" type="checkbox"/> B10F-X33X2A-03 <input type="checkbox"/> Alimentador izquierda. Mains connector (left). Alimentation gauche. Alimentador esquerda. </p>
 <p> B10H-X33X2A-01 <input type="checkbox"/> B10H-X33X2A-02 <input checked="" type="checkbox"/> B10H-X33X2A-03 <input type="checkbox"/> Curva "L" interna. Internal "L" connector. Curve "L" interne. Curva "L" interior. </p>	 <p> B10I-X33X2A-01 <input type="checkbox"/> B10I-X33X2A-02 <input checked="" type="checkbox"/> B10I-X33X2A-03 <input type="checkbox"/> Curva "L" externa. External "L" connector. Curve "L" externe. Curva "L" exterior. </p>
 <p> B10K-X33X2A-01 <input type="checkbox"/> B10K-X33X2A-02 <input checked="" type="checkbox"/> B10K-X33X2A-03 <input type="checkbox"/> Unión en "T" derecha. "T" connector (right). Union "T" droit. Junção "T" direito. </p>	 <p> B10L-X33X2A-01 <input type="checkbox"/> B10L-X33X2A-02 <input checked="" type="checkbox"/> B10L-X33X2A-03 <input type="checkbox"/> Unión en "T" izquierda. "T" connector (left). Union "T" gauche. Junção "T" esquerda esquerda. </p>
 <p> B10N-X33X2A-01 <input type="checkbox"/> B10N-X33X2A-02 <input checked="" type="checkbox"/> B10N-X33X2A-03 <input type="checkbox"/> Unión flexible. Flexible coupling. Union flexible. Junção flexível. </p>	 <p> A17E-322-01 <input type="checkbox"/> A17E-322-02 <input checked="" type="checkbox"/> A17E-322-03 <input type="checkbox"/> Tapa cierre. End cap. Fermeture couvercle. Topo encerramento. </p>
 <p> B10O-X33X2A-01 <input type="checkbox"/> B10O-X33X2A-02 <input checked="" type="checkbox"/> Unión con contacto. Connection with contact. Union avec contact. Junção com contato. </p>	 <p> A17C-322-01 <input type="checkbox"/> A17C-322-02 <input checked="" type="checkbox"/> Unión sin contacto. Connection without contact. Union sans contact. Junção sem contato. </p>
 <p> A17A-322-03 <input checked="" type="checkbox"/> Junta railes. Mains supply. Assemblage de rails. Junta de calhas trifásicas. </p>	 <p> B10P-X33X2A-01 <input type="checkbox"/> B10P-X33X2A-02 <input checked="" type="checkbox"/> B10P-X33X2A-03 <input type="checkbox"/> Adaptador carril electromecánico 6A (10Kg) Electro/mechanical adapter 6A (10Kg) Adaptateur rail électromécanique 6A (10Kg) Adaptador electromecánico 6A (10Kg) </p>
 <p> A17D-322-01 <input type="checkbox"/> A17D-322-02 <input checked="" type="checkbox"/> Kit de suspensión 2 m. Suspension with mains supply 2m. Kit suspension 2m. Kit suspensão 2m. </p>	 <p> A17B-322-01 <input type="checkbox"/> Fijación a techo. Ceiling connection. Montage sur plafond. Fixação ao tecto. </p>

Alimentadores / Power supplies / Alimentateurs / Alimentadores

**12V
AC**

	REF.	OUT				IN		SIZES	IP
		V	C	220-240V	110-127V	V	Freq.		
	B02A-X3317H-01	-	350 mA DC	0-17W	0-12W	110-240 V AC	50/60 Hz	120x40x20	20
	B02A-X3320I-01	-	500 mA DC	0-20W	0-12W	110-240 V AC	50/60 Hz	120x40x20	20
	B02G-X3306J-01	-	700 mA DC	6W	-	100-240 V AC	50/60 Hz	58x40x20	20
	B02A-X3317J-01	-	700 mA DC	0-17W	0-12W	110-240 V AC	50/60 Hz	120x40x20	20
	B02N-X3320M-01	-	1050 mA DC	20W	-	220-240 V AC	50/60 Hz	32x28x112	20
	B02J-X3350D-02	12 V AC	-	50W	-	220-240 V AC	50/60 Hz	80x78x60	65
	B02S-X3360E-32	12 V DC	-	60W	-	230 V AC	50/60 Hz	310x130x46	20
	B02B-X3360B-01	12 V AC	-	60W	-	220-240 V AC	50/60 Hz	22x36x103	20
	B02B-X33A2B-01	12 V AC	-	105W	-	230-240 V AC	50/60 Hz	33x37x128	20
	B02B-X33A4B-01	12 V AC	-	150W	-	230-240 V AC	50/60 Hz	33x37x185	20
	B02M-X33A5D-03	12 V AC	-	200W	-	230 V AC	50/60 Hz	108x104x99	20
	B02C-X33A7D-02	12 V AC	-	300W	-	230 V AC	50 Hz	120x140	66
	B02I-X33F9D-02	12 V AC	-	350W	-	220-240 V AC	50/60 Hz	175x155x110	65
	B02F-X33A8D-32	12 V AC	-	400W	-	230 V AC	50 Hz	220x110	20
	B02M-X33A9D-03	12 V AC	-	500W	-	230 V AC	50/60 Hz	120x132x108	20
	B02I-X33G1D-02	12 V AC	-	700W	-	220-240 V AC	50/60 Hz	175x175x110	65

Alimentadores / Power supplies / Alimentateurs / Alimentadores

24V
DC

	REF.	OUT				IN		SIZES	IP
		V	C	(230 V)	(110 V)	V	Freq.		
	B02A-X332F-01	24 V DC	-	10W	6W	110-240 V AC	50/60 Hz	120x40x20	20
	B02Q-X3312F-01	24 V DC	-	12W	12W	90-295 V AC	50/60 Hz	77x40x29	30
	B02Q-X3325F-01	24 V DC	-	25W	25W	90-295 V AC	50/60 Hz	84x57x29	30
	B02V-X3335F-00	24 V DC	-	35W	35W	220-240 V AC	50/60 Hz	220x40x21	20
	B02O-X3340F-39	24 V DC	-	40W	40W	90-305 V AC	50/60 Hz	171x61x37	65
	B02V-X3360F-00	24 V DC	-	60W	60W	220-240 V AC	50/60 Hz	250x40x21	20
	B02W-X3360F-00	24 V DC	-	60W	60W	220-240 V AC	50/60 Hz	206x51x36	20
	B02Y-X3360F-00	24 V DC	-	60W	60W	220-240 V AC	50/60 Hz	180x49x32	67
	B02O-X3380F-39	24 V DC	-	80W	80W	90-305 V AC	50/60 Hz	196x51x39	65
	B02V-X3396F-00	24 V DC	-	96W	96W	220-240 V AC	50/60 Hz	300x44x23	20
	B02R-X33A1F-01	24 V DC	-	100W	100W	90-295 V AC	50/60 Hz	190x52x37	30
	B02O-X33A1F-39	24 V DC	-	100W	100W	90-305 V AC	50/60 Hz	220x68x39	65
	B02Y-X33A1F-00	24 V DC	-	100W	100W	220-240 V AC	50/60 Hz	206x68,6x37	67
	B02V-X33A4F-00	24 V DC	-	150W	150W	220-240 V AC	50/60 Hz	270x63x40,5	20
	B02O-X33A4F-39	24 V DC	-	150W	150W	90-295 V AC	50/60 Hz	220x68x39	67
	B02Y-X33A4F-00	24 V DC	-	150W	150W	220-240 V AC	50/60 Hz	206x68,6x37	67

Acabados y Pictografía

Finishes and simbology
Finitions et pictographie
Acabamentos e pictografia



Proyectos especiales para pantallas

En Grupo Novolux queremos darle el mejor servicio, por ello le ofrecemos la posibilidad de que las luminarias que Ud elija puedan vestirse con las pantallas que mejor le sienten a su proyecto, a ese espacio diseñado en armonía de formas y colores.

Le ofrecemos diferentes colores y texturas para imprimir la personalidad e imagen que usted desee proyectar.

LLámenos y consulte disponibilidad, bajo pedido podemos poner a su disposición muchas combinaciones.

Special projects for shades

The aim of Grupo Novolux is to provide you the best possible service, so we offer you the possibility to choose the shades for the lighting fixtures to better suit your project and to achieve a space designed in harmony of shapes and colors.

We propose different colors and textures to print the personality and image you want to project.

Contact us and check availability, upon request we can put at your disposal different combinations.

Solutions spéciales pour vos abat-jours

Toujours soucieux de vous offrir le meilleur service, grupo novolux vous propose une large sélection d'abat-jours pour habiller les luminaires que vous sélectionnez et les intégrer dans votre projet, dans cet espace que vous avez créé en harmonie en harmonie de formes et de couleurs.

Un grand choix de coloris et textures vous est proposé pour refléter la personnalité et l'image que vous souhaitez transmettre.

N'hésitez pas à nous solliciter pour consulter les disponibilités. Une large gamme de solutions est disponible sur commande.

Projotos especiais para abajures

No Grupo Novolux queremos dar-lhe o melhor serviço, por isso oferecemos-lhe a possibilidade de que as luminarias que você escolha possam equipar-se com os Abajures que melhor fiquem no seu projeto, para que esse espaço esteja desenhado, concebido, em harmonia de formas e cores.

Oferecemos-lhe diferentes cores e texturas para imprimir a personalidade e imagem que você deseja projetar.

Contate-nos e consulte a disponibilidade, sob pedido podemos pôr à sua disposição muitas combinações.



▲
Acabados de pantalla bajo pedido
Shade finishes supplied under request
Finitions d'abat-jours sur demande
Acabamentos na tela bajo pedido

Cotton

CA White

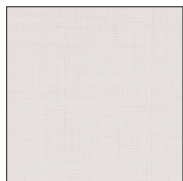

CB Black



CC Beige



CD Moutarde



CE Capuccino



CG Earth



CH Orange



CJ Red



CK Grey



CM Brown



Linen

BA White



BD Stone



BE Graphite



BF Brown



Eco

DC Beige



Yute

HC Beige



Persia

FC Beige



Damasco

GD Brown



Acabados / Finishes / Finitions / Acabamentos

Los artículos de este catálogo se suministran según el modelo, con diferentes acabados. Estos vienen representados por las dos últimas cifras del código y un recuadro de color. El color en las fotografías de producto, es orientativo debido a las variaciones de las tonalidades que ocasiona el proceso de impresión.

The articles in this catalogue are supplied according to the model, with different finishes. These are represented by icons. Colours in the product photographs are purely orientative as variations in shades may be produced in the printing process.

Les produits de ce catalogue sont fournis d'après le modèle, avec des finitions différentes. Ceux-ci sont représentés par des icônes différentes. La couleur dans les images du produit est seulement indicative à cause des variations des teintes dues par le processus d'impression.

Os artigos deste catálogo são fornecidos segundo o modelo, com diferentes acabamentos. Estes são representados por diferentes ícones. A cor do produto nas fotografias é meramente indicativa devido às variações das tonalidades provocadas pelo processo de impressão.

01	Blanco / White / Blanc / Branco	34	Latón / Brass / Laiton / Latão	55	Fibra sintética plata Synthetic silver fiber Fibre synthétique argent Fibra Sintética Prata
02	Negro / Black / Noir / Preto	35	Níquel satinado / Satin nickel Nickel satiné / Níquel acetinado	56	Fibra sintética oro Synthetic gold fiber Fibre synthétique or Fibra Sintética Ouro
03	Gris / Grey / Gris / Cinzento	36	Latón cromo / Chrome brass Laiton chrom / Latão cromo	60	Piedra Leccese / Leccese stone Pierre Leccese / Pedra Leccese
04	Antracita / Anthracite Anthracite / Antracite	37	Cobre / Copper / Cuivre / Cobre	61	Piedra Leccese Antracita Leccese anthracite stone Pierre Leccese Anthracite Pedra Leccese
05	Verde / Green / Verd / Verde	38	Acero cincado / Zinc-plated Steel Acier zingué / Aço zincado	62	Piedra Leccese marrón / Leccese brown stone Pierre Leccese brun / Pedra Leccese brown
07	Rojo / Red / Rouge / Vermelho	39	Aluminio anodizado / Anodized aluminum Aluminium anodisé / Aluminio anodizado	63	Piedra Leccese rosso mattone Leccese rosso mattone stone Pierre Leccese rosso mattone Pedra Leccese rosso mattone
09	Beige / Beige / Beige / Bege	40	Aluminio cepillado / Brushed aluminum Aluminium brossé / Aluminio cepillado	64	Piedra Crema / Cream stone Pierre Crème / Pedra Creme
10	Gris envejecido / Antique grey Gris vieilli / Cinzento velho	41	Acero Galvanizado / Galvanized Steel Acier galvanisé / Aço galvanizado	65	Piedra Ardesia / Ardesia stone Pierre Ardesia / Pedra Ardesia
11	Marfil / Ivory / Ivoire / marfim	42	Burdões cepillado / Brushed Burgundy Bordeaux brossé / Bordeaux cepillado	71	Piedra Lavica / Lavica stone Pierre Lavica / Pedra Lavica
12	Marrón oscuro / Dark brown Marron foncé / Marrom escuro	43	Inox cepillado / Brushed stainless steel Inox brossé / Inox cepillado	74	Marmol Travertino / Travertino marble Marbre Travertino / Mármore Travertino
13	Gris piedra / Stone grey Gris pierre / Pedra cinzenta	44	Plata / Silver / Argenti / Prata	75	Marmol de Carrara / Carrara marble Marbre de Carrara / Mármore do Carrara
28	Matizado / Frosted / Mat / Fosco	46	Oro mate / Matt gold Or mat / Matt ouro	90	Marrón óxido / Oxide brown Roville / Marrom óxido
29	Transparente / Transparent Transparent / Transparente	50	Madera Haya / Beech Wood Bois hêtre / Madeira faia	91	Marrón cobrizo / Copper brown Brune cuivre / Marrom cobre
30	Inox / Stainless steel Acier inoxydable / Aço inox	51	Madera Roble / Oak Wood Bois chêne / Madeira Carvalho	92	Cristal transparente / Transparent glass Verre transparent / Vidro transparente
31	Inox pulido / Brushed stainless steel Inox poli / Inox polido	52	Madera Cerezo / Cherry Wood Bois de cerisier / Madeira Cerejeira	94	Pan de oro / Gold leaf Feuille d'or / Pão de Ouro
32	Cromo / Chrome / Chrom / Cromo	53	Fibra natural beige / Natural beige fiber Fibre naturelle beige / Fibra Natural Beige	95	Pan de plata / Silver leaf Feuille d'argent / Pão de Prata
33	Latón envejecido / Antique brass Laiton vieilli / Latão antigo	54	Fibra natural marrón Natural brown fiber Fibre naturelle marron Fibra Natural Castanho		

Materiales / Materials / Matériaux / Materiais



Cuerpo / Body / Corps / Corpo



Marco / Frame / Marc / Aro





























Difusor / Diffusor / Diffuseur / Difusor















































Aspa / Blade / Lame / Pala

ACER	Acero	Steel	Acier	Aço
ALU	Aluminio	Aluminium	Aluminium	Alumínio
ALU ANOD	Aluminio anodizado	Anodized aluminum	Aluminium anodisé	Aluminio anodizado
ALU CEPILL	Aluminio cepillado	Brushed aluminum	Aluminium brossé	Aluminio cepillado
ANTIQ BRASS	Latón envejecido	Antique brass	Laiton vieilli	Latão antigo
BRASS	Latón	Brass	Laiton	Latão
CHROM BRASS	Latón cromado	Chrome brass	Laiton chrom	Latão cromo
COTTON	Algodón	Cotton	Coton	Algodão
CONCR	Hormigón	Concrete	Béton	Concreto
Cu	Cobre	Copper	Cuivre	Cobre
NAT FIBER	Fibra natural	Natural fiber	Fibre naturelle	Fibra natural
SYNT FIBER	Fibra sintética	Synthetic fiber	Fibre synthétique	Fibra sintética
GLASS	Cristal	Glass	Verre	Vidro
GLASS AMBER	Cristal ambar	Amber glass	Verre ambre	Vidro âmbar
GLASS MAT	Cristal matizado	Frosted glass	Verre teinté	Vidro fosco
GLASS OPAL	Cristal opalizado	Opal glass	Verre opale	Vidro opalino
GLASS PRISM	Cristal prismático	Prismatic glass	Verre prismatique	Vidro prismático
GLASS TRANS	Cristal transparente	Transparent glass	Verre transparent	Vidro transparente
INOX	Acero inoxidable	Stainless steel	Acier inoxydable	Aço inoxidável
NICKEL SAT	Niquel satinado	Satin nickel	Nickel satiné	Niquel acetinado
NYLON	Nylon	Nylon	Nylon	Nylon
PA	Poliamida	Polyamide	Polyamide	Poliamida
PC	Policarbonato	Polycarbonate	Polycarbonate	Policarbonato
PC MAT	Policarbonato matizado	Frosted polycarbonate	Polycarbonate teinté	Policarbonato fosco
PC OPAL	Policarbonato opalizado	Opal polycarbonate	Polycarbonate opale	Policarbonato opalino
PC PRISM	Policarbonato prismático	Prismatic polycarbonate	Polycarbonate prismatique	Policarbonato prismático
PC TRANS	Policarbonato transparente	Transparent polycarbonate	Polycarbonate transparent	Policarbonato transparente
PE	Poliétileno	Polyethylene	Polyéthylène	Poliétileno
PLASTER	Yeso	Plaster	Plâtre	Gesso
PMMA	Metacrilato	Methacrylate	Méthacrylate	Metacrilato
PMMA MAT	Metacrilato matizado	Frosted methacrylate	Méthacrylate teinté	Metacrilato fosco
PMMA OPAL	Metacrilato opalizado	Opal methacrylate	Méthacrylate opale	Metacrilato opalino
PMMA PRISM	Metacrilato prismático	Prismatic methacrylate	Méthacrylate prismatique	Metacrilato prismático
PMMA TRANS	Metacrilato transparente	Transparent methacrylate	Méthacrylate transparent	Metacrilato transparente
PPH	Polipropileno homopolimero	Polypropylene homopolymer	Polypropylène homopolymère	Homopolimero de polipropileno
RESIN	Resina	Resin	Resine	Resina
SILICON	Silicona	Silicone	Silicone	Silicone
STONE	Piedra	Stone	Pierre	Pedra
TECNO POLIM	Tecnopolimero	Technopolymer	Technopolymère	Tecnopolimero
TERMO PLASTIC	Termoplástico	Thermoplastic	Thermoplastique	Termoplástico
WOOD	Madera	Wood	Bois	Madeira

Pictografía / Symbology / Pictografia / Pictografia

	Luminaria para superficie en pared.	Surface mounted wall luminaire.	Luminaire pour la surface du mur.	Luminária para parede, saliente.
	Luminaria para superficie en techo.	Surface mounted ceiling luminaire.	Luminaire pour la surface du plafond.	Luminária para teto, saliente.
	Luminaria para empotrar en pared.	Recessed wall luminaire.	Luminaire pour encastrer sur le mur.	Luminária para parede, encastrável.
	Luminaria para empotrar en techo.	Recessed ceiling luminaire.	Luminaire pour encastrer sur le plafond.	Luminária para teto, encastrável.
	Luminaria para empotrar en suelo.	Recessed floor luminaire.	Luminaire encastré par sol.	Luminária para pavimento, encastrável.
	Luminaria de baliza o sobremuro.	Bollard or wall-top luminaire.	Borne ou sur mur.	Luminária elemento balizador ou de muro.
	Proyector de pared.	Spotlight-type surface for wall.	Projecteur pour la surface du mur.	Projektor para parede.
	Proyector de suelo.	Spotlight-type surface for floor.	Projecteur du sol.	Projektor para pavimento.
	Luminaria con piqueta.	Luminaire with spike.	Luminaire avec piquet.	Luminária com piquet.
	Luminaria con alimentación solar.	Solar powered luminaire.	Solaire luminaria alimenté.	Luminária com alimentação solar.
	Luminaria identificadas como clásico-residencial.	Luminaire classified as classical-residential.	Luminaire identifiée comme résidentiel-classique.	Luminária do tipo clássico-residencial.
	Luminaria de suspensión.	Pendant luminaire.	Luminaire de suspension.	Luminária de Suspensão.
	Luminaria vial tipo poste o columna.	Streetlighting post or column luminaire.	Luminaire à ampoule type poteau ou colonne.	Luminária pública do tipo com poste ou coluna.
	Luminaria sumergible.	Underwater lights.	Eclairage subaquatique.	Submersíveis.
	Iluminación decorativa.	Decorative Lighting.	Éclairage décorative.	Iluminação Decorativa.
	Luminaria de pie.	Floor lamps.	Eclairage de sol.	Luminária chão.
	Luminaria de sobremesa.	Table lamps.	Luminaire de bureau.	Luminária de escritórios.
	Ventiladores.	Ceiling fans.	Ventilateurs.	Fãs.
	Gama de productos complementarios a nuestros catálogos (lámparas, tiras led, alimentadores, conectores...)	Complementary range of products on catalogs (lamps, led strips, transformers, connectors,...)	Gamme de produits en complément sur nos catalogues (lampes, rubans Led, alimentations, connecteurs...)	Gama de produtos complementares aos nossos catálogos (lâmpadas, fitas led, alimentadores, conectores...)
	Luminaria con tecnología LED.	Luminaire with LED technology.	Luminaire à technologie LED.	Luminária com tecnologia LED.
	Novedad.	New.	Nouveauté.	Novidade.
	Ampliación de gama.	Product range enlargement.	Élargissement de gamme.	Extensão de gamma.
	Producto bajo pedido.	To order product.	Produit sur demande.	Produto a pedido.
	Clase I; Luminaria provista de dispositivos de toma-tierra.	Class I; luminaire fitted with earth-ground devices.	Clase I; Luminaire fourni de dispositifs prise de terre.	Clase I; luminária com dispositivos de ligação à terra.
	Clase II; Luminaria que aísla doblemente las partes con tensión y no precisa dispositivos de toma-tierra.	Class II; luminaire that doubly insulates the electrified parts and does not require an earth-ground device.	Clase II; Luminaire qui isole doublement les parties avec tension et n'a pas besoin de dispositifs de prise de terre.	Clase II; luminária que tem duplo isolamento das partes sob tensão e não precisa de dispositivos de ligação à terra.
	Clase III; Luminaria alimentada a muy baja tensión y que no debe tener dispositivos toma-tierra.	Class III; luminaire with very low voltage power supply which does not require earth-ground devices.	Clase III; Luminaire alimentée à très basse tension et ne doit surtout pas avoir des dispositifs de prise de terre.	Clase III; luminária alimentada com muito baixa tensão e que não deve ter dispositivos de ligação à terra.

IP	<p>Grado de protección IP Según la normativa EN 60598-1, las luminarias se clasifican en función de la protección derivada de sus elementos constructivos. Su nomenclatura se simboliza mediante las letras IP seguidas de tres cifras, aunque sólo se muestren las dos primeras.</p> <p>1ª cifra: Indica la protección del material frente a la filtración de elementos extraños y polvo, así como de las personas respecto a la tensión de los componentes de la luminaria. </p> <p>0- No protegida. 1- Protegida frente a cuerpos sólidos mayores de 50 mm. 2- Protegida frente a cuerpos sólidos mayores de 12 mm. 3- Protegida frente a cuerpos sólidos mayores de 2,50 mm. 4- Protegida frente a cuerpos sólidos mayores de 1 mm. 5- Protegida contra el polvo. 6- Completa protección contra el polvo.</p> <p>2ª cifra: Indica la protección del material a la penetración de líquido. </p> <p>0- No protegida. 1- Protegida a la caída vertical de gotas de agua. 2- Protegida frente a la caída de gotas hasta un alineación de 15° respecto a la vertical. 3- Protegida frente a la lluvia. 4- Protegida contra la proyección del agua. 5- Protegida al chorro de agua. 6- Protegida a los golpes de mar. 7- Protegida a la inmersión. 8- Material sumergible.</p>	<p>Degree of IP protection In accordance with standard EN 60598-1, luminaires are classified on the basis of the protection derived from their elements of construction. The degree of protection is indicated by the letters IP followed by a 3-figure number, though only the first two numbers are shown.</p> <p>1st figure: Indicates the protection of the material against the entry of foreign bodies and dust, as well of people coming into contact with live parts in the device. </p> <p>0- Not Protected. 1- Protected against foreign objects > 50mm. 2- Protected against foreign objects > 12mm 3- Protected against foreign objects > 2.5mm. 4- Protected against foreign objects > 1mm. 5- Dust-protected 6- Completely dust-tight</p> <p>2nd figure: Indicates the protection of the material against the entry of moisture. </p> <p>0- Not protected. 1- Protected against vertically falling drops of water. 2- Protected against water drops with the housing tilted at 15° with respect to the vertical. 3- Protected against rain. 4- Protected against splashing. 5- Protected against jets of water. 6- Protected against powerful water jets. 7- Protected against temporary immersion. 8- Submersible material.</p>	<p>Indice de protection IP Conformément à la norme EN 60598-1, les luminaires sont classés en fonction de la protection dérivée de leurs éléments constructifs. Leur nomenclature est symbolisée par les lettres IP suivies de trois chiffres, même si s'affichent uniquement les deux premiers.</p> <p>1er chiffre: Indique la protection du matériel par rapport à la filtration d'éléments étrangers et de poussière, ainsi que de personnes physiques, à l'égard de la tension des composants du luminaire. </p> <p>0- Aucune protection. 1- Protégé contre les corps solides supérieurs à 50 mm. 2- Protégé contre les corps solides supérieurs à 12 mm. 3- Protégé contre les corps solides supérieurs à 2,50 mm. 4- Protégé contre les corps solides supérieurs à 1 mm. 5- Protégé contre la poussière. 6- Protection complète contre la poussière.</p> <p>2ème chiffre: Indique la protection du matériel par rapport à la pénétration de liquide. </p> <p>0- Aucune protection. 1- Protégé contre les gouttes d'eau tombant verticalement. 2- Protection contre les gouttes tombant à un alignement de 15° avec la verticale. 3- Protégé contre la pluie. 4- Protégé contre les projections d'eau. 5- Protégé contre le jet d'eau. 6- Protégé contre les coups de mer. 7- Protégé contre l'immersion. 8- Matériel submersible.</p>	<p>Grau de proteção IP Nos termos da norma EN 60598-1, as luminárias são classificadas em função da proteção derivada dos seus elementos construtivos. A sua nomenclatura é indicada pelas letras IP seguidas de três algarismos, embora só sejam mostrados os dois primeiros.</p> <p>1.º algarismo: indica a proteção do material relativamente à filtração de elementos estranhos e pó, assim como das pessoas relativamente à tensão dos componentes da luminária. </p> <p>0- Não protegida. 1- Protegida contra corpos sólidos maiores do que 50mm. 2- Protegida contra corpos sólidos maiores do que 12mm. 3- Protegida contra corpos sólidos maiores do que 2,5mm. 4- Protegida contra corpos sólidos maiores do que 1mm. 5- Protegida contra o pó. 6- Proteção completa contra o pó.</p> <p>2.º algarismo: Indica a proteção do material relativamente à penetração de líquidos. </p> <p>0- Não protegida. 1- Protegida contra a queda vertical de gotas de água. 2- Protegida contra a queda de gotas até a uma inclinação de 15° em relação à vertical. 3- Protegida contra chuva. 4- Protegida contra projeção de água. 5- Protegida contra jatos de água. 6- Protegida contra ondas do mar. 7- Protegida contra imersão. 8- Material submersível.</p>																																																																																
IK	<p>Código IK Sistema de codificación para indicar el grado de protección proporcionado por una envolvente contra los impactos mecánicos nocivos. Energía de impacto (J)</p> <table border="1" data-bbox="194 1172 435 1228"> <thead> <tr> <th>IK01</th><th>IK02</th><th>IK03</th><th>IK04</th><th>IK05</th><th>IK06</th><th>IK07</th><th>IK08</th><th>IK09</th><th>IK10</th> </tr> </thead> <tbody> <tr> <td>0,15</td><td>0,2</td><td>0,35</td><td>0,5</td><td>0,7</td><td>1</td><td>2</td><td>5</td><td>10</td><td>20</td> </tr> </tbody> </table>	IK01	IK02	IK03	IK04	IK05	IK06	IK07	IK08	IK09	IK10	0,15	0,2	0,35	0,5	0,7	1	2	5	10	20	<p>IK Code The IK code is an international numerical classification for the degree of protection provided by enclosures for electrical equipment against external mechanical impact. Impact energy (J).</p> <table border="1" data-bbox="454 1172 694 1228"> <thead> <tr> <th>IK01</th><th>IK02</th><th>IK03</th><th>IK04</th><th>IK05</th><th>IK06</th><th>IK07</th><th>IK08</th><th>IK09</th><th>IK10</th> </tr> </thead> <tbody> <tr> <td>0,15</td><td>0,2</td><td>0,35</td><td>0,5</td><td>0,7</td><td>1</td><td>2</td><td>5</td><td>10</td><td>20</td> </tr> </tbody> </table>	IK01	IK02	IK03	IK04	IK05	IK06	IK07	IK08	IK09	IK10	0,15	0,2	0,35	0,5	0,7	1	2	5	10	20	<p>Code IK Système de codification qui indique le degré de protection procuré par une enveloppante contre des impacts mécaniques nuisibles. Énergie d'impact (J)</p> <table border="1" data-bbox="713 1172 954 1228"> <thead> <tr> <th>IK01</th><th>IK02</th><th>IK03</th><th>IK04</th><th>IK05</th><th>IK06</th><th>IK07</th><th>IK08</th><th>IK09</th><th>IK10</th> </tr> </thead> <tbody> <tr> <td>0,15</td><td>0,2</td><td>0,35</td><td>0,5</td><td>0,7</td><td>1</td><td>2</td><td>5</td><td>10</td><td>20</td> </tr> </tbody> </table>	IK01	IK02	IK03	IK04	IK05	IK06	IK07	IK08	IK09	IK10	0,15	0,2	0,35	0,5	0,7	1	2	5	10	20	<p>Código IK Sistema de codificação para indicar o grau de proteção proporcionado por um invólucro contra impactos mecánicos nocivos. Energia de impacto (J).</p> <table border="1" data-bbox="972 1172 1213 1228"> <thead> <tr> <th>IK01</th><th>IK02</th><th>IK03</th><th>IK04</th><th>IK05</th><th>IK06</th><th>IK07</th><th>IK08</th><th>IK09</th><th>IK10</th> </tr> </thead> <tbody> <tr> <td>0,15</td><td>0,2</td><td>0,35</td><td>0,5</td><td>0,7</td><td>1</td><td>2</td><td>5</td><td>10</td><td>20</td> </tr> </tbody> </table>	IK01	IK02	IK03	IK04	IK05	IK06	IK07	IK08	IK09	IK10	0,15	0,2	0,35	0,5	0,7	1	2	5	10	20
IK01	IK02	IK03	IK04	IK05	IK06	IK07	IK08	IK09	IK10																																																																											
0,15	0,2	0,35	0,5	0,7	1	2	5	10	20																																																																											
IK01	IK02	IK03	IK04	IK05	IK06	IK07	IK08	IK09	IK10																																																																											
0,15	0,2	0,35	0,5	0,7	1	2	5	10	20																																																																											
IK01	IK02	IK03	IK04	IK05	IK06	IK07	IK08	IK09	IK10																																																																											
0,15	0,2	0,35	0,5	0,7	1	2	5	10	20																																																																											
IK01	IK02	IK03	IK04	IK05	IK06	IK07	IK08	IK09	IK10																																																																											
0,15	0,2	0,35	0,5	0,7	1	2	5	10	20																																																																											
	 Emisión de luz asimétrica.	Asymmetric light emission.	Émission de lumière asymétrique.	Emissão de luz assimétrica.																																																																																
	Ángulo de emisión de luz.	Light emission angle.	Angle d'émission de la lumière.	Ângulo de emissão de luz.																																																																																
	Emisión de luz directa o indirecta	Emission of direct or indirect light.	Émissions de lumière directe ou indirecte.	Emissão de luz direta ou indireta.																																																																																
	Emisión de luz directa y indirecta	Emission of direct and indirect light.	Émissions de lumière directe et indirecte.	Emissão de luz direta e indireta.																																																																																
	Multi-emisión de luz.	Multi-emission light.	Multi-émissions de lumière.	Multi-emissão de luz.																																																																																
	Emisión de luz periférica.	Periferic emission light.	Émission périphérique de lumière.	Emissão periférica de luz.																																																																																
	Longitud en metros de cable conductor suministrado.	Length in meters of the lead wire supplyd.	Longueur en mètres du câble conducteur fourni.	Comprimento em metros de cabo condutor fornecido.																																																																																

	Corriente de la luminaria en corriente continua.	Luminaire current in direct current.	Courant de la lampe avec courant continuus.	Corrente da luminária em corrente continua.
	Voltaje de la luminaria en corriente continua.	Luminaire voltage in direct current.	Tension de la lampe avec courant continuus.	Tensão da luminária em corrente continua.
	Voltaje de la luminaria (Voltios), de corriente alterna.	Luminaire voltage (volts) in alternate current.	Tension de la lampe (Volts) avec courant alternatif.	Tensão da luminária (volts) em corrente alternada.
	Luminaria con sensor crepuscular y movimiento.	Luminaire with daylight and motion sensor.	Luminaire avec senseur crépusculaire et mouvement.	Luminária con sensor crepuscular e movimento.
	Luminaria con luz de emergencia.	Luminaire with emergency light.	Luminaire avec éclairage de secours.	Luminária con luz de emergência.
	Luminaria con dos salidas de cable.	Luminaire with two cable outlets.	Luminaire avec deux sorties de câble.	Luminária com duas saídas de cabo.
	Luminaria con conexión USB (5V max. 2A)	Luminaire with USB port (5V max. 2A)	Luminaire avec connexion USB (5V max. 2A)	Luminária com ligação USB (5V max. 2A)
	Luminaria con cable clavija Incorporada.	Lighting with plug-electrical wire Included.	Luminaire avec câble d'alimentation et fiche Inclus.	Luminária com cabo e ficha Incorporada.
	Luminaria con toma corriente IP44	Luminaire with IP44 plug.	Luminaire avec prise courant électrique IP44.	Luminária con plugne IP44.
	Luminaria con interruptor Incorporado.	Lighting with switch Included.	Luminaire avec interrupteur Inclus.	Luminária com interruptor Incorporado.
	Equipo Incluido.	Luminaire with equipment Included.	Luminaire avec équipement Inclus.	Luminaire com aparelhagem Incluido.
	Equipo electrónico Incluido.	Luminaire with electronic equipment Included.	Luminaire avec équipement électronique Inclus.	Luminaire com aparelhagem electrónica Incluido.
	Equipo NO Incluido, pero sí lo necesita	Equipment not Included, but it is required.	Luminaire sans équipement mais il faut l'avoir.	Aparelhagem não Incluída, mas é necessário.
	Prueba superada con éxito de la Temperatura (xxx°) del hilo Incandescente. (°C)	Glow wire temperature test (xxx°) passed successfully (°C)	Essai au fil Incandescent (°C) passé avec succès à la température (°xxx).	Ensaio do fio Incandescente superado com éxito à temperatura (xxx°) especificada. (°C)
	Temperatura ambiental (°C) máxima y mínima para garantizar el funcionamiento de la luminaria.	Maximum and minimum temperature to guarantee proper operation of the lamps.	Températures maximales et minimales pour assurer le fonctionnement des luminaires.	Temperatura máxima e mínima para garantir o funcionamento das luminárias.
	Temperatura máxima de la superficie de la luminaria. (°C)	Maximum temperature (°C) of the glass surface at an average room temperature.	Température maximale (°C) de la surface du verre à la température ambiante.	Temperatura máxima (°C) da superfície do vidro, à temperatura ambiente.
	Ángulo máximo de basculación de la luminaria.	Maximum angle of Inclination of the lamp.	Angle maximal d'Inclinaison du luminaire.	Ângulo máximo de Inclinação da luminária.
	Ángulo máximo de giro horizontal.	Maximum angle of rotation.	Angle maximum de rotation.	Ângulo máximo de rotação.
	 Medidas de empotramiento (mm)	Recess dimensions (mm)	Mesures pour encastrément (mm)	Medidas de encastramento (mm)
	Dimerable.	Dimmable.	Dimmable.	Dimmable.
	NO dimerable.	Non dimmable.	Non dimmable.	Não dimmable.
	Luminaria con lámpara Incluida.	Luminaire with lamp Included.	Luminaire avec lampe Inclus.	Luminária com lâmpada Incluída.
	Anclaje Incluido.	Anchorage Included.	Ancrage Inclus.	Ancoragem Incluido.
	Caja de empotrar Incluida.	Recessing box Included.	Boîtier d'encastrement Inclus.	Caixa embutida Incluido.
	No utilizar en ningún caso atornilladores mecánicos.	Never use mechanical screwdrivers.	Surtout ne jamais utiliser de tournevis mécanique.	Não utilizar, em caso algum, aparafusadoras mecânicas.
	Precisa drenaje.	Requires drainage.	Drainage nécessaire.	Drenagem precisa.
	Luminaria adaptada para tránsito no rodado.	Luminaire adapted for non-vehicular traffic.	Luminaire adapté au trafic pas roulé.	Luminária adaptada para trânsito não rodoviário.
	Luminaria adaptada para tránsito rodado.	Luminaire adapted for vehicular traffic.	Luminaire adapté au trafic roulé.	Luminária adaptada para trânsito rodoviário.

	Globo con cierre bayoneta.	Globe with bayonet fitting.	Globe avec fermeture baïonnette.	Globo com fecho baioneta.
	Globo con cierre hermético.	Hermetically sealed globe.	Globe avec fermeture hermétique.	Globo com fecho hermético.
	Poste con registro.	Post with inspection chamber.	Poste avec enregistrement.	Lampost com registro.
	Luminarias con alta resistencia a los rayos Ultra Violeta para evitar que el color se deteriore.	Luminaires with high resistance to Ultra-Violet rays to prevent color deterioration.	Luminaires with high resistance to Ultra-Violet rays to prevent color deterioration.	Luminárias com elevada resistência aos raios Ultra Violetas para evitar a deterioração da cor.
	Luminaria con una excelente resistencia a la corrosión (aluminio con doble recubrimiento de pintura, acero con proceso de galvanizado, resina o poliamida)	Luminaire with excellent resistance to corrosion (aluminum with double painting process, steel galvanizing process, resin or polyamide)	Luminaire avec une excellente résistance à la corrosion (aluminium avec double processus de peinture, processus de galvanisation de l'acier, résine ou polyamide)	Luminária com excelente resistência à corrosão (alumínio com processo de pintura dupla, processo de galvanização de aço, resina ou poliamida)
	Luminaria de acero inoxidable que precisa de un mantenimiento periódico.	Stainless steel luminaire which requires periodical maintenance.	Luminaire de acier inoxydable qui a besoin de maintenance périodique.	Luminária do aço inoxidável que precisa de manutenção periódica.
	Luminaria de latón que precisa de mantenimiento periódico con pulimento específico para recuperar el brillo.	Resin luminaries or posts that require a periodic maintenance with specific polishing to restore the brightness.	Luminaire à laiton qui peut nécessiter d'un entretien à polissage spécifique pour récupérer son aspect d'origine.	Luminária de Latão que precisa de manutenção periódica com polimento específico para recuperar o brilho.
	Luminaria o poste de resina que precisa de mantenimiento periódico con aceite sintético para recuperar el brillo.	Resin luminaries or posts that require a periodic maintenance with synthetic oil to restore the brightness.	Luminaire ou mât à résine qui peut nécessiter d'un entretien à l'huile synthétique pour récupérer son aspect d'origine.	Luminária ou poste de resina que precisa de manutenção periódica com óleo sintético para recuperar o brilho.
	Acabado del poste de acero cincado con lo que debe pintarse forzosamente una vez instalado.	Post is finished in zinc-plated steel and therefore must be painted once installed.	Mât en acier Galvanisé ce qui doit nécessairement être peint une fois installé	Acabamento do poste é em aço zincado, razão por que deve ser pintado forçosamente depois de instalado.
	Posibilidad de aplicar acabados especiales.	Possibility of special finishings.	Autres finitions spéciales possibles.	Possibilidade de acabamentos especiais.
	Vida útil (horas).	Life (hours).	Durée (heures).	Longevidade (horas).
	Índice de reproducción cromática.	Color rendering index.	Index de rendu des couleurs.	Índice de reprodução de cor.
	Respuesta de encendido (seg.)	Power response (sec.).	Réponse d'allumage (sec).	Resposta de ignição (sec).
	Tiempo de carga completa (horas).	Charge Time (hours).	Temps de charge complète (heures).	Tempo de carga completa (horas).
	Autonomía de la batería (horas).	Battery Autonomy (hours).	Autonomie de la batterie (heure).	Autonomia da bateria (horas).
	Incluye mando a distancia.	Include remote control.	Télécommande Incluse.	Inclui comando à distancia.
	Número de colores.	Number of colors.	Nombre de couleurs.	número de cores.
	Número de secuencias de cambio de color.	Number of sequences.	Nombre de séquences de changement de couleur.	Número de sequências de mudança de cor.
	Tramo mínimo de corte (cm)	Minimum cutting section (cm)	Section minimale de découpe (cm)	Seção de corte mínima (cm)
	Longitud máxima de unión de tiras led (10m)	Maximum length interconnected (10m)	Longueur maximale totale des rubans à led connectés (10m)	Longitud máxima de união de tiras led (10m)
	Longitud (5m) de la tira led (mínima unidad de venta)	Standard length (5m) (Minimum Order)	Longueur (5m) du ruban à led (unité de vente minimale)	Longitud (5m) de la tira led (mínima unidad de venta)
	Motor con corriente alterna.	Alternate current motor.	Moteur à courant alternatif.	Motor com corrente alternada.
	Motor con corriente continua.	Direct current motor.	Moteur à courant continu.	Motor com corrente contínua.
	Ventilador con luz.	Fan with lamp.	Ventilateur de plafond lumineux	Ventilador com luz.
	Número de aspas del ventilador.	Number of fan blades.	Nombre d'ailettes du ventilateur.	Numero de pá do ventilador.
	Función inversa para usarlo todo el año.	Inverse function to use it the whole year.	Fonction réversible conçue pour une utilisation toute l'année.	Função inversa para usar todo o ano.
	Regulador de pared.	Wall control.	Variateur mural.	Regulador de parede.

Condiciones de venta

Condições de venta

Condiciones de venta

Todos los pedidos cursados a Grupo Gestión Integral Novolux Internacional, S.L. en adelante "NOVOLUX", implican la aceptación íntegra, por parte del comprador, de las presentes Condiciones Generales de Venta, salvo condiciones particulares pactadas.

1. Precios

Para todo tipo de pedido en **Oferta Comercial Estándar y Bajo Pedido (con referencia en catálogo)** se aplicará la tarifa y condiciones comerciales vigentes en la fecha de recepción de dicho pedido.

Para aquellos pedidos de **Ejecuciones Especiales (sin referencia en catálogo)**, se deberá solicitar una oferta por escrito a NOVOLUX.

Sólo se aplicarán los **precios especiales de las ofertas**, sobre los pedidos íntegros de los mismos. Cualquier alteración sobre la oferta íntegra original por parte del cliente, puede suponer una revisión de las condiciones iniciales de la oferta.

2. Gestión Pedidos

Un pedido no se considerará recepcionado, hasta que la totalidad del mismo se haya cursado correctamente (referencia, color, accesorios, P.V.P. etc.).

El envío de un pedido a NOVOLUX expresara la voluntad de compra por parte del cliente. En el caso que el pedido no pueda ser servido, por el motivo que sea, NOVOLUX informará al cliente de dicha imposibilidad en la mayor brevedad posible. Los pedidos con precios erróneos o discrepancias con las condiciones registradas y/o acordadas por NOVOLUX, no serán tramitados hasta recibir la confirmación escrita del cliente. El correo (e-mail) al cual NOVOLUX solicitará dicha confirmación y aceptación será el que se indique en el pedido recibido del cliente.

Cualquier Pedido recibido que incluya referencias que supongan Ejecuciones Especiales y/o Bajo Pedido requerirá ser aceptado por parte de NOVOLUX, confirmando en factibilidad de producción, precio y plazo de entrega antes de su tramitación. NOVOLUX solicitará el pago por anticipado de, como mínimo, el 30% del valor del pedido (impuestos incluidos).

Los pedidos recibidos que no indiquen lo contrario serán servidos parcialmente en caso de no disponer en stock de la totalidad de los ítems incluidos en él y los portes tendrán la misma condición que el pedido original, entregando los restos de pedido a portes pagados si el pedido ya cumplía la condición inicialmente.

Aquellos pedidos en los que no se indique la voluntad expresa del cumplimiento de un plazo de entrega, serán gestionados según se expone en el punto anterior. En el caso que el cumplimiento del plazo de entrega del pedido total o parcialmente sea requisito indispensable para el cliente, este deberá solicitar plazo de entrega por escrito a NOVOLUX.

Todo pedido inferior a 100€ netos tendrán un cargo de 15€ por gastos de gestión.

3. Devoluciones

Para realizar cualquier devolución, se deberá solicitar autorización previamente a NOVOLUX.

Los productos de **Ejecuciones Especiales, Bajo Pedido o descatalogados no podrán ser devueltos**, ni aun proponiendo una depreciación. Los productos que sean objeto de solicitud de devolución deben haber sido facturados dentro de los 60 días anteriores a la solicitud.

No se aceptarán devoluciones de productos que no estén en perfecto estado para la venta, incluido su embalaje original. Si por esta causa el cliente solicita el retorno de la mercancía devuelta, el envío de retorno será a portes debidos.

El plazo de devolución del material a NOVOLUX, una vez autorizada, será de máximo 10 días.

A todo producto devuelto se le **aplicará la siguiente depreciación sin excepción**:

- Solicitud hasta 30 días posteriores a la fecha de factura..... 10% de depreciación sobre el valor de la devolución, con un mínimo de 20€ por gastos de gestión.
- Solicitud hasta 60 días posteriores a la fecha de factura..... 15% de depreciación sobre el valor de la devolución, con un mínimo de 20€ por gastos de gestión.

4. Entregas / Transportes

Salvo que se acuerden otros términos de transporte, las mercancías viajarán por cuenta y riesgo del comprador en condiciones franco fábrica (EXWORKS para envíos internacionales).

Los pedidos que no lleguen a portes francos mínimos (consulte importe de su zona) y no indiquen medio de transporte del cliente, serán enviados con portes cargados en factura.

No se admitirán reclamaciones por roturas o incidencias en el transporte transcurridas 72 horas desde de la recepción de la mercancía. NOVOLUX sólo se responsabilizará de las incidencias en la entrega, cuando envíe mercancías a portes pagados (a cargo de NOVOLUX).

Los riesgos concernientes a la devolución de las mercancías, correrán siempre a cargo del comprador.

5. Plazos de disponibilidad (franco fábrica)

Los plazos de disponibilidad de mercancía dados por NOVOLUX son siempre aproximados y pueden estar sujetos a variaciones debidas a los propios procesos de gestión de los pedidos, o a terceros responsables del transporte de mercancías y/o suministro de componentes.

Estas posibles variaciones en los plazos, en ningún caso suponen aceptación de responsabilidad o de penalizaciones por demora por parte de NOVOLUX.

6. Servicio especial (CRISTHER 1 hora / DOPO 60 Minutos / EXO 60 Minutos)

Nuestro servicio especial garantiza la preparación del pedido y su puesta a disposición del transitario o transportista designado, en nuestros almacenes en el plazo de 1 hora.

En este servicio los artículos tendrán un cargo de +6%.

Los plazos de transporte no son responsabilidad de NOVOLUX.

7. Proyectos de iluminación

Como servicio adicional a nuestros clientes, disponemos de nuestro propio Departamento Técnico de Proyectos, donde pueden consultar cualquier necesidad lumínica de interior y exterior.

El nivel de prestación de nuestras realizaciones, se adecua a las necesidades de cada proyecto.

8. Muestras

Las muestras de material deberán ser solicitadas mediante pedido y serán facturadas.

El plazo de devolución de las muestras a NOVOLUX, será de un máximo de 30 días desde la fecha que figure en el albarán de entrega y se devolverán a portes pagados.

Las muestras devueltas que no estén en condiciones para la venta (en perfecto estado y con su embalaje original), no podrán ser abonadas.

9. Calidad

Los productos suministrados por NOVOLUX, cumplen con la directiva RoHS 2002/95/CE y con la Norma Europea que marcan las directivas 2006/95/CE indicándose de forma visible tanto en el producto como en su caja exterior. Además, de haber sido sometidos a rigurosos controles de calidad que garantizan su correcto funcionamiento.

NOVOLUX, trabaja permanentemente para mejorar y adecuar sus productos.

Por ello, nos reservamos el derecho a modificar, suprimir o ampliar nuestros productos en catálogo sin previo aviso, y sin que ello sea motivo de reclamaciones.

Dependiendo de los materiales de fabricación y para su máxima optimización en el tiempo, NOVOLUX recomienda realizar los trabajos de mantenimiento con la periodicidad necesaria.

10. Garantía

Todos los productos de NOVOLUX, poseen de un periodo de garantía de 2 años desde la fecha de factura de NOVOLUX.

Bajo solicitud, se puede valorar una extensión de garantía u ofrecer una garantía de proyecto personalizada, tras evaluar las condiciones de aplicación.

En el caso de las lámparas, se garantizarán 2 años, siempre que se cumplan las siguientes condiciones de aplicación:

- Temperatura ambiente de max. -10°C a $+40^{\circ}\text{C}$.
- Min. 10mm de espacio alrededor del cuerpo de la lámpara.
- La instalación eléctrica en la que funcione el producto no debe estar sometida a fluctuaciones de tensión dentro de un intervalo que sobrepase el nominal de la red $\pm 10\%$.
- Máx. 50.000 conmutaciones rápidas (tiempo entre encendido y apagado inferior a 30s).

En caso de no cumplirse estas condiciones, se aplicará la garantía legal de 6 meses contra defectos de fabricación.

El Departamento Técnico de NOVOLUX es el único autorizado para determinar si se trata de un defecto de fabricación, después de recibir por escrito la incidencia, donde se exigirá la factura de venta para verificar la fecha.

La responsabilidad de NOVOLUX cubre la sustitución del producto defectuoso, por el mismo modelo u otro similar, o el abono de su valor en caso de que ya no se fabrique o no se encuentre disponible. No le será exigible ninguna otra responsabilidad por garantía o cualquier otro concepto, explícita o implícita, salvo la aquí establecida.

NOVOLUX no asume la responsabilidad por la mala utilización y/o aplicación de sus productos. Nuestros productos perderán su garantía en caso de que sean manipulados indebidamente o instalados incorrectamente.

Quedan excluidos de la garantía los defectos y deterioros causados por el desgaste o uso, por causa de fuerza mayor, mantenimiento defectuoso, o por el uso inadecuado del producto no especificado ni autorizado previamente por el vendedor.

Las intervenciones a título de garantía no tendrán como efecto la prolongación de la duración de la misma.

11. Reserva de propiedad

NOVOLUX se reserva el derecho de propiedad de todos los materiales que suministre, hasta que el comprador haya hecho efectivo el pago total de los mismos.

12. Jurisdicción

Para cualquier discrepancia o litigio que se derive de las citadas Condiciones Generales de Venta, ambas partes se someten a la competencia de los Juzgados y Tribunales de Barcelona, con expresa renuncia a su fuero propio.

Condições de venda

Todos os pedidos endereçados e registados pelo Grupo Gestión Integral Novolux Internacional, S.L., daqui para a frente "NOVOLUX" implicam a aceitação na íntegra, por parte do comprador, das presentes Condições Gerais de Venda, salvo condições particulares acordadas.

1. Preços

Para todo o tipo de pedido/encomenda em **Oferta Comercial Normal e Sob Pedido (com referencia em catálogo)** se aplicará a tabela de preços vigente na data de recepção da dita encomenda/pedido, com os descontos acordados e em vigor.

Para aqueles pedidos/encomendas de **Execuções Especiais (sem referencia em catálogo)**, se deverá solicitar uma oferta/proposta por escrito a NOVOLUX.

Só se aplicarão os **preços especiais das ofertas**, sobre os pedidos íntegros dos mesmos. Qualquer alteração sobre a oferta/proposta íntegra original por parte do cliente, pode supor uma revisão das condições iniciais da oferta/proposta.

2. Gestão de Pedidos/Encomendas

Um pedido não se considera recepcionado, até que a totalidade do mesmo, tenha sido processado corretamente (referencia, cor, acessórios, P.V.P., etc.).

O envio de um pedido/encomenda à NOVOLUX, expressa a vontade de compra por parte do cliente. No caso em que o pedido não possa ser servido, pelo motivo que seja, NOVOLUX informará o cliente da dita impossibilidade com a maior brevidade possível. Os pedidos com preços errados ou discrepâncias com as condições registadas e/ou acordadas pela Novolux, não serão processados até receber a confirmação escrita do cliente. O correio (e-mail) ao qual NOVOLUX solicitará a dita confirmação e acordo será o que se indica no pedido/encomenda recebido do cliente.

Qualquer pedido/encomenda recebido incluindo referencias que suponham Execuções Especiais deverá ser aceite por parte de NOVOLUX, confirmando a possibilidade de ser executado pela produção, preço e prazo de entrega antes do mesmo ser processado, para sua posterior realização. Novolux solicitará o pagamento antecipado de, pelo menos, 30% do valor do pedido (impostos incluídos).

Os pedidos/encomendas recebidos que não indiquem o contrário serão fornecidos parcialmente em caso de não dispor em stock da totalidade dos itens incluídos nele e os valores de portes terão a mesma condição que o pedido/encomenda original, entregando os restos de pedido/encomenda a portes pagos se o pedido/encomenda já cumpria a condição inicialmente.

Aqueles pedidos/encomendas em que não se indique a vontade expressa do cumprimento de um prazo de entrega, serão geridos segundo se expõe no ponto anterior. No caso que o cumprimento do prazo de entrega do pedido/encomenda total ou parcialmente seja requisito indispensável para o cliente, este deverá solicitar prazo de entrega por escrito a NOVOLUX.

Todo o pedido inferior a 100€ Líquidos terá um custo de 15,00€ para custos de gestão.

3. Devoluções

Para realizar qualquer devolução, dever-se-á solicitar autorização prévia à NOVOLUX.

Os produtos de Execuções Especiais ou Sob Pedido ou descatalogados não podem ser devolvidos, nem mesmo estando sujeitos a uma depreciação.

Os produtos que sejam objeto de solicitação de devolução devem ter sido facturados dentro dos 60 dias anteriores à sua solicitação.

Não se aceitarão devoluções de produtos que não estejam em perfeito estado para a sua venda, incluindo a sua embalagem original. Se por este motivo o cliente solicita o retorno da mercadoria devolvida, o envio de retorno será a portes devidos, ou seja a cargo do cliente.

O prazo de devolução do material à NOVOLUX, uma vez autorizada, será de máximo 10 dias.

A Todo **produto devolvido será aplicada a seguinte depreciação** sem exceção:

- Até 30 dias posteriores à solicitação..... 10% de depreciação sobre o valor da devolução ou 20€ de custos de gestão.
- Até 60 dias posteriores à solicitação.....15% de depreciação sobre o valor da devolução ou 20€ de custos de gestão.

4. Entregas / Transportes

Salvo acordo de outros términos de transporte, as mercadorias viajarão por conta e risco do comprador em condições franco/segundo fábrica (EXWORKS para envios internacionais).

Os pedidos que não cheguem ao valor de portes mínimo acordado e não indiquem o meio de transporte do cliente, serão enviados com o valor dos portes na factura. Não se admitirão reclamações por rupturas ou incidências no transporte transcorridas/passadas 72 horas desde a recepção da mercadoria. NOVOLUX só se responsabilizará pelas incidências na entrega, quando se envie mercadorias a portes pagos (a cargo de NOVOLUX).

Os riscos respeitantes à devolução das mercadorias, serão sempre a cargo do comprador.

5. Prazos de disponibilidade (franco/segundo fábrica)

Os prazos de disponibilidade da mercadoria dados pela NOVOLUX são sempre aproximados e podem estar sujeitos a variações devidas aos próprios processos de gestão dos pedidos/encomendas, ou a terceiros responsáveis do transporte de mercadorias e/ou fornecimento de componentes.

Estas possíveis variações nos prazos, em nenhum caso supõem a aceitação de responsabilidade ou de penalizações por demora por parte da NOVOLUX.

6. Serviço Especial para Espanha e Portugal (CRISTHER 1 hora / DOPO 60 Minutos / EXO 60 Minutos)

O nosso serviço especial garante a preparação do pedido e a sua colocação à disponibilidade do transitário designado nos nossos armazéns no prazo de 1 hora.

Neste serviço os artigos terão um encargo de +6%.

Os prazos de entrega da agência de transporte não são da responsabilidade da NOVOLUX.

7. Projetos de Iluminação

Como serviço adicional aos nossos clientes, dispomos do nosso próprio Departamento Técnico de Projetos, onde podem consultar qualquer necessidade lumínica de interior e exterior.

O nível de prestação das nossas realizações, adequa-se às necessidades de cada projeto.

8. Amostras

As amostras de material deverão ser solicitadas mediante um pedido/encomenda e serão facturadas.

O prazo de devolução das amostras à NOVOLUX, será no máximo de 30 dias a partir da data que figura na Guia de Remessa /Nota de entrega, e serão devolvidas com os portes pagos pelo cliente.

As amostras devolvidas que não estejam em condições para a venda (em perfeito estado e com a sua embalagem original), não poderão ser creditadas.

9. Qualidade

Os produtos fornecidos por NOVOLUX, cumprem com a diretiva RoHS 2002/95/CE e a Norma Europeia que marcam as diretivas 2006/95/CE indicando-se de forma visível tanto no produto como na sua caixa exterior. Apesar, de terem sido submetidos a rigorosos controlos de qualidade que garantem o seu correto funcionamento.

NOVOLUX, trabalha permanentemente para melhorar e adequar os seus produtos.

Por isso, reservamo-nos no direito a modificar, suprimir ou ampliar os nossos produtos sem aviso prévio, e sem que este seja motivo de reclamações.

Dependendo dos materiais de fabricação e para sua máxima optimização no tempo, NOVOLUX recomenda realizar os trabalhos de manutenção com a periodicidade necessária.

10. Garantia

Todos os produtos de NOVOLUX, possuem de um período de garantia de 2 anos a partir do momento da sua compra, ou seja data da factura. Sob pedido, poder-se-á avaliar uma ampliação da garantia a oferecer, ou uma garantia para um projeto específico, após a avaliação e análise da instalação e do ambiente e das condições de aplicação.

No caso das lâmpadas, existe um período de garantia de 2 anos, sempre que se cumpram as seguintes condições de aplicação:

– Temperatura ambiente de max. -10°C a $+ 40^{\circ}\text{C}$.

– Min. 10mm de espaço em redor do corpo da lâmpada.

– A instalação eléctrica em que funciona o produto não deve estar submetida a flutuações/variações de tensão dentro de um intervalo que ultrapasse o valor nominal da rede $\pm 10\%$.

– Máx. 50.000 comutações rápidas (tempo entre o ligado e apagado inferior a 30s)-

Em caso de não se cumprirem estas condições, aplicar-se-á a garantia legal de 6 meses contra defeitos de fabrico.

O Departamento Técnico da Novolux é o único autorizado para determinar se se trata de um defeito de fabrico, depois de receber por escrito a incidência, onde se exigirá a factura de venda bem como a sua data.

A responsabilidade de NOVOLUX cobre a substituição do produto defeituoso, pelo mesmo ou outro similar, ou o crédito do seu valor no caso em que já não se fabrique ou que não se encontre disponível. Não lhe será exigido nenhuma outra responsabilidade por garantia ou qualquer outro conceito, explícita ou implícita, salvo aquela aqui estabelecida.

NOVOLUX não assume a responsabilidade pela má utilização e/ou aplicação dos seus produtos. Os nossos produtos perderão a sua garantia em caso de que sejam manipulados indevidamente ou instalados incorretamente.

Ficam excluídos da garantia os defeitos e deteriorações causados pelo desgaste ou uso, por causa de força maior, manutenção defeituosa, ou pelo uso inadequado do produto não especificado nem autorizado previamente pelo vendedor.

As intervenções a título de garantia não terão como efeito o prolongamento da duração da mesma.

11. Reserva de Propriedade

NOVOLUX reserva-se no direito de propriedade de todos os materiais que fornece, até que o comprador tenha feito o pagamento total dos mesmos.

12. Jurisdição

Para qualquer discrepância ou litígio que derive das citadas Condições Gerais de Venda, ambas partes se submetem à competência dos Juizes e Tribunais de Barcelona, com expressa renúncia ao seu foro próprio.

Índice de referencias

Reference index

Index référence

Referência índice

REF.	PAG	ENERGY CLASS
164C-G23X1D-32	164	A+,A,B,C
164D-G23X1D-32	162	A+,A,B,C
164E-H18X1D-32	162	A+,A,B,C
164F-G23X1D-32	163	A+,A,B,C
164G-G23X1D-32	163	A+,A,B,C
213A-LO102F-30	236	A++,A+,A
213A-L1002F-30	236	A++,A+,A
213B-LO102F-30	236	A++,A+,A
213B-L1002F-30	236	A++,A+,A
367A-LO3E1D-30	238	A++,A+,A
412A-LO103B-40	34	A++,A+,A
412B-LO1E2B-40	34	A++,A+,A
412B-LO1F1B-01	34	A++,A+,A
412B-LO1F1B-40	34	A++,A+,A
419B-LO1D1B-40	38	A++,A+,A
426B-G21X1A-01	32	A++,A+,A,B,C,D,E
426B-G21X1A-02	32	A++,A+,A,B,C,D,E
493A-G04X1A-32	222	A++,A+,A,B,C,D,E
494A-G31X1A-32	229	A++,A+,A,B,C,D,E
495A-G04X1A-28	223	A++,A+,A,B,C,D,E
496A-G04X1A-32	224	A++,A+,A,B,C,D,E
496B-G04X1A-32	224	A++,A+,A,B,C,D,E
497A-LO105A-01	47	A++,A+,A
497A-LO105A-39	47	A++,A+,A
498A-LO105A-01	46	A++,A+,A
499A-G05X1A-39	142	A++,A+,A,B,C,D,E
500A-G05X1A-32	31	-
500A-LO115B-32	31	-
501A-G05X1A-28	30	A++,A+,A,B,C,D,E
501B-G05X1A-28	30	A++,A+,A,B,C,D,E
502A-F02C3B-32	29	A+,A
503A-F0340B-01	26	A+,A,B
503A-F0340B-32	26	A+,A,B
503A-LO140B-01	26	A++,A+,A
503A-LO140B-32	26	A++,A+,A

REF.	PAG	ENERGY CLASS
503B-F03G3B-01	26	A+,A,B
503B-F03G3B-32	26	A+,A,B
503B-LO150B-01	26	A++,A+,A
503B-LO150B-32	26	A++,A+,A
504A-LO108A-01	42	A++,A+,A
504A-LO108A-40	42	A++,A+,A
504B-LO124A-01	42	A++,A+,A
504B-LO124A-40	42	A++,A+,A
504C-LO105A-01	42	A++,A+,A
504C-LO105A-40	42	A++,A+,A
505A-F13B7B-35	24	A++,A+,A,B,C,D,E
505A-LO124A-35	24	A++,A+,A,B,C,D,E
505B-F02C5B-35	24	A++,A+,A,B,C,D,E
505B-LO148B-35	24	A++,A+,A,B,C,D,E
505C-F02F8B-35	24	A++,A+,A,B,C,D,E
505C-LO196B-35	24	A++,A+,A
507A-Y05X1B-35	86	A++,A+,A,B,C,D,E
507A-Y05X1B-46	86	A++,A+,A,B,C,D,E
507B-G05X1A-35	88	A++,A+,A,B,C,D,E
507C-G05X1A-35	208	A++,A+,A,B,C,D,E
507D-G05X1A-35	208	A++,A+,A,B,C,D,E
507E-Y05X1B-35	86	A++,A+,A,B,C,D,E
507F-Y05X1B-35	86	A++,A+,A,B,C,D,E
507F-Y05X1B-46	86	A++,A+,A,B,C,D,E
508A-F02B7B-32	226	A+,A
509A-LO103B-39	66	A++,A+,A
509B-LO103B-39	66	A++,A+,A
510A-Y04X1B-35	94	A++,A+,A
511A-LO103H-29	219	A++,A+,A
513A-LO109B-32	227	A++,A+,A
513B-LO112B-32	227	A++,A+,A
514A-LO109A-32	228	A++,A+,A
514B-LO112A-32	228	A++,A+,A
515A-LO1D2B-32	234	A++,A+,A
515B-LO103B-32	234	A++,A+,A

REF.	PAG	ENERGY CLASS
516A-Y04X1B-32	95	A++,A+,A,B,C,D,E
517B-L0103B-35	68	A++,A+,A
517B-L0103B-46	68	A++,A+,A
517D-L0103B-35	68	A++,A+,A
517E-L0103B-35	68	A++,A+,A
517E-L0103B-46	68	A++,A+,A
518A-L0103A-35	69	A++,A+,A
518B-L0103A-35	69	A++,A+,A
584A-L0105A-01	48	A++,A+,A
584B-L01H4A-01	130	A++,A+,A
585A-G05X1A-02	150	A++,A+,A,B,C,D,E
586A-G05X1A-01	156	A++,A+,A,B,C,D,E
588A-L0104A-02	70	A++,A+,A
588B-L0104A-02	204	A++,A+,A
589A-G05X1A-35	54	-
589A-L0124A-35	54	-
590A-F0322B-32	28	-
590A-L0124A-32	28	-
591A-L01H5A-32	220	A++,A+,A
591B-L0104A-32	220	A++,A+,A
592A-L0105A-03	62	A++,A+,A
593A-L0108A-01	160	A++,A+,A
593A-L0108A-03	160	A++,A+,A
594A-G05X1A-01	120	A++,A+,A,B,C,D,E
595A-G05X1A-35	78	A++,A+,A,B,C,D,E
596A-Y05X1A-32	95	A++,A+,A
596B-Y05X1A-32	210	A++,A+,A
596C-Y05X1A-32	210	A++,A+,A
597A-G05X1A-01	121	A++,A+,A,B,C,D,E
598A-L0124B-35	200	A++,A+,A
600A-Y05X1A-35	92	A++,A+,A
600B-G05X1A-35	92	A++,A+,A,B,C,D,E
600C-G05X1A-35	92	A++,A+,A,B,C,D,E
600D-G05X1A-35	215	A++,A+,A,B,C,D,E
600E-G05X1A-35	214	A++,A+,A,B,C,D,E

REF.	PAG	ENERGY CLASS
600F-G05X1A-35	214	A++,A+,A,B,C,D,E
600G-G05X1A-35	93	A++,A+,A
601A-G05X1A-32	158	-
601A-G05X1A-37	158	-
602A-G05X1A-32	206	A++,A+,A,B,C,D,E
602B-G05X1A-32	207	A++,A+,A,B,C,D,E
603A-L0105A-32	70	A++,A+,A
605A-G04X1A-10	143	A++,A+,A,B,C,D,E
606A-L0105A-01	231	A++,A+,A
606B-L01G2A-01	231	A++,A+,A
607A-G05X1A-35	188	A++,A+,A,B,C,D,E
608A-G05X1A-40	159	A++,A+,A,B,C,D,E
610A-G05X1A-42	156	A++,A+,A,B,C,D,E
611A-Y05X1A-35	90	A++,A+,A,B,C,D,E
611B-G05X1A-35	90	A++,A+,A,B,C,D,E
611C-G05X1A-35	90	A++,A+,A,B,C,D,E
611D-G05X1A-35	213	A++,A+,A,B,C,D,E
611E-G05X1A-35	212	A++,A+,A,B,C,D,E
611F-G05X1A-35	212	A++,A+,A,B,C,D,E
612A-G05X1A-32	52	A++,A+,A,B,C,D,E
612A-L0112A-32	52	A++,A+,A
613A-L0105A-01	47	A++,A+,A
614A-G05X1A-02	182	A++,A+,A,B,C,D,E
614B-G05X1A-02	182	A++,A+,A,B,C,D,E
615A-G05X1A-32	184	A++,A+,A,B,C,D,E
616A-L0103A-40	62	A++,A+,A
617A-L0105A-39	204	A++,A+,A
618A-G05X1A-02	154	A++,A+,A,B,C,D,E
620A-G05X1A-02	150	A++,A+,A,B,C,D,E
621A-G05X1A-50	174	A++,A+,A,B,C,D,E
621B-G05X1A-50	174	A++,A+,A,B,C,D,E
622A-G05X1A-02	186	A++,A+,A,B,C,D,E
623A-L0103A-32	220	A++,A+,A
624A-L0103A-35	72	A++,A+,A
625A-L0106A-35	72	A++,A+,A

REF.	PAG	ENERGY CLASS
625B-LO112A-35	72	A++,A+,A
626A-G05X1A-32	54	A++,A+,A,B,C,D,E
633A-LO11H8A-35	202	A++,A+,A
634A-H35X1A-01	40	A++,A+,A
634A-H35X1A-03	40	A++,A+,A
634A-LO113B-01	40	A++,A+,A
634A-LO113B-03	40	A++,A+,A
634B-LO113B-01	40	A++,A+,A
634B-LO113B-03	40	A++,A+,A
635A-WL58B-01	246	A++,A+,A
635A-WL58B-03	246	A++,A+,A
636A-WL75B-51	244	A++,A+,A
637A-WL90B-07	243	-
638A-VX60B-01	242	-
638B-VX82B-01	242	-
677A-LO205B-32	232	A++,A+,A
678A-LO206B-32	232	A++,A+,A
679A-LO129B-35	198	A++,A+,A
680A-G04X1A-13	74	-
680B-G04X1A-13	144	-
680C-G05X1A-13	144	-
680D-G04X1A-13	192	-
680E-G04X1A-13	192	-
681A-G05X1A-02	77	A++,A+,A,B,C,D,E
681B-G05X1A-02	178	A++,A+,A,B,C,D,E
681C-G05X1A-02	178	A++,A+,A,B,C,D,E
682A-G05X1A-91	152	A++,A+,A,B,C,D,E
683A-G04X1A-03	110	A++,A+,A,B,C,D,E
683B-G04X1A-03	110	A++,A+,A,B,C,D,E
684A-G05X1A-02	114	A++,A+,A,B,C,D,E
685A-G05X1A-02	112	A++,A+,A,B,C,D,E
685B-G05X1A-02	112	A++,A+,A,B,C,D,E
686A-G05X1A-44	116	A++,A+,A,B,C,D,E
687A-G05X1A-01	118	A++,A+,A,B,C,D,E
687A-G05X1A-37	118	A++,A+,A,B,C,D,E

REF.	PAG	ENERGY CLASS
688A-G05X1A-51	180	A++,A+,A,B,C,D,E
689A-LO124A-40	56	A++,A+,A
690A-LO112A-35	56	A++,A+,A,B,C,D,E
691A-LO116A-40	44	-
692A-LO106A-01	58	A++,A+,A
692A-LO106A-32	58	A++,A+,A
693A-LO112A-35	52	A++,A+,A
694A-LO112A-35	57	A++,A+,A
695A-LO112A-01	44	A++,A+,A
695A-LO112A-32	44	A++,A+,A
696A-LO107A-32	230	A++,A+,A
697A-LO106B-01	50	A++,A+,A
698A-LO105B-37	126	A++,A+,A
699A-LO105B-37	125	A++,A+,A
700A-LO106B-32	60	A++,A+,A
701A-G05X1A-91	196	A++,A+,A,B,C,D,E
701B-G05X1A-91	196	A++,A+,A,B,C,D,E
702A-G05X1A-91	194	A++,A+,A,B,C,D,E
702B-G05X1A-91	194	A++,A+,A,B,C,D,E
703A-G05X1A-51	176	A++,A+,A,B,C,D,E
704A-LO103B-01	61	A++,A+,A
705A-LO103B-01	61	A++,A+,A
705A-LO103B-02	61	A++,A+,A
707A-LO105A-32	230	A++,A+,A
708A-Y05X1A-32	84	A++,A+,A,B,C,D,E
709A-Y05X1A-35	85	A++,A+,A,B,C,D,E
710A-LO103A-02	67	A++,A+,A
710A-LO103A-07	67	A++,A+,A
710B-LO103A-02	67	A++,A+,A
710B-LO103A-07	67	A++,A+,A
711A-LO106A-01	36	A++,A+,A
712A-G04X1A-46	223	A++,A+,A,B,C,D,E
713A-LO106A-01	37	A++,A+,A
714A-G21X1A-32	75	A++,A+,A,B,C,D,E
714B-G21X1A-32	75	A++,A+,A,B,C,D,E

REF.	PAG	ENERGY CLASS
715A-L0125A-01	22 132	A++,A+,A
715A-L0125A-02	22 132	A++,A+,A
715A-L0125A-03	22 132	A++,A+,A
715B-L3135A-01	22 132	A+
715B-L3135A-02	22 132	A+
715B-L3135A-03	22 132	A+
716A-G05X1A-03	134	A++,A+,A,B,C,D,E
716A-G05X1A-07	134	A++,A+,A,B,C,D,E
716A-G05X1A-09	134	A++,A+,A,B,C,D,E
716A-G05X1A-29	134	A++,A+,A,B,C,D,E
716B-G05X1A-03	136	A++,A+,A,B,C,D,E
716B-G05X1A-07	136	A++,A+,A,B,C,D,E
716B-G05X1A-09	136	A++,A+,A,B,C,D,E
716B-G05X1A-29	136	A++,A+,A,B,C,D,E
717A-G05X1A-02	170	A++,A+,A,B,C,D,E
717A-G05X1A-32	170	A++,A+,A,B,C,D,E
717B-G05X1A-02	171	A++,A+,A,B,C,D,E
717B-G05X1A-32	171	A++,A+,A,B,C,D,E
717C-G05X1A-02	82	A++,A+,A,B,C,D,E
717C-G05X1A-32	82	A++,A+,A,B,C,D,E
717D-G05X1A-01	138	A++,A+,A,B,C,D,E
717D-G05X1A-02	138	A++,A+,A,B,C,D,E
717D-G05X1A-32	138	A++,A+,A,B,C,D,E
717E-G05X1A-01	138	A++,A+,A,B,C,D,E
717E-G05X1A-02	138	A++,A+,A,B,C,D,E
717E-G05X1A-32	138	A++,A+,A,B,C,D,E
717F-G05X1A-01	138	A++,A+,A,B,C,D,E
717F-G05X1A-02	138	A++,A+,A,B,C,D,E
717F-G05X1A-32	138	A++,A+,A,B,C,D,E
717G-G05X1A-02	80	A++,A+,A,B,C,D,E
717G-G05X1A-03	80	A++,A+,A,B,C,D,E
719A-G04X1A-01	122	A++,A+,A,B,C,D,E
719A-G04X1A-02	122	A++,A+,A,B,C,D,E
719A-G04X1A-07	122	A++,A+,A,B,C,D,E
719B-G04X1A-01	122	A++,A+,A,B,C,D,E

REF.	PAG	ENERGY CLASS
719B-G04X1A-02	122	A++,A+,A,B,C,D,E
719B-G04X1A-07	122	A++,A+,A,B,C,D,E
719C-G04X1A-01	122	A++,A+,A,B,C,D,E
719C-G04X1A-02	122	A++,A+,A,B,C,D,E
719C-G04X1A-07	122	A++,A+,A,B,C,D,E
720A-G05X1A-50	108	A++,A+,A,B,C,D,E
720B-G05X1A-50	108	A++,A+,A,B,C,D,E
721A-G05X1A-94	128	A++,A+,A,B,C,D,E
721A-G05X1A-95	128	A++,A+,A,B,C,D,E
721B-G05X1A-92	129	A++,A+,A,B,C,D,E
723A-G04X1A-CM	133	A++,A+,A,B,C,D,E
723B-G04X1A-CM	76	A++,A+,A,B,C,D,E
724A-G05X1A-53	106	A++,A+,A,B,C,D,E
724A-G05X1A-54	106	A++,A+,A,B,C,D,E
725A-G05X1A-29	124	A++,A+,A,B,C,D,E
727A-Y05X1B-01	64	A++,A+,A,B,C,D,E
727B-G05X1A-01	64	A++,A+,A,B,C,D,E
727C-Y05X1B-01	64	A++,A+,A,B,C,D,E
728A-G05X1A-02	140	A++,A+,A,B,C,D,E
728A-G05X1A-35	140	A++,A+,A,B,C,D,E
728A-G05X1A-37	140	A++,A+,A,B,C,D,E
837A-G05X1A-01	168	A++,A+,A,B,C,D,E
837B-G05X1A-01	168	A++,A+,A,B,C,D,E
837C-G05X1A-01	98	A++,A+,A,B,C,D,E
838A-G05X1A-54	104	A++,A+,A,B,C,D,E
840A-G05X1A-55	102	A++,A+,A,B,C,D,E
840A-G05X1A-56	102	A++,A+,A,B,C,D,E
840B-G05X1A-55	100	A++,A+,A,B,C,D,E
840B-G05X1A-56	100	A++,A+,A,B,C,D,E
841A-Y05X1A-35	83	A++,A+,A,B,C,D,E
842A-L0103B-01	59	A++,A+,A
842A-L0103B-35	59	A++,A+,A
843A-G05X1A-01	148	A++,A+,A,B,C,D,E
844A-G05X1A-01	146	A++,A+,A,B,C,D,E
844A-G05X1A-03	146	A++,A+,A,B,C,D,E

REF.	PAG	ENERGY CLASS
845A-G05X1A-50	172	A++,A+,A,B,C,D,E
845B-G05X1A-50	172	A++,A+,A,B,C,D,E
846A-G05X1A-01	148	A++,A+,A,B,C,D,E
846B-G05X1A-01	74	A++,A+,A,B,C,D,E
846C-G05X1A-01	190	A++,A+,A,B,C,D,E
A12A-509-01	66	-
A15B-164-03	165	-
A15C-164-03	165	-
A20A-715-01	132	-
A20A-715-02	132	-
A20A-715-03	132	-
A20B-715-01	22	-
A20C-715-01	22	-
A26A-004-CA	86,88	-
A26A-004-CB	86,88	-
A26A-004-CC	86,88	-
A26A-516-CA	95	-
A26A-516-CC	95	-
A26B-004-CA	172 208	-
A26B-004-CB	172 208	-
A26B-004-CC	172 208	-
A26C-004-CA	208	-
A26C-004-CB	208	-
A26C-004-CC	208	-
A26D-004-CA	95	-
A26D-004-CC	95	-
A26E-004-CA	82	-
A26E-004-CC	82	-
A26E-004-CE	82	-
A26E-004-CJ	82	-
A26E-004-CK	82	-
A26E-004-HC	82	-
A26F-004-CA	170	-
A26F-004-CC	170	-
A26F-004-CE	170	-

REF.	PAG	ENERGY CLASS
A26F-004-CJ	170	-
A26F-004-CK	170	-
A26F-004-HC	170	-
A26G-004-CA	171 172	-
A26G-004-CC	171 172	-
A26G-004-CE	171	-
A26G-004-CJ	171	-
A26G-004-CK	171	-
A26G-004-HC	171	-
A27A-004-CA	86,88	-
A27A-004-CB	86,88	-
A27A-004-CC	86,88	-
A27B-004-CA	208	-
A27B-004-CB	208	-
A27B-004-CC	208	-
A27C-004-CA	208	-
A27C-004-CB	208	-
A27C-004-CC	208	-
A28A-004-CA	90 212	-
A28A-004-CC	90 212	-
A28B-004-CA	213	-
A28B-004-CC	213	-
A28C-004-CA	212	-
A28C-004-CC	212	-
A28E-004-CA	84	-
A28E-004-CC	84	-
A29A-004-CA	94	-
A29A-004-CC	94	-
A29B-004-CG	174	-
A29B-004-DC	174	-
A29C-004-CG	174	-
A29C-004-DC	174	-
A29D-004-CA	176 180	-
A30A-004-CA	94	-
A30A-004-CC	94	-

REF.	PAG	ENERGY CLASS
A30B-004-CA	92	-
A30B-004-CC	92	-
A30C-004-CA	83	NP
A30C-004-CC	83	NP
A32A-004-CA	78 184	-
A32A-004-CC	78 184	-
A32B-004-CA	80 134	-
A32B-004-CC	80 134	-
A32B-004-CE	80 134	-
A32B-004-CJ	80 134	-
A32B-004-CJ	80 134	-
A32B-004-CK	80 134	-
A32B-004-HC	80 134	-
A32B-004-HC	80 134	-
A32C-004-CA	80 134	-
A32C-004-CA	80 134	-
A32C-004-CC	80 134	-
A32C-004-CE	80 134	-
A32C-004-CJ	80 134	-
A32C-004-CK	80 134	-
A32C-004-CK	80 134	-
A32C-004-HC	80 134	-
A32C-004-HC	80 134	-
A32D-004-CA	134	-
A32D-004-CC	134	-
A32D-004-CE	134	-
A32D-004-CJ	134	-
A32D-004-CK	134	-
A32D-004-HC	134	-
A33A-004-CA	206	-
A33A-004-CB	206	-
A33B-004-CA	207	-
A33B-004-CB	207	-
A35A-004-CA	178	-
A35C-004-CA	77 178	-

REF.	PAG	ENERGY CLASS
A36A-004-CA	215	-
A36A-004-CC	215	-
A36B-004-CA	214	-
A36B-004-CC	214	-
A36C-004-CA	214	-
A36C-004-CC	214	-
A36D-004-CA	93	-
A36D-004-CC	93	-
A36E-004-CA	85	-
A36E-004-CC	85	-
B08A-X33X2D-03	165	-
B08H-X33X2D-03	165	-

REF.	PAG	ENERGY CLASS
368C-L2305D-01	261	A++,A+,A
369C-L2308D-01	261	A++,A+,A
369C-L2308D-02	261	A++,A+,A
369D-L2003B-01	261	A++,A+,A
369D-L2003B-02	261	A++,A+,A
371A-L3309B-01	261	A++,A+,A
378A-L3103A-01	259	A++,A+,A
378A-L3103A-02	259	A++,A+,A
378A-L3104A-01	259	A++,A+,A
378A-L3106A-01	259	A++,A+,A
378A-L3106A-02	259	A++,A+,A
378B-L3107A-01	259	A++,A+,A
378B-L3107A-02	259	A++,A+,A
378B-L3110A-01	259	A++,A+,A
378B-L3110A-02	259	A++,A+,A
378C-L3111A-01	259	A++,A+,A
378C-L3111A-02	259	A++,A+,A
464A-L0124F-00	250	A++,A+,A
464A-L0172F-00	250	A++,A+,A
464A-L0224F-00	250	A++,A+,A
464A-L0472F-00	251	A++,A+,A
464B-L0105F-00	250	A++,A+,A
464B-L0115F-00	250	A++,A+,A
464B-L0205F-00	250	A++,A+,A
464B-L0415F-00	251	A++,A+,A
464C-L0172F-00	250	A++,A+,A
464D-L0115F-00	250	A++,A+,A
465A-L0124F-29	253	A++,A+,A
465B-L0172F-29	252	A++,A+,A
465C-L0115F-29	252	A++,A+,A
465D-L0172F-29	252	A++,A+,A
465E-L0115F-29	252	A++,A+,A
465F-L0124F-29	252	A++,A+,A
465F-L0224F-29	252	A++,A+,A
465F-L0472F-29	253	A++,A+,A
465G-L0105F-29	252	A++,A+,A
465G-L0205F-29	252	A++,A+,A
465G-L0415F-29	253	A++,A+,A
578A-L2104A-01	261	A++,A+,A
578A-L2104A-02	261	A++,A+,A
578A-L2105A-01	261	A++,A+,A
578A-L2105A-02	261	A++,A+,A
583A-L0140B-01	264	A++,A+,A
583A-L0240B-01	264	A++,A+,A
583B-L0140B-01	264	A++,A+,A
583B-L0240B-01	264	A++,A+,A
599A-L0118B-01	263	A++,A+,A
599A-L0124B-01	263	A++,A+,A

REF.	PAG	ENERGY CLASS
599A-L0218B-01	263	A++,A+,A
599A-L0224B-01	263	A++,A+,A
599A-L0318B-01	263	A++,A+,A
609A-L0109A-03	261	A++,A+,A
632C-L0504B-01	260	A++,A+,A
632C-L0506B-01	260	A++,A+,A
632C-L0507B-01	260	A++,A+,A
632D-L0404B-01	260	A++,A+,A
632E-L0404B-01	260	A++,A+,A
632F-L0504B-01	260	A++,A+,A
632G-L0504B-01	260	A++,A+,A
A17A-322-03	267	-
A17B-322-01	267	-
A17C-322-01	267	-
A17C-322-02	267	-
A17D-322-01	267	-
A17D-322-02	267	-
A17E-322-01	267	-
A17E-322-02	267	-
A17E-322-03	267	-
A20B-583-01	264	-
A20B-583-38	264	-
A50A-778-39	256	NP
A50B-778-39	256	NP
A50C-778-00	256	NP
A50D-778-00	256	NP
A50E-778-39	256	NP
A50F-778-39	256	NP
A50G-778-03	256	NP
A50H-778-03	256	NP
A50I-778-00	256	NP
A51A-778-39	257	NP
A51B-778-39	257	NP
A51C-778-00	257	NP
A51D-778-00	257	NP
A51E-778-39	257	NP
A51F-778-39	257	NP
A51G-778-03	257	NP
A51H-778-03	257	NP
A51I-778-00	257	NP
A52A-778-39	258	
A52B-778-39	258	NP
A52C-778-00	258	
A52D-778-00	258	
A52E-778-39	258	NP
A52F-778-39	258	NP
A52G-778-03	258	
A52H-778-03	258	

REF.	PAG	ENERGY CLASS
A52I-778-00	258	
B02A-X3317H-01	268	-
B02A-X3317J-01	268	
B02A-X3320I-01	268	
B02A-X33X2F-01	268	-
B02B-X3360B-01	268	-
B02B-X33A2B-01	268	-
B02B-X33A4B-01	268	-
B02C-X33A7D-02	268	-
B02F-X33A8D-32	268	-
B02G-X3306J-01	268	-
B02I-X33F9D-02	268	-
B02I-X33G1D-02	268	-
B02J-X3350D-02	268	-
B02M-X33A5D-03	268	-
B02M-X33A9D-03	268	-
B02N-X3320M-01	268	-
B02O-X3340F-39	269	-
B02O-X3380F-39	269	-
B02O-X33A1F-39	269	-
B02O-X33A4F-39	269	-
B02Q-X3312F-01	269	-
B02Q-X3325F-01	269	-
B02R-X33A1F-01	269	-
B02S-X3360E-32	269	-
B02V-X3335F-00	269	NP
B02V-X3360F-00	269	NP
B02V-X3396F-00	269	NP
B02V-X33A4F-00	269	NP
B02W-X3360F-00	269	NP
B02X-X33J2F-00	269	
B02Y-X3360F-00	269	NP
B02Y-X33A1F-00	269	NP
B02Y-X33A4F-00	269	NP
B03A-X33X2A-02	262	-
B03B-X33X2A-02	262	-
B03C-X33X2A-02	262	-
B03D-X33X2A-02	262	-
B04A-X33X2B-01	262	-
B04A-X33X2B-02	262	-
B04B-X33X2B-01	262	-
B04B-X33X2B-02	262	-
B05E-C33A7F-39	253	-
B05F-C33A9F-39	251	-
B05G-C33A8F-39	253	-
B05H-C33A7F-39	251	-
B05I-X33J3F-00	254	
B05J-X33J4F-00	255	

REF.	PAG	ENERGY CLASS
B05K-X33J4F-00	255	
B05L-X33X2E-00	254	
B05M-X33X2F-00	254	
B05N-X33X2X-00	255	
B10A-X33X2A-01	266	-
B10A-X33X2A-02	266	-
B10A-X33X2A-03	266	-
B10B-X33X2A-01	266	-
B10B-X33X2A-02	266	-
B10B-X33X2A-03	266	-
B10C-X33X2A-01	266	-
B10C-X33X2A-02	266	-
B10C-X33X2A-03	266	-
B10D-X33X2A-01	266	-
B10D-X33X2A-02	266	-
B10D-X33X2A-03	266	-
B10E-X33X2A-01	267	-
B10E-X33X2A-02	267	-
B10E-X33X2A-03	267	-
B10F-X33X2A-01	267	-
B10F-X33X2A-02	267	-
B10F-X33X2A-03	267	-
B10G-X33X2A-01	267	-
B10G-X33X2A-02	267	-
B10G-X33X2A-03	267	-
B10H-X33X2A-01	267	-
B10H-X33X2A-02	267	-
B10H-X33X2A-03	267	-
B10I-X33X2A-01	267	-
B10I-X33X2A-02	267	-
B10I-X33X2A-03	267	-
B10J-X33X2A-01	267	-
B10J-X33X2A-02	267	-
B10J-X33X2A-03	267	-
B10K-X33X2A-01	267	-
B10K-X33X2A-02	267	-
B10K-X33X2A-03	267	-
B10L-X33X2A-01	267	-
B10L-X33X2A-02	267	-
B10L-X33X2A-03	267	-
B10N-X33X2A-01	267	-
B10N-X33X2A-02	267	-
B10N-X33X2A-03	267	-
B10O-X33X2A-01	267	-
B10O-X33X2A-02	267	-
B10P-X33X2A-01	267	-
B10P-X33X2A-02	267	-
B10P-X33X2A-03	267	-



convertimos tus ideas en luz
Lighting your ideas



**TUS IDEAS
Y NECESIDADES**
YOUR IDEAS AND NEEDS



**NUESTRO DESARROLLO
Y FABRICACIÓN**
OUR DEVELOPMENT AND MANUFACTURING



**LUMINARIA
SINGULAR Y ÚNICA**
ORIGINAL AND UNIQUE LUMINAIRE



Si eres diseñador, interiorista, decorador, arquitecto o creativo y buscas diferenciarte de lo estándar, GRUPONOVOLUX tiene la experiencia para desarrollar y fabricar cualquier luminaria a medida.

If you are a lighting designer, interior designer, decorator or architect in the search of being different, GRUPO NOVOLUX offers the experience to develop any bespoke luminaire.

Nuestro equipo cuenta con diseñadores, ingenieros y artesanos que con su know-how y continua búsqueda de tendencias podrán hacer realidad cualquier producto en exclusiva.

Our team, of designers, engineers and craftsmen with a wide know-how and searching for the new trends, can make any product unique.



GRUPO | **NOVOLUX** LIGHTING

lighting from Barcelona

Cristher lighting
architectural outdoor

Dopo lighting
residential outdoor

exo lighting
decorative indoor

indeluz lighting
technical indoor

exo lighting

Edición:
Publication:
Édition:
Edição:

11 / 2017

Concepto gráfico, maquetación y preimpresión:
Graphic concept, layout and prepress:
Concept graphique, mise en page et pré-impresion:
Design gráfica, maquetação e pré-impresão:

Grupo Novolux

Descarga del catalogo
Download the catalogue
Catalogue téléchargeable
Transferência do catálogo



LIGHTING
GRUPO|NOVOLUX
lighting from Barcelona

Cristher^{lighting}
architectural outdoor

Dopo^{lighting}
residential outdoor

exo^{lighting}
decorative indoor

indeluz^{lighting}
technical indoor

www.gruponovolux.com

Marcas registradas de: / Are registered trade marks of: / Ce sont des marques enregistrées de:
GRUPO GESTIÓN INTEGRAL NOVOLUX INTERNACIONAL, S.L.